

**AISIN ADVICS**

**AISIN**  
*Geared up for the future*

**PREMIUM**

**BRAKE SYSTEM CATALOGUE  
2010-2011**



# AISIN

One Team, Best Future

# AISIN ADVICS

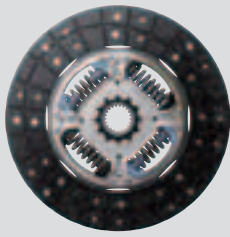

Clutch Disc



Clutch Cover

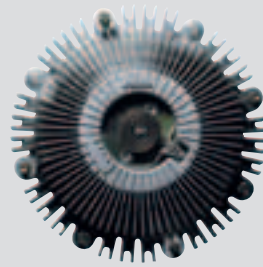

Fan Clutch



Free Wheel Hub

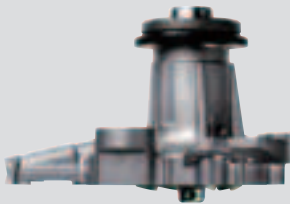

Water Pump



Oil Pump



Clutch Release Cylinder



Hydraulic Belt Tensioner

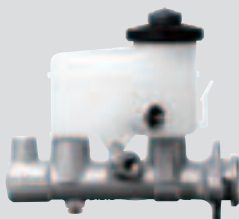

Brake Master Cylinder



Brake Wheel Cylinder



Brake Booster



Brake Pads

## Meet the AISIN Family



# IMPORTANT NOTICE

The purpose of this publication is to furnish our customers with as complete a listing of their new brake system parts requirements as possible.

All listings, applications or interchanges contained in this publication are based on the latest information available at the time of printing. Every effort has been made to ensure that the information contained in this publication is correct, but we do not assume any responsibility for errors which may occur.

Cross references of car or part manufacturers are given for comparison purpose only. The use of such information on invoices is not allowed. All rights reserved. Reproduction or use of this publication -even in part- for the purpose of creating a catalogue is not allowed.





# INDEX



05

APPLICATION LIST

BRAKE PADS DRAWINGS

...

...

BRAKE SYSTEM PICTURES

CROSS REFERENCE LIST

...





# APPLICATION LIST



ASIA	06	
	06	CHEVROLET/DAEWOO
	06	CITROEN
DAIHATSU	06	
	10	FIAT
	10	FORD
HONDA	12	
HYUNDAI	20	
	24	INFINITI
	26	ISUZU
KIA	26	
	26	LEXUS
MAZDA	28	
MITSUBISHI	34	

	42	NISSAN
OPEL	54	
	60	PEUGEOT
	60	PROTON
RENAULT	60	
ROVER	60	
	62	SAO
	62	SUBARU
	64	SUZUKI
TOYOTA	66	
	92	VAUXHALL
	94	VOLKSWAGEN
	94	VOLVO
XEDOS	96	





CCM

Body Type



Brake Code



Brake Pads Front



Brake Pads Rear

## ASIA

ROCSTA	1991.10		JF8	1789		G	AKE		
	1994.08			2184		D	AKE		
	1990.02		R2	2184		D	AKE		

## CHEVROLET/DAEWOO

AVEO	2008.04			1206	hatchback	G			
CAPTIVA	2006.06		Z24SED	2405	2WD + 4WD	G			
ESPERO	1993.09	1996.08	A15MF	1498	N1411	G	ATE		
	1996.08		A15MF	1498	N1411	G	ATE		
	1993.09	1995.10	C18LE	1796		G	ATE		
	1995.11		C18LE	1796		G	ATE		
	1993.09	1995.10	C20LE	1998	N2431	G	ATE		
	1995.11		C20LE	1998	N2431	G	ATE		
KALOS	2002.08		B12S1	1150	KLAS	G			
	2005.03		B12S1	1150		G			
	2003.04		F14D3	1399	SF48A1 16V	G			
LANOS	1997.08	2004.12	A13SM	1349	TFC	G	ATE		
	1996	2000	A15SMS	1498	TF, TA48Y	G	ATE		
	1997.05	2004.03	16DMS	1598	TA, TF6	G	ATE+ABS		
MATIZ	2005.03		F8CV	796	M200, KLAK	G			
	1998.08	2005.03	FC8V	796	KLYA, Y4A11, M100	G	LUC		
	2002		B10S	995	KLYA	G			
	2005.03		B10S	995	M200	G			
NEXIA	1995.03	1996.08	A15MF	1498	311, 511, 411 16V	G	ATE		
	1996.08		A15MF	1498	311, 511, 411 16V	G	ATE		
	1995.03	1996.08	G15MF	1498	322, 522, 422 8V	G	ATE		
	1996.08		G15MF	1498	322, 522, 422 8V	G	ATE		
NUBIRA	1997.06	2004.09	16DMS	1598	JF/JA	G			
	1997.09	2004.09	16DMS	1598	for Poland	G	ATE+ABS		
	1997.09		X20S	1998	8V	G			
	1997.06		X20SED	1998	JF/JA 16V	G			

## CITROEN

ZX	1993.06	1997.06	161A	1769	N2	D			
	1993.06	1997.06	161A (XUD7)	1769	N2	D			

## DAIHATSU

APPLAUSE	1989.06	1990.09		1589	A101 to chassis 623399	G	SUM		G2N010
	1990.09	1995.10		1589	A101 frm chassis 628399	G	SUM		G2N010
	1989.06	1994.04		1589	A111 4WD	G			G2N010



Brake Master Cylinder

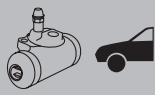

Brake Wheel Cylinder Front

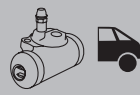

Brake Wheel Cylinder Rear Left

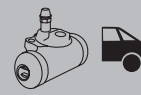

Brake Wheel Cylinder Rear Right

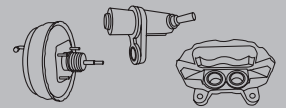

Other Parts

		A: AK-003	A: AK-003	
		A: AK-003	A: AK-003	
		A: AK-003	A: AK-003	

		A: AO-003	A: AO-003	
MD-009				
		A: AE-OP02	A: AE-OP02	
		A: AE-OP02	A: AE-OP02	
		A: AE-OP02	A: AE-OP02	
		A: AE-OP02	A: AE-OP02	
		A: AE-OP02	A: AE-OP02	
		A: AE-OP02	A: AE-OP02	
		A: AO-003	A: AO-003	
		A: AO-003	A: AO-003	
		A: AO-003	A: AO-003	
MO-007		A: AE-OP01	A: AE-OP01	
MO-007		A: AE-OP01	A: AE-OP01	
MO-009		A: AO-002	A: AO-002	
MO-004		A: AO-001	A: AO-001	
MO-022		A: AO-001	A: AO-001	
MO-004		A: AO-001	A: AO-001	
		A: AO-001	A: AO-001	
		A: AE-OP02	A: AE-OP02	
		A: AE-OP02	A: AE-OP02	
		A: AE-OP01	A: AE-OP01	
		A: AE-OP01	A: AE-OP01	
MO-021		A: AO-002	A: AO-002	
MO-021		A: AO-002	A: AO-002	
MO-021				
MO-021		A: AO-002	A: AO-002	

MZ-056				
ME-CI01				

MD-008		A: AD-010L	A: AD-010R	
MD-008		A: AD-010L	A: AD-010R	
		A: AD-010L	A: AD-010R	

APPLICATION LIST





CCM

Body Type



Brake Code



Brake Pads Front



Brake Pads Rear

# DAIHATSU

APPLICATION LIST

CHARADE	1983.01	1987.12		993	G11	G	AKE		
	1986.12	1993.01		993	G100	G	SUM		
	1986.12	1993.01		993	G100 GTI T	G			
	1983.01	1987.12		993	G30	D	AKE		
	1983.01	1986.12		993	G30 T	D			
	1986.12	1993.01		993	G101	D			
	1986.12	1993.01		993	G101 T	D			
	1988.01	1993.01		1295	G102S, G112S	G	SUM		
	1993.01	1996.06		1296	G200	G	AKE/AKE		E2N032
	1996.06	2000.09		1296	G200	G			E2N032
	1993.07	2000.03		1499	G203S, G213S	G	AKE/AKE	G1N017	E2N032
	1996.12	1998.07		1589	G201 GTI	G		G1N017	E2N032
CHARMANT	1977.08	1980.08		1407	A20	G			
	1980.08	1983.08		1588	A40, A45	G			
	1983.08	1984.09		1588	A40, A45	G			
COPEN	2006.03		1298		G		G1N006		
CUORE	1985.09	1990		846	L80 see DOMINO	G			
DOMINO	1985.09	1990.		846	L80	G			
	1985.09	1990		846	L81 4WD	G			
	1990.08	1994.12		846	L201	G			
FEROZA 4X4	1988.01	1990.08		1589	F300/F310	G	AKE		
	1990.09	1997.12		1589	F300/F310	G			
GRAN MOVE	1996.08	1998		1499	G303	G			
	1998.07			1589	G301	G	AKE/SUM		
MINIVAN	1978.09	1986.05		547	S65	G			
	1983.12	1989.04		993	S75, S76, S85, S86	G			
	1992.12	1994.07		993	S85	G	SUM		
	1994.08			993	S85	G	SUM		
MOVE	1995.08	1998.11		660	LS600S, LS610S	G		G1N019	
	1995.08	1998.11		660	LS600S, LS610S, 602S	G		G1N019	
	1995			847	L	G	AKE		
ROCKY	1984.04	1993.04		1998	F80, F85	G			
	1991.09			2237	F95, F98	G			
	1984.04	1988.12		2765	F70, F75	D			
	1987.09	1990.11		2765	F70, F71, F75, F76 T	D			
	1988.12	1989.10		2765	F70, F75	D			
	1989.11	1993.04		2765	F70, F75	D			
	1990.11	1993.04		2765	F70, 71, 75, 76, 77, 78 T	D			
	1993.05	1997.08		2765	F73, F78 TDIC	D	AKE		
SIRION	1998.04	2000.09		989	M100	G		G1N018	
	2000.09	2005.01		989	M1	G			
	2000.10	2005.01		1298	M101	G		G1N018	
TERIOS	1997.03	2000.05		1296	J100G	G	SUM	D1N013	
	2000.10	2001.12		1298	J102G, J122G	G		D1N014	
	2001.12			1298	J102G, J122G	G		D1N014	
YRV	2000.08	2005.08		989	M200	G		G1N018	
	2000.08	2005.08		1297	M201, M211	G		G1N018	



Brake Master Cylinder



Brake Wheel Cylinder Front

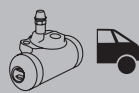

Brake Wheel Cylinder Rear Left

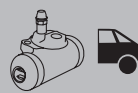

Brake Wheel Cylinder Rear Right

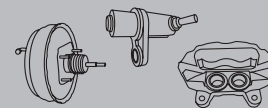

Other Parts

MD-012			
MD-008		A: AD-006L	A: AD-006R
		A: AD-006L	A: AD-006R
		A: AD-006L	A: AD-006R
		A: AD-006L	A: AD-006R
		A: AD-006L	A: AD-006R
		A: AD-006L	A: AD-006R
MD-008		A: AD-006L	A: AD-006R
MD-009		A: AD-006L	A: AD-006R
		A: AD-006L	A: AD-006R
MD-009			
MD-012			
		A: WCT-006	A: WCT-006
		A: WCT-006	A: WCT-006
MD-006		A: AD-004	A: AD-004
MD-006			
MD-006		A: AD-004	A: AD-004
MD-013 RHD: MD-014			
MD-003		A: AD-032L	A: AD-032R
MD-003		A: AD-032L	A: AD-032R
		A: AD-029L	A: AD-029R
		A: AD-029L	A: AD-029R
MD-019			
MD-019		A: AD-012L	A: AD-012R
MD-004		A: AD-031L	
MD-004			
MD-035		A: AD-027	A: AD-027
MD-003		A: AD-032L	A: AD-032R
MD-002			
MD-031		A: AD-032L	A: AD-032R
MD-003		A: AD-032L	A: AD-032R
MD-031		A: AD-032L	A: AD-032R
MD-031		A: AD-032L	A: AD-032R
MD-003		A: AD-032L	A: AD-032R
MD-002			
MD-033		A: AD-030	A: AD-030
MD-033		A: AD-030	A: AD-030
MD-033		A: AD-030	A: AD-030
MD-033		A: AD-031	A: AD-031
MD-033		A: AD-030	A: AD-030

APPLICATION LIST



CCM

Body Type



Brake Code



Brake Pads Front



Brake Pads Rear

**FIAT**

UNO	1985.05			1300	146A to chss 1044879, 149A7.000 to chss 1906296	G	LUC		G2N010
-----	---------	--	--	------	---	---	-----	--	--------

**FORD**

COURIER	1996.04	1999.10		1388	J5, J3	G			
ESCORT 86	1988.07	1990.07	JBA	1297	AVF	G			
	1986.02	1990.07	JBB/JLA/ JLB	1297	AVF/AWF	G			
	1986.02	1990.07	F6B/F6D/ FUC	1392	AVF	G			
ESCORT 91	1990.07	1994.12	JBD	1299	AVL	G			
	1990.07	1994.12	F6F/G	1391	AVL	G			
	1990.07	1994.12	RTH	1753	AVL	D			
ESCORT EXPRESS	1990.06	1995.01	RTH	1753	AVL	D			
ESCORT III	1983.08	1985.12	GSE	1117	AWA	G			
	1981.03	1985.12	JPA	1296	GAA/AVA/AWA/ALD	G			
	1980.08	1990.07		1300	OHV/HCS/CVH 51Kw	G	ATE		
ESCORT IV	1985.12	1990.07	GSG	1117	GAF, AWF, ABFT	G			
	1985.12	1990.07	GSG	1117	OHV/HCS 37Kw	G	ATE		
	1986.11	1988.07		1296	GAF, AWF, ABFT	G			
	1988.07	1990.10	JBA	1297	GAF, AWF, ABFT	G			
	1986.01	1990.08	JBB/JLA/ JLB	1297	OHV/HCS 44Kw	G	ATE		
	1986.01	1990.07	F6B/D/ FUC	1392	GAF, AWF, ABFT, AVF	G			
	1985.10	1990.10	FUA	1392	GAF, AWF, ABFT	G			
	1986.01	1990.07	FUA	1392	GAF, AWF, ABFT, AVF, ALF	G			
	1986.01	1990.07	FUC/ F6B/F6D/ FUA	1392	OHV/CVH 54/55Kw	G	ATE		
	1986.01	1988.12	LP2	1597	GAF, AWF, ABFT	G			
	1986.01	1990.05	L4B, LR2, LRB	1598	GAF, AWF, ABFT, ALF, AVF	G			
	1989.04	1990.07	LUG	1598	GAF, AWF, ABFT	G			
	1986.01	1989.01	LTC	1608	GAF/AWF/ABFT/AVF	D			
1989.01	1990.07	RTA/B	1753	GAF, AWF, ABFT, AVF	D				
ESCORT V	1991.09	1992.09	J4B/J6B	1299	GAL/AVL	G			
	1990.07	1992.09	F6F/G	1392	GAL, ALL	G			
	1994.01	1995.01	L1H, L1E, RDA	1597	GAL, ALL	G			
	1990.07	1992.12	LJF, LUJ, LUK	1598	GAL, ALL, AVL	G			
	1992.02	1992.12	RDA	1796	GAL, ALL, AVL	G			
ESCORT VI	1992.09	1995.01	J4B/J6B	1299	GAL/AVL	G			
	1992.09	1995.01	F4B, FUH, F6F/G	1391	GAL, AAL, ABL, AFL, ANL	G			





CCM

Body Type



Brake Code



Brake Pads Front



Brake Pads Rear

# FORD

APPLICATION LIST

ESCORT VI	1992.09	1995.01	L1E	1597	GAL	G			
	1994.01	1995.01	L1H	1597	GAL	G			
	1993.08	1995.01	RDA	1796	4WD	G	ATE		
	1993.08	1995.01	RDA	1796	GAL	G			
ESCORT VII	1995.01	1998.10	F4B	1391	GAL, AAL, ABL, AFL, ANL	G			
	1995.01	1998.10		1597	ZETEC	G	ATE		
	1995.02	1998.10	L1E	1597	GAL, AAL, ABL 4WD	G	ATE		
	1995.01	1996.12	RTE/F/H	1753	GAL, AAL, ABL, AFL	D	BDX		
FIESTA	2001.11		FYJA	1596	JH_/JD_	G			
FIESTA 96	1995.08	2002.03	DHA	1242		G	ATE		
	1995.08	2001.02	J4C	1299		G	ATE		
	1999.09	2002.03	J4C	1299		G	ATE		
	1995.08	2001.02	FHA	1388		G	ATE		
	1999.09	2002.03	FHA	1388		G	ATE		
	1995.08	2002.03	RTJ/K	1753		D	ATE		
FIESTA V	2001.11	2005.08	F6JA/B	1399	JH_/JD_ Tdci	D			
FUSION	2002.08	2005.08	F6JA/B	1399	JU Tdci	D	+ABS		
	2002.08		FYJA	1596	JU_	G			
ORION	1989.01	1990.07	RTA/B	1753	AFF	D			
ORION I	1983.07	1986.03	JPA	1296	AFD	G			
	1983.07	1986.03	LP1/A, LR1/A	1597	AFD	G			
ORION II	1985.12	1990.07	JBB/JLA/JLB	1297	AFF	G			
	1987.02	1990.07	F6A/F6B	1392	AFF	G			
	1985.12	1990.07	FUA	1392	AFF	G			
	1986.01	1990.07	FUC	1392	AFF	G			
	1986.03	1990.07	L4B	1597	AFF	G			
	1989.08	1990.07	LJB	1597	AFF	G			
	1986.03	1990.07	LRB	1597	AFF	G			
	1985.12	1990.07	LUC, LRB, LAB	1597	AFF	G			
	1985.12	1989.01	LTC	1608	AFF	D			
1989.01	1990.07	RTA/B	1753	AFF	D				
ORION III	1990.07	1993.12	J4B/J6B	1299	GAL	D			
	1990.07	1993.12	F6F/G	1391	GAL	G			
	1992.07	1993.07	L1E/K	1597	GAL	G			
	1990.07	1992.09	LJF	1598	GAL	G			
	1992.02	1993.12	RDA	1796	GAL	G			
PROBE	1993	1998	FS	1991	T20A16V	G	SUM	E1N026	E2N027
	1992.09	1998	KL	2497	T20BIZVTB V6	G	SUM	E1N026	E2N027

# HONDA

ACCORD	1983.06	1985.06	EY	1598	AC	G	AKE	C1N013	
	1985.06	1989.07	18A	1829	CA1-100/06/10/20, CA2-100/06/10/20	G	AKE	C1N033	
	1989.08	1993.10	F18A	1849	CB1-100, CB2-100	G	AKE	C1N034	C2N015







CCM

Body Type



Brake Code



Brake Pads Front



Brake Pads Rear

# HONDA

APPLICATION LIST

ACCORD	1996.05	1998.01	F18Z1	1850	CE7	G	AKE	C1N023	C2N015
	1985.01	1989.10	A20A	1955	CA5, CA6 series	G	AKE	C1N033	
	1988.04	1990.04	A20A3	1955	CA5, CA6 series	G	AKE	C1N033	
	1985.06	1989.10	B20A2	1958	CA3-100/06/20/30, CA5	G	AKE	C1N033	
	1989.01	1990	B20A2	1958	CA5	G	AKE	C1N033	
	1988	1988	B20A8	1958	CA3-100/06/20/30, CA5	G	AKE	C1N033	
	1989	1989	B20A8	1958	CA3-100/06/20/30, CA5	G	AKE	C1N033	
	1996.05	1998.10	20T2N	1994	CF1 TDI	D	LUC/AKE-ABS	C1N023	
	1989.08	1992	F20A2/4	1997	CB3-100, CB4-100	G	AKE		C2N015
	1993.01	1996	F20Z1	1997	CC7	G	LUC/AKE-ABS		
	1996.05	1998.01	F20Z1	1997	CE8	G	AKE	C1N023	C2N015
	2002.10		K20A6	1998	CL7	G		C1N026	C2N015
	1992.01	1994.02	F22A	2156	CB7	G			C2N015
	1990	1992	F22A3	2156	CB7, CB9	G	AKE		C2N015
	1996.05	1997.11	H22A2	2156	CE9	G	AKE	C1N023	C2N015
	1993.01	1996.02	H23A3	2259	CC7	G	AKE/AKE	C1N018	
	2003.07	2004.10	K24A3	2354	CL9	G		C1N026	C2N015
2008.07		K24Z3	2354	CU2/CW2	G		C1N026	C2N015	
ACCORD AERODECK	1985.01	1989	A20A3	1955	CA5, CA6 series	G			
	1994.06	1998.02	F20B3	1997	CE2	G	AKE	C1N023	C2N015
	1991.01	1994.07	F20Z3	1997	CC9	G	LUC/AKE	C1N023	
	1990	1994.07	F22A6/7/8	2156	CB8, CB9	G	AKE	C1N034	C2N015
	1994.06	1997.10	F22B5	2156	CE1	G	AKE	C1N034	C2N015
ACCORD COUPE	1992.01	1993.09	F20A7	1997	CC1	G			
	1994.06	1997.12	F20B3	1997	CD9	G	AKE	C1N018	C2N015
	1994.06	1997.12	F22B5	2156	CD7	G	AKE	C1N034	C2N015
	1998.01		J30A1	2997	CG2	G	AKE	C1N018	C2N015
ACCORD type R	1999.01	2002.12	H22A7	2157	CF VTEC	G	AKE/LUC	C1N018	
CIVIC	1972.07	1975.07	EB1	1169	SB1	G			
	1983.09	1987.10	ZA2	1187	AF, AL	G	AKE		
	1983.09	1987.10	EV	1342	AG, AJ	G	SUM		
	1988.01	1991.12	D13B	1343	EC8	G	AKE		
	1991.09	1995.08	D13B	1343	EG3, EG7	G	AKE		
	2001.02			1396	EU, EP fr chss nr 1000001 to 2000000	G			C2N015
	2001.02			1396	EU, EP fr chss nr 2000001	G			C2N015
	2001.02			1396	EU, EP to chss nr 1000000	G			C2N015
	1987.10	1988.12	D14	1396	EC9 to chss nr 100000	G	SUM		C2N022
	1987.10	1988.12	D14	1396	ED2 to chss nr 100000	G	SUM		C2N022
	1989.01	1991	D14	1396	EC9 chss nr 100001 to 200000	G	SUM		C2N022



Brake Master Cylinder

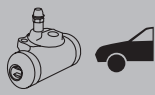

Brake Wheel Cylinder Front

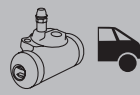

Brake Wheel Cylinder Rear Left

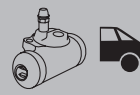

Brake Wheel Cylinder Rear Right

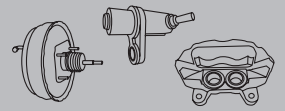

Other Parts

MH-016				
MH-001				
MH-002		A: AH-004	A: AH-004	
MH-002		A: AH-004	A: AH-004	
MH-002		A: AH-004	A: AH-004	
MH-002		A: AH-004	A: AH-004	
MH-044		A: AH-003L	A: AH-003R	
MH-044				
MH-045		A: AH-003L	A: AH-003R	
MH-044				
MH-018		A: AH-004	A: AH-004	
MH-045				
MH-021				
MH-020				
MH-020				
MH-021				
MH-021				
MH-020				
			A: AH-016	
MH-001		A: AH-002L	A: AH-002R	
MH-001		A: AH-002L	A: AH-002R	
MH-003		A: AH-002L	A: AH-002R	
MH-003		A: AH-003L	A: AH-003R	
MH-032		A: AH-003L	A: AH-003R	
MH-032		A: AH-003L	A: AH-003R	
MH-032		A: AH-003L	A: AH-003R	
MH-003		A: AH-002L	A: AH-002R	
MH-003		A: AH-002L	A: AH-002R	
MH-003		A: AH-002L	A: AH-002R	

APPLICATION LIST



CCM

Body Type



Brake Code

Brake Pads  
FrontBrake Pads  
Rear

# HONDA

APPLICATION LIST

CIVIC	1989.01	1991	D14	1396	ED2 chss nr 100001 to 200000	G	SUM		
	1991	1995	D14	1396	EC9 fr chss nr 200001	G	SUM		
	1997.12		D14A2	1396	EJ9 3 doors	G	SUM	C1N016	
	1995.11	1997.12	D14A3/ D14A4	1396	EJ9 3 doors	G	SUM		
	1997.12	2001.03	D14A3/ D14A4	1396	EJ9 3 doors	G	SUM	C1N016	
	1983.09	1987.10	EW	1488	AK, AH, AF100/110, AK	G	SUM		
	1987.06	1988.08	D15	1493	EF4-100 4WD	G			C2N022
	1988.08	1991	D15	1493	EF4-110 4WD	G			C2N022
	1987.06	1988.08	D15B	1493	EF2-100/300/500	G		C1N004	C2N022
	1988.08	1991.08	D15B	1493	EF2-110/310/510	G		C1N004	C2N022
	1989.08	1991.08	D15B	1493	EF2-120/130/320 /520/530 TC	G			C2N022
	1991.09	1995.12	D15B2	1493	EG4, EG8	G	SUM	C1N016	C2N022
	1991.09	1995.12	D15Z1	1493	EG4 VTEC	G	SUM	C1N020	
	1995.03	1996.12	D15Z3	1493	MA9 5 doors VTEC-E	G	LUC		C2N022
	1996.01	2001	D15Z6	1493	EK3 VTEC	G	SUM	C1N020	
	2000.09		D15B	1500	ES2	G		C1N016	
	1989.10	1991	B16A1	1590	ED/EE 110 Kw VTEC	G	AKE		C2N022
	1987.11	1991.11	D16A6	1590	ED	G	AKE		C2N022
	2001.02	2001.09	D16V1	1590	EU, EP	G			C2N015
	1995.03	1997.01	D16Y2/3	1590	MB1	G	LUC/AKE		C2N022
	1996.01		D16Y5	1590	EK1 VTEC	G			C2N022
	1988.01	1991.12	D16Z2/6	1590	ED7	G	AKE		C2N022
	1991.11	1995	D16Z6	1590	EG5 Esi VTEC	G	SUM	C1N016	C2N022
	1991.11	1995.12	D16Z6	1590	EH9 Esi VTEC	G	SUM	C1N020	C2N022
	1987.10	1988.08	ZC	1590	EF3, EF5 EFI	G			C2N022
	1988.08	1989.08	ZC	1590	EF3, EF5 EFI	G			C2N022
	1988.08	1989.08	ZC	1590	EF5-110 4WD	G			C2N022
	1989.08	1991.08	ZC	1590	EF3, EF5 EFI	G			C2N022
	1989.08	1991.08	ZC	1590	EF5-120/130 4WD	G			C2N022
	1991.11	1995.09	B16A2	1595	EG6, EG9VTi VTEC	G	SUM/AKE	C1N016	C2N022
	1995.08	2000.09	B16A2	1595	EK4 VTEC	G	LUC/AKE	C1N016	C2N022
	2002.01		4EE20	1686	EU, EP	D		C1N016	C2N015
1997.01		D18C4	1797	MB6 5 doors VTI	G	AKE/AKE		C2N015	
1997.01		20T2N	1994	MB7 5 doors T	D	LUC		C2N010	
CIVIC COUPE	1994.04	1995.12	D15B	1493	EJ2	G	SUM	C1N020	
	1996.01	1997.01	D16Y7	1590	EJ6 -LS Type	G	SUM	C1N020	
	1997.01	1997.12	D16Y7	1590	EJ6 -LS Type	G	SUM	C1N016	
	1996.01	2000	D16Y8	1590	EJ8 -SR Type VTEC	G	SUM	C1N016	
CIVIC CRX	1984.01	1987.05	EW3	1488	AF120, AF130	G	SUM		
	1987.10	1988.12	D16	1590	ED9	G	AKE/AKE		
	1988.12	1989.12	D16	1590	ED9	G	AKE/AKE		
	1990.01	1992.05	D16	1590	ED9	G	AKE/AKE		
	1992.06	1998.12	D16Z6	1590	EH6 Esi VTEC	G	SUM	C1N016	C2N022



Brake Master Cylinder

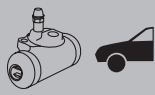

Brake Wheel Cylinder Front

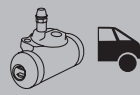

Brake Wheel Cylinder Rear Left

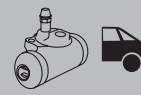

Brake Wheel Cylinder Rear Right

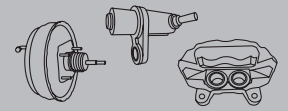

Other Parts

MH-003		A: AH-002L	A: AH-002R	
MH-003		A: AH-002L	A: AH-002R	
MH-041		A: AH-003L	A: AH-003R	
MH-041		A: AH-003L	A: AH-003R	
MH-001		A: AH-002L	A: AH-002R	
MH-003		A: AH-003L	A: AH-003R	
MH-003		A: AH-003L	A: AH-003R	
MH-003		A: AH-003L	A: AH-003R	
MH-032		A: AH-003L	A: AH-003R	
MH-012				
MH-043		A: AH-002L	A: AH-002R	
MH-032		A: AH-003L	A: AH-003R	
MH-043		A: AH-002L	A: AH-002R	
MH-003				
MH-032				
MH-003		A: AN-020	A: AN-020	
		A: AH-015L	A: AH-015R	
MH-003		A: AH-003L	A: AH-003R	
MH-041		A: AH-003L	A: AH-003R	
MH-041		A: AH-003L	A: AH-003R	
MH-041		A: AH-003L	A: AH-003R	
MH-001		A: AH-002L	A: AH-002R	
MH-004				
MH-004				
MH-004				
MH-004		A: AH-003L	A: AH-003R	

APPLICATION LIST





CCM

Body Type



Brake Code



Brake Pads Front



Brake Pads Rear

# HONDA

APPLICATION LIST

CIVIC CRX	1984.11	1987.10	ZC1	1590	AS	G	AKE/AKE		
	1990.06	1992	B16A1	1595	EE8 VTEC	G			
	1991.11	1998.12	B16A2	1595	EG2 VTI VTEC	G	SUM/AKE+ABS	C1N016	C2N022
CIVIC SHUTTLE	1984.01	1987.05	EW	1488	AK/AN series FWD	G	AKE		
	1984.10	1987.10	EW	1488	AR 4WD	G	AKE		
	1995.06	1997.12	F22B	2156	RA1	G	AKE/AKE	C1N018	
	1998.01	2002.06	F23A	2254	RA3	G	AKE/AKE	C1N018	
CIVIC Type R	2000	2004	K20A	1998	EP3	G			C2N015
CONCERTO	1989.01	1996.12	D14A	1396	HW	G	LUC/AKE		C2N022
	1991.08	1996.12	D15B	1493	MA1, HW 16V	G	LUC/AKE		C2N022
	1988.05	1996.12	D16..	1590	MA2, MA3, HW	G	LUC		
	1990.01	1996.12	D16..	1590	MA2, MA3	G	LUC/AKE		C2N022
	1989.01	1996.12	10CV2L	1769	HW	D	LUC/AKE		C2N022
CR-V	1995.10	1998.12	B20B	1973	RD1	G	AKE	C1N018	
HR-V	1998.09		D16A	1590	GH2	G	AKE	C1N018	
INTEGRA	1985.02	1988.12	D15A1/EW	1488	DA4, AV	G	AKE		
	1986.03	1988.12	D16A2	1590	DA1	G	AKE/AKE	C1N033	
INTEGRA TYPE R	1995.10	1998.01	B18C	1797	DC2	G	AKE/AKE	C1N024	C2N022
	1998.01	2000.09	B18C	1797	DC2	G		C1N018	C2N015
JAZZ	1982.07	1986.10	ER	1231	AA, VF fr. 13000001	G			
	2002.03	2005.12	L12A1	1243	GD	G			
	2002.03	2004.12	L13A1	1339	GD	G			
LEGEND	1987.02	1990.12	C27A	2675	KA3, KA4	G	AKE/AKE	C1N013	
	1991.08	1995.12	C32A	3206	KA7 SDN, KA8 CPE	G	AKE	C1N018	C2N021
	1996.01		C35A	3474	KA9 (EUR)	G		C1N026	C2N021
	1996.01		C35A	3474	KA9 (JPN)	G	AKE/AKE	C1N018	C2N021
LOGO	1300	2002.03	D13B	1343	GA3	G		C1N020	
NSX	1990.07	2005.09	C30A	2977	NA1 V6	G	AKE/AKE	C1N018	
ODYSSEY	2000	2004	F23A	2254	RA6, 7	G		C1N026	C2N021
PRELUDE	1978.11	1982.01	EP/EL	1602	SN	G			
	1982.01	1982.10	EP/EL	1602	SN	G			
	1986.01	1987.12	ET	1829	AB5	G	AKE	C1N013	
	1986.05	1987.03	B20A	1958	BA1/2	G	AKE/NIC		
	1987.04	1987.12	B20A3/4/5	1958	BA4	G	AKE/NIC		
	1989.09	1991	B20A3/4/5/9	1958	BA4/5	G	AKE/AKE		C2N022
	1988	1989.09	B20A3/5	1958	BA4/5	G	AKE/AKE		C2N022
	1987.01	1992.01	B20A	1986	BA	G			C2N022
	1991	1996.09	F20A4	1997	BB3 fr. chss nr 2003351	G	LUC/AKE	C1N013	C2N015
	1991	1996.09	F20A4	1997	BB3 to chss nr 2003350	G	AKE	C1N023	C2N015
	1996.10	2000.10	F20A4	1997	BB9	G	LUC/NIS	C1N013	C2N015
	1993.02	1997	H22A2	2156	BB1	G	AKE/AKE	C1N018	C2N015
	1997.01	2000.08	H22A5	2156	BB8	G	AKE	C1N018	C2N015
1992.04	1997	H23A2	2259	BA2, BB2	G	AKE/AKE	C1N018	C2N015	
QUINTET	1980.01	1981.08	EP/EL	1602	SU	G	SUM		



Brake Master Cylinder

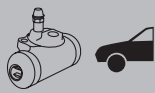

Brake Wheel Cylinder Front

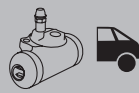

Brake Wheel Cylinder Rear Left

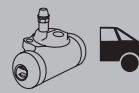

Brake Wheel Cylinder Rear Right

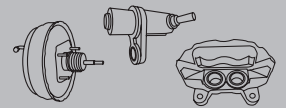

Other Parts

		A: AH-002L	A: AH-002R	
MH-010				
MH-004		A: AH-003L	A: AH-003R	
MH-001		A: AH-002L	A: AH-002R	
MH-001		A: AH-002L	A: AH-002R	
MH-021				
MH-012		A: AH-019L	A: AH-019R	
MH-012		A: AH-019L	A: AH-019R	
MH-012		A: AH-019L	A: AH-019R	
MH-037				
MH-037		A: AH-003L	A: AH-003R	
		A: AH-002L	A: AH-002R	
MH-040		A: AH-001L	A: AH-001R	
		A: AH-017	A: AH-017	
		A: AH-017	A: AH-017	
MH-029				
MH-046				
MH-046				
MH-046				
		A: AH-018	A: AH-018	
MH-005		A: AH-005L	A: AH-005R	
MH-005		A: AH-005L	A: AH-005R	
MH-006				
MH-022				
MH-043				
MH-043				
MH-043				
MH-030				
MH-030				
MH-042				
MH-030				
MH-042				
MH-030				
MH-005		A: AH-005L	A: AH-005R	

APPLICATION LIST



CCM

Body Type



Brake Code



Brake Pads Front



Brake Pads Rear

# HONDA

QUINTET	1981.09	1985.02	EP/EL	1602	SU fr E/G nr 1800001	G			
	1981.09		EP/EL	1602	SU to E/G nr 1800000	G	SUM		
S2000	1999.08		F20C2	1996	AP11	G			C2N015
SHUTTLE	1994.10	1998.02	F22	2156	RA	G			
STREAM	2001.01		D17A	1668	RN1/2	G	SUM/NIS	C1N016	
	2001.01		K20A	1998	RN3/4	G	SUM/NIS	C1N030	C2N021

# HYUNDAI

ACCENT	1999.06	2001.10		1341		G	AKE		
	2001.11	2003.10		1341		G	AKE		
	2003.10			1341	LC	G	AKE		
	1999	2001.10	D3EA	1493		D			
	2001.11	2003.10	D3EA	1493		D	AKE		
	2003.10		D3EA	1493	LC	D	AKE		
ATOS	1999		G4EB/C	1495		G	AKE		
	1997.09	2003.07		800		G	MAN		
ATOS PRIME	1997.11	2002.03	G4AC	998	AC	G	MAN		
	1998	2008	G4HC/E	998		G	MAN		
	2003	2008	G4HD	1086	MX	G			
BUS	2005	2008	G4HG	1086	12V	G			
	1988.04	1997	D4AF	3298	CHORUS	D			
COUPE	2002			1599		G			
	1996.04	2002	4G61	1599	RD	G	SUM Opt -ABS		
	1996.04	2002	G4GF	1975	RD	G	SUM Opt -ABS		
ELANTRA	2002		G6BA	2656	GK27	G			
	2001			1599	XD	G			
	2003.05			1599	XD	G			
	2000.06	2003	G4BB	1795	XD 16V	G			
	2001		G4GC	1975	XD	G			
EXCEL/ACCENT	2001		D4EA	1991	XD TD CRDI	D			
	1989.08	1994.08	G4DG	1341	1300 I	G	AKE +ABS		
	1989.08	1994.08	G4DG	1341	VD2M	G	AKE +ABS		
	1994.10	2000.01	G4EH	1341	UA##L, UF##L	G	AKE +ABS		
	1989.10	1994.10	G4DJ	1468	VA3J MPI	G	-ABS		
	1989.10	1994.10	G4DJ	1468	VF2J	G	+ABS		
	1989.10	1994.10	G4DJ/G15B	1468	VA3J MPI	G	+ABS		
	1994.07	1997.07	G4EK	1495	UA##N, UF##N	G	AKE +ABS		
	1997.08	2003.01	G4EK	1495	UA##N, UF##N	G	AKE +ABS		
	1994.07	1997.07	G4FK	1495	DN, FN 16V	G	AKE +ABS		
GETZ	1997.08	2003.01	G4FK	1495	DN, FN 16V	G	AKE +ABS		
	2002.09	2002.10	G4HD	1086	TB	G			
	2002.10		G4HD	1086	TB	G			



Brake Master Cylinder

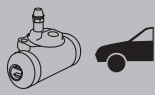

Brake Wheel Cylinder Front

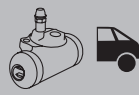

Brake Wheel Cylinder Rear Left

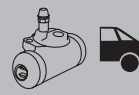

Brake Wheel Cylinder Rear Right

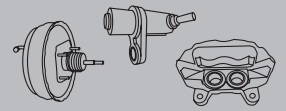

Other Parts

MH-005		A: AH-005L	A: AH-005R	
MH-005		A: AH-005L	A: AH-005R	
MH-021				

MY-018		A: AY-015L	A: AY-015R	
MY-018		A: AY-015L	A: AY-015R	
MY-018		A: AY-012L	A: AY-012R	
MY-018		A: AY-015L	A: AY-015R	
MY-018		A: AY-015L	A: AY-015R	
MY-018		A: AY-012L	A: AY-012R	
MY-018		A: AY-015L	A: AY-015R	
MY-013		A: AY-012L	A: AY-012R	
MY-013		A: AY-012L	A: AY-012R	
MY-013		A: AY-012L	A: AY-012R	
		A: AY-012L		
		A: AY-012L		
	LA: AY-013 RA: AY-013	A: AY-013	A: AY-013	
MY-023				
MY-019		A: AY-004L	A: AY-004R	
MY-019		A: AY-004L	A: AY-004R	
MY-023				
		A: AY-015L	A: AY-015R	
		A: WCT-009	A: WCT-012	
		A: WCT-009	A: AE-RO02R	
		A: AY-015L	A: AY-015R	
		A: AY-015L	A: AY-015R	
MY-016		A: AY-003L	A: AY-003R	
MY-016		A: AY-003L	A: AY-003R	
MY-011		A: AY-003L	A: AY-003R	
MY-011				
MY-016		A: AY-003L	A: AY-003R	
MY-016		A: AY-003L	A: AY-003R	
MY-011		A: AY-003L	A: AY-003R	
MY-017		A: AY-004L	A: AY-004R	
MY-011		A: AY-003L	A: AY-003R	
MY-017				
		A: AY-012L	A: AY-012R	
		A: AY-012L	A: AY-012R	

APPLICATION LIST



CCM

Body Type



Brake Code



Brake Pads Front



Brake Pads Rear

# HYUNDAI

APPLICATION LIST

GETZ	2002.09		G4EA	1341	TB13	G			
	2003.03		D3EA	1493	TB CRDi	D			
	2002.09	2002.12		1594	TB	G			
	2002.12			1594	TB	G			
H1	1998.05		G4CSS	2351	I	G	+ABS		
	1997.10	1999.05	TCI	2479	WWH7FP TD, TD 4WD	D			
	1999.05		TCI	2479	WWH7FP TD, TD 4WD	D			
H100	1993.07	1998.12	D4BA	2477	KM	D			
H100 GRACE	1986.12			2351	FI	G	LUC +ABS		
	1987		D4BA	2476		D	LUC +ABS		
			DABA	2476	T	D	LUC +ABS		
LANTRA	1990.10	1995.03	G4DJ	1468	JF2/JF3JEU	G	AKE		
	1990	1993.10	G4CR	1596	JF2/JF3REU	G	SUM		
	1993.10	1995.03	G4CR	1596	JF2/JF3REU	G	SUM/ AKE+ABS		
	1992.10	1995.03	G4CN	1836	JF3MEU	G	SUM/ AKE+ABS		
LANTRA II	1995.05		G4EK	1495		G			
	1995.05	1998.05	G4GR/ 4G61	1599	KF, KW	G	SUM/ AKE+ABS		
	1998.05		G4GR/ 4G61	1599	KF, KW	G	SUM/ AKE+ABS		
	1995.05	2000	G4GM	1795	XD18	G	SUM		
	1997.09		XUD9	1905		D	MAN+ABS		
MATRIX	2000.07	2001.10	D3EA	1493	FC CRDi	D	MAN		
	2001.11	2003	D3EA	1493	FC CRDi	D	MAN		
	2001		G4ED-G	1598	FC	G	MAN		
	2001.06		G4GB-G	1795	FC	G	MAN		
PONY	1978.01	1979.03	4G42	1238		G			
	1979.04	1983.07	4G42	1238	RA	G	SUM		
	1983.07	1986.09	4G42	1238	RA	G	SUM		
	1986.01	1991	4G13	1298	HF	G	SUM		
	1978.11	1979.03	4G33	1439		G			
	1979.03	1983.07	4G33	1439	RA	G	SUM		
	1983.07	1986	4G33	1439	RA	G	SUM		
	1986.01	1992	4G15	1468	HJ	G	SUM		
S COUPE	1990.01	1992.06	G4DJ	1468	VE2JEU	G	AKE		
	1990.01	1992.06	G4DJ	1468	VE2JEU Opt	G	AKE/Opt		
	1990.01	1992.06	G4DJ	1468	VE3JEU	G	AKE		
	1990.01	1992.06	G4DJ	1468	VE3JEU Opt	G	AKE/Opt		
	1992.07	1995.05	G4EK	1468	VE/UE	G	AKE		
	1992.07	1995.05	G4EKT	1468	VE2/3NEU T	G	AKE		
SANTA FE	2000.08	2003.04	D4EA	1991	SM CRDi 2X4	D			
	2001.04	2003.05	D4EA	1991	SM CRDi 4X4	D			
	2003.05	2006	D4EA	1991	SM CRDi 4X4	D			
	2001	2006	G4BP	1997	SM	G			
	2000.08	2006	G4JS	2351	SM24	G			
	2000.08	2006	G6BA	2656	SM27 V6	G			





Brake Master Cylinder



Brake Wheel Cylinder Front

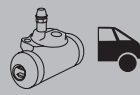

Brake Wheel Cylinder Rear Left

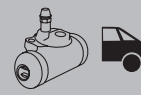

Brake Wheel Cylinder Rear Right

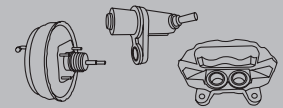

Other Parts

		A: AY-012L	A: AY-012R	
		A: AY-012L	A: AY-012R	
		A: AY-012L	A: AY-012R	
		A: AY-012L	A: AY-012R	
		A: AY-014L	A: AY-014R	
		A: AY-014L	A: AY-014R	
		A: AY-014L	A: AY-014R	
		A: AY-020L	A: AY-020R	
		A: AY-011L	A: AY-011R	
		A: AY-011L	A: AY-011R	
		A: AY-011L	A: AY-011R	
MY-001		A: AY-004L	A: AY-004R	
MY-001		A: AY-004L	A: AY-004R	
MY-001		A: AY-004L	A: AY-004R	
MY-002		A: AY-004L	A: AY-004R	
		A: AY-004L	A: AY-004R	
		A: AY-004L	A: AY-004R	
		A: AY-004L	A: AY-004R	
		A: AY-004L	A: AY-004R	
		A: AY-004L	A: AY-004R	
MY-014		A: AY-015L	A: AY-015R	
MY-014		A: AY-015L	A: AY-015R	
MY-014		A: AY-015L	A: AY-015R	
MY-014		A: AY-015L	A: AY-015R	
		A: AY-003L	A: AY-003R	
		A: AY-003L	A: AY-003R	
		A: AY-003L	A: AY-003R	
		A: AY-003L	A: AY-003R	
		A: AY-003L	A: AY-003R	
		A: AY-003L	A: AY-003R	
		A: AY-003L	A: AY-003R	
MY-004		A: AY-001	A: AY-001	
MY-004		A: AY-001	A: AY-001	
MY-004		A: AY-001	A: AY-001	
MY-004		A: AY-001	A: AY-001	
MY-001		A: AY-001	A: AY-001	
MY-001		A: AY-001	A: AY-001	
		A: AY-017L	A: AY-017R	
		A: AY-017L	A: AY-017R	
		A: AY-017L	A: AY-017R	
		A: AY-017L	A: AY-017R	
		A: AY-017L	A: AY-017R	
		A: AY-017L	A: AY-017R	

APPLICATION LIST



CCM

Body Type



Brake Code



Brake Pads Front



Brake Pads Rear

# HYUNDAI

SANTAMO	1995.02	1999.12	G4CP	1997	2WD	G	SUM/AKE+ABS		
	1995.02	1999.12	G4CP	1997	4WD	G	SUM		
SONATA	1988.01	1989.12	G4CM	1795	AFD-/-BF2/3DEU	G	SUM		
	1990.01	1994	G4CM	1795	AFD-/-BF2/3DEU	G	SUM		
	1994	1996.12	G4CM	1795	AFD-/-BF2/3DEU	G	SUM +ABS		
	1993.05	1994.11		1997		G	SUM+ABS		
	1998.04			1997		G	SUM-ABS		
	1989	1994	G4CD	1997	AFF-/-BF2/3FEU	G	SUM+ABS		
	1994	1996.12	G4CD	1997	AFF-/-BF2/3FEU	G	SUM+ABS		
	1991.03	1994	G4CP	1997	AFS/BFS 2,0 i 16V	G	SUM+ABS		
	1994	1996.12	G4CP	1997	AFS/BFS 2,0 i 16V	G	SUM+ABS		
	1996.09	1998.05	G4ED	1997	F2/F3	G	+ABS		
	1998.04	2001	G4EP	1997		G	SUM+ABS		
	1998.04	2001	G4JP-G	1997	EF	G	MAN+ABS		
	1998.03	1998.11		2351	EF 16V	G	+ABS		
	1998.11	2001.10		2351	EF 16V	G	+ABS		
	1989	1992.10	G4CSS	2351	AFS-/-BF2/3SEU	G	SUM		
	1998.05	2000.06	G6DV	2493	EN41E	G	MAN+ABS		
2000.06	2001.10	G6DV	2493	EN41E	G	MAN+ABS			
1998.05	2001.10		2656		G	+ABS			
2001.10		G6BA-G	2656	EF4	G				
STELLAR	1983		4G33	1439	TK	G	ATE		
	1983	1991	4G32	1597	MTE	G	AKE		
	1986.	1989	4G52	1995	TK	G	AKE		
TERRACAN	2001.12		D4BH	2476	HP	D	+ABS		
	2001.12		J3	2902	HP CRDi 110 KW	D			
	2001.12		G6CU	3497	HP V6	G			
TRAJET	2001.04		D4EA	1991	FO	D	MAN		
	1999.09		G4JP-G	1997	F20	G	MAN		
	2000.09		G6BA	2656	F27 V6	G	MAN		
TUCSON	2004.08		G4GC	1975	JM 16V CVVT 2WD	G			
	2004.08		G4GC	1975	JM 16V CVVT 4WD	G			
	2004.08		D4EA	1991	JM Crdi 16V - 83Kw	D			
	2004.06		G6BAH	2656	JM V6 24V	G			
XG	1999.06		G6AV	2493	FU41C	G	MAN		
	2000.08		G6ATX	2972	FU41D	G	MAN		
	1998.12	2000.08	G6CT-G	2972	FU41D	G	MAN		

# INFINITI

FX35	2003.01		VQ35DE	3498	V6	G		B1N079	
FX45	2003.01		VK45DE	4495	V8	G		B1N079	



Brake Master Cylinder



Brake Wheel Cylinder Front

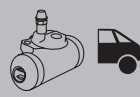

Brake Wheel Cylinder Rear Left

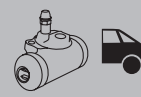

Brake Wheel Cylinder Rear Right

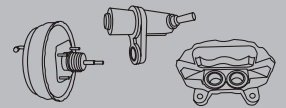

Other Parts

MY-034		A: AY-019L	A: AY-019R	
MY-034		A: AY-019L	A: AY-019R	
MY-027		A: AY-001	A: AY-001	
MY-027		A: AY-006L	A: AY-006R	
MY-007		A: AY-016	A: AY-016	
MY-027		A: AY-006L	A: AY-006R	
MY-029				
MY-027		A: AY-006L	A: AY-006R	
MY-007		A: AY-016	A: AY-016	
MY-027		A: AY-006L	A: AY-006R	
MY-007		A: AY-016	A: AY-016	
MY-007		A: AY-004L	A: AY-004R	
MY-030		A: AY-016	A: AY-016	
MY-030		A: AY-016	A: AY-016	
MY-030		A: AY-016	A: AY-016	
MY-030		A: AY-016	A: AY-016	
MY-027		A: AY-006L	A: AY-006R	
MY-030		A: AY-016	A: AY-016	
MY-030		A: AY-016	A: AY-016	
MY-030			A: AY-016	
MY-026				
MY-026				
MY-026				
MY-036		A: AY-018L	A: AY-018R	
MY-036		A: AY-018L	A: AY-018R	
MY-036		A: AY-018L	A: AY-018R	
MY-032		A: AY-017L	A: AY-017R	
MY-032		A: AY-017L	A: AY-017R	
MY-033		A: AY-017L	A: AY-017R	
MY-025				
MY-025				
MY-025				
MY-025				
MY-031				
MY-031				
MY-031				

APPLICATION LIST



CCM

Body Type



Brake Code



Brake Pads Front



Brake Pads Rear

## ISUZU

PICK-UP "KB"	1982.12	1987	C223	2238	KBD22/27 2WD	D			
	1982.12	1987	C223	2238	KBD42/47 4WD	D			
TROOPER	1984.01	1991	C223T	2238	UBS52 T	D			
	1984.01	1991.12	4ZD1	2254	UBS16	G			
	1987.08	1992	4ZE1	2559	UBS17 except UK		AKE/AKE		
	1987.08	1992.03	4JB1T	2771	UBS55 T	D	AKE/AKE		

## KIA

AVELLA	1994.03		B3	1324		G	SUM	E1N013	
	1995		B5	1498		G	SUM	E1N013	
MAGENTIS	2000		G4JP	1997	GD	G		B1N020	
	2000		G6BV	2493	GD V6	G		B1N020	
SPORTAGE	1994.08	2003	FE	1998	JA5525/JA5535	G			
	1993.07	1994.08	FEDI	1998	JA5525/JA5535	G			
	1996.06	1997.04	RF	1998	K00M T	D			

## LEXUS

GS300	1997	2000	2JZ-GE	2995	JZS160	G			
	2000		2JZ-GE	2995	JZS160	G			
	2005			2997	S19#	G			
	1998.01		2JZ	2997	JZS161	G		A1N056	A2N099
	1991.10	1997.12	2JZ-GE	2997	JZS147	G		A1N041	A2N084
GS430	2005		3UZ	4293	UZS190	G			A2N118
	2000		3UZ-FE	4293	JZS160	G	SUM/AKE	A1N056	A2N099
IS200	1999.01		1G-FE	1988	GXE10 V6	G		A1N056	A2N099
	2001.07		1G-FE	1988	GXE10 V6	G		A1N056	A2N099
IS220	2005.08		2AD-FHV	2231	ALE20, GSE20	D			
IS250	2005.08		4GR-FSE	2499	GSE20 V6	G			A2N118
IS300	2001.06		2JZ-GE	2997	GXE10	G		A1N019	
LS400	1990.01	1992.08	1UZ-FE	3969	UCF10	G	SUM	A1N041	A2N042
	1992.08	1994.10	1UZ-FE	3969	UCF10	G		A1N056	A2N059
	1994.11	1996.08	1UZ-FE	3969	UCF2#	G		A1N025	A2N058
	1996.08	1999.08	1UZ-FE	3969	UCF2#	G		A1N025	A2N058
	1996.08	1999.08	1UZ-FE	3969	UCF2# for Europe	G		A1N025	A2N058



Brake Master Cylinder

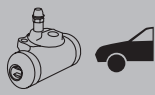

Brake Wheel Cylinder Front

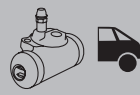

Brake Wheel Cylinder Rear Left

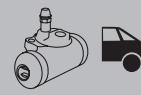

Brake Wheel Cylinder Rear Right

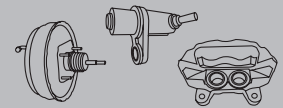

Other Parts

MG-004		A: AG-002LR	A: AG-002LR	
MG-004		A: AG-002LR	A: AG-002LR	
MG-005		A: AG-002LR	A: AG-002LR	
MG-004		A: AG-002LR	A: AG-002LR	
MG-018				
MG-018				

			A: AY-016	
			A: AY-016	
MK-003		A: AK-004	A: AK-004	
MK-003		A: AK-004	A: AK-004	
MK-003		A: AK-004	A: AK-004	

BMT-135				BC FL: A5L021 BC FR: A5R021 BC LR: A5L024 BC RR: A5R024
BMT-135				BC FL: A5L021 BC FR: A5R021 BC LR: A5L024 BC RR: A5R024
BMT-135				
BMT-135				
				BC FL: A5L021 BC FR: A5R021 BC LR: A5L024 BC RR: A5R024
				BC LR: A5L024 BC RR: A5R024
				ABS RRL: AST-014
				BC FL: A5L027 BC FR: A5R027
BMT-135				BC LR: A5L024 BC RR: A5L024 ABS RRL: AST-014
BMT-037				
BMT-037				
BMT-163				
BMT-163				
BMT-165				

APPLICATION LIST



CCM

Body Type



Brake Code

Brake Pads  
FrontBrake Pads  
Rear

# LEXUS

LS430	2000.07	2003.07	3UZ	4293	UCF31	G	SUM/SUM	A1N009	A2N010
	2003.07		3UZ	4293	UCF31	G		A1N009	A2N010
RX300	2003.02		1MZ	2995	MCU30	G		A1N110	A2N111
	1997.08		1M-Z	2995	MCU10/15	G	AKE	A1N097	A2N094
RX400h	2005.03		3MZ-FE	3311	MHU38W Hybrid	G		A1N110	A2N111
SC430	2001.04		3UZ	4292	UZZ40	G		A1N056	A2N099

# MAZDA

121	1987.11	1993.11	B1	1138	DA1	G	SUM		
	1987.11	1998.02	B3	1323	DA3	G	SUM		
	1990.11	1991.12	B3	1323	DB3	G	SUM	E1N014	
	1991.12	1996	B3	1323	DB3	G	SUM	E1N014	
	1995	1999.09	RTK	1753	JA, JB	D	ATE		
	1998.09	2004.03	RTK	1753	JA, JB	D	ATE		
2	2003.04		F6JA/B	1399	B2W	D			
	2003.02		B2W	1596	FYDD	G			
323	1980.05	1984.10	E1	1071	BD1011	G			
	1984.11	1986.11	E1	1071	BF1P	G	AKE		
	1978.08	1980.05	TC	1272	FA4TS, FA5TV, FA6TM/TS	G			
	1980.05	1984.10	E3	1296	BD1031	G	SUM		
	1984.11	1984.12	E3	1296	BF3P SDN, HBK	G	SUM	E1N014	
	1985.01	1986.11	E3	1296	BF3P SDN, HBK	G	SUM	E1N014	
	1985.12	1987.02	E3	1296	BF3V VAN	G	SUM	E1N014	E2N032
	1987.03	1989.09	E3	1296	BF3V/W VAN, WGN	G	SUM	E1N014	
	1986.11	1989.01	B3	1323	BFTP	G	SUM		
	1989.01	1995	B3	1323	BG3P, BG3S	G	SUM	E1N014	
	1998.08	2006.05	B33G	1323	BJ1	G	SUM	E1N003	
	1994	1998.09	B3	1324	BHA	G	SUM	E1N014	
	1994	1998.09	B3	1324	CBA 323-F 5doors	G	SUM	E1N014	
	1978.03	1981.11	UC	1415	FA4US, FA5US, FA6US SDN, HBK	G			
	1994	1998	Z5	1489	BHALP, BHA5S	G		E1N014	E2N029
	1986.11	1989	B5	1490	BF5P	G	AKE		
	1985.01	1986.12	E5	1490	BF5P SDN, HBK	G	AKE		
	1985.11	1987.02	E5	1490	BF5V VAN	G	AKE		E2N032
	1987.03	1989.09	E5	1490	BF5V/W VAN, WGN	G	AKE		
	1998.09	2006.05	ZL-DE	1498	BJ5W	G	SUM	E1N003	
	1989.06	1991.04	B6	1597	BG	G		E1N014	
	1991.04	1994.04	B6	1597	BG	G		E1N014	
	1985.09	1989	B6T	1597	BFMR T 4WD	G	AKE		
2002.11		ZM	1598	BJ	G		E1N026		
1994	1998.09	4EE1T	1686	BHA7R T	D		E1N016	E2N029	



Brake Master Cylinder

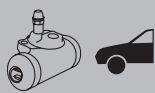

Brake Wheel Cylinder Front

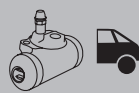

Brake Wheel Cylinder Rear Left

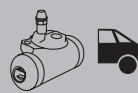

Brake Wheel Cylinder Rear Right

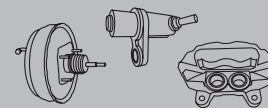

Other Parts

BMT-167				ABS RRL: AST-018 ABS RRR: AST-009
BMT-167				ABS RRL: AST-019 ABS RRR: AST-010
BMT-162				ABS RRL: AST-017 ABS RRR: AST-008
BMT-159				
				ABS RRL: AST-017 ABS RRR: AST-008
				ABS RRL: AST-012 ABS RRR: AST-004

MZ-044		A: WCT-048	A: WCT-048	
MZ-044		A: WCT-048	A: WCT-048	
MZ-088		A: WCT-048	A: WCT-048	
MZ-088		A: WCT-048	A: WCT-048	
		A: AZ-035	A: AZ-035	
		A: AZ-035	A: AZ-035	
		A: AZ-036	A: AZ-036	
		A: AZ-036	A: AZ-036	
MZ-003		A: AZ-005	A: AZ-005	
MZ-013		A: AZ-001	A: AZ-001	
MZ-012		A: AZ-014	A: AZ-014	
MZ-013		A: AZ-005	A: AZ-005	
MZ-013		A: AZ-001	A: AZ-001	
MZ-013		A: AZ-001	A: AZ-001	
MZ-013		A: AZ-001	A: AZ-001	
MZ-042		A: AZ-001	A: AZ-001	
MZ-007		A: AZ-002	A: AZ-002	
		A: AZ-037	A: AZ-037	
		A: AZ-024	A: AZ-024	
MZ-012		A: AZ-014	A: AZ-014	
MZ-042		A: AZ-001	A: AZ-001	
MZ-013		A: AZ-001	A: AZ-001	
MZ-013		A: AZ-001	A: AZ-001	
MZ-013		A: AZ-001	A: AZ-001	
		A: AZ-037	A: AZ-037	
MZ-007		A: AZ-002	A: AZ-002	
		A: AZ-001	A: AZ-001	
		A: AZ-002	A: AZ-002	

APPLICATION LIST



CCM

Body Type



Brake Code



Brake Pads Front



Brake Pads Rear

# MAZDA

APPLICATION LIST

323	1989.01	1994	1PN	1720	BG7P	D	SUM	E1N014	
	1985.09	1986.11	PN	1720	BF7P, BF7V	D	SUM		
	1986.12	1989	PN	1720	BF7P, BF7V	D	SUM		E2N032
	1987.05	1989.08	PN26/27	1720	BW12 WGN	D			
	1989.09	1991	PN54	1720	BW12 WGN	D			
	1998.05		B8/FP55	1840	BJ1	G	SUM		
	1989.01	1994.10	BP	1840	BG	G		E1N016	G2N010
	1990.01	1994.	BP	1840	BG8P, BG8S	G		E1N016	E2N032
	1994	1998.09	BP	1840	CBA	G	SUM/AKE		E2N030
	1989.06	1994.07	BP-T	1840	BG8Z T 4WD	G		E1N016	G2N010
	1994	1998.09	BP-ZE	1840	BHA8P	G		E1N016	E2N029
	1994	1998.09	BP-ZE	1840	CBA8P 323-F 5doors fr. chss nr 300001	G	SUM/AKE	E1N016	E2N029
	1994	1998.09	BP-ZE	1840	CBA8P 323-F 5doors to chss nr 300000	G	SUM/AKE	E1N016	E2N029
	1994	1999	KF-ZE	1995	CBAEP V6 323-F 5doors	G		E1N016	E2N029
	1996.11		RF	1998	BA1	D	SUM	E1N016	
1998.10	2001	RF	1998	BJ 52Kw	D		E1N026		
323F	1995.02		4EE1T	1686	TD	D			
	2000.10		FS	1991	BJ1	G			
	2001.02	2003.11	RF	1998	BJ	D			
626	1978.09	1982.08	NA	1586	CB2NS, CB2NA	G			
	1982.09	1987.09	F6	1587	GC6P	G	AKE		
	1987.03	1989.03	B6	1597	GD6P	G			
	1987.03	1992	F8	1789	GD8P, GD8S	G	SUM		
	1991.08	1997.06	FP	1840	GE	G	SUM/SUM		
	1997.04	2002.04	FP	1840	GF	G			
	1999.08	2002.04	FP	1840	GF1/GW LPG	G			
	1997.04	2002	FP33	1840	GF1#	G	SUM/AKE		E2N033
	1979.03	1980.09	MA	1970	CB2MS/H to chss nr 155000	G			
	1980.09	1982.09	MA	1970	CB2MS/H chss nr 155001 to 158361	G			
	1991.08	1997.07	FS	1991	GE	G	SUM/SUM		
	1997.04	1999.07	FS	1991	GF	G			
	1999.08	2002.04	FS	1991	GF/GW LPG	G			
	1997.04	2002	FSJ2/4	1991	GF1#	G	SUM/AKE		E2N033
	1982.09	1985.02	FE	1998	GCEP	G	AKE		
	1985.02	1987.03	FE	1998	GCEP	G	AKE/ AKE+ABS		
	1987.03	1991	FE	1998	GDEA, GDEP, GDES	G	SUM/SUM		
	1987.03	1992	FE	1998	GV station WGN	G	SUM/SUM		
	1987.08	1992.05	FE	1998	GDFE DOHC 16V	G			
	1989.08		FE	1998	GD74/6FE DOHC 16V 4WS HBK	G			
	1983.08	1985.07	RF	1998	GCFP	D	AKE		
	1985.08	1987.03	RF	1998	GCFP	D	AKE		
	1987.07	1989.03	RF	1998	GDFP	D	AKE	E1N035	





Brake Master Cylinder

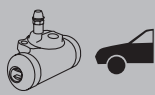

Brake Wheel Cylinder Front

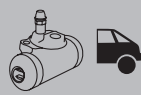

Brake Wheel Cylinder Rear Left

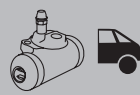

Brake Wheel Cylinder Rear Right

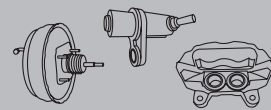

Other Parts

MZ-007		A: AZ-002	A: AZ-002	
MZ-013		A: AZ-001	A: AZ-001	
MZ-013		A: AZ-001	A: AZ-001	
		A: AZ-001	A: AZ-001	
		A: AZ-001	A: AZ-001	
		A: AZ-002	A: AZ-002	
MZ-007				
MZ-007		A: AZ-002	A: AZ-002	
MZ-007		A: AZ-002	A: AZ-002	
		A: AZ-002	A: AZ-002	
		A: AZ-002	A: AZ-002	
		A: AZ-002	A: AZ-002	
		A: AZ-037	A: AZ-037	
MZ-005		A: AZ-003	A: AZ-003	
MZ-004		A: AZ-003	A: AZ-003	
MZ-004		A: AZ-003	A: AZ-003	
MZ-006		A: AZ-002	A: AZ-002	
MZ-019		A: AZ-037	A: AZ-037	
MZ-019				
MZ-056				
MZ-005		A: AZ-003	A: AZ-003	
MZ-005		A: AZ-003	A: AZ-003	
MZ-055		A: AZ-037	A: AZ-037	
MZ-056		A: AZ-037	A: AZ-037	
MZ-056		A: AZ-037	A: AZ-037	
MZ-056		A: AZ-037	A: AZ-037	
MZ-004		A: AZ-002	A: AZ-002	
MZ-004		A: AZ-003	A: AZ-003	
MZ-006		A: AZ-002	A: AZ-002	
MZ-006				
MZ-006				
MZ-006		A: AZ-002	A: AZ-002	
MZ-004		A: AZ-003	A: AZ-003	
MZ-004		A: AZ-003	A: AZ-003	
MZ-018		A: AZ-002	A: AZ-002	

APPLICATION LIST



CCM

Body Type



Brake Code



Brake Pads Front



Brake Pads Rear

# MAZDA

APPLICATION LIST

626	1989.03	1992	RF	1998	GDFP	D	AKE	E1N035	
	1992.03	1997.07	RF	1998	GE comprex	D	SUM/SUM		
	1998.04	2002.04	RF2A	1998	GF1 TDVI	D	SUM/AKE		E2N033
	1987.09	1992	FZ	2184	GD	G			
929	1977.09	1981.09	MA	1970	LA4MS	G	AKE		
	1978.11	1981.10	MA	1970	LA4MV, LA7MV	G	AKE		
	1983.09	1986.07	FE	1998	HBEP, HBES	G	AKE		
B-series	1985.09	1996.03	FE	1998	UF1	G	SUM		
	1991.08	1999.01	F2L8	2184	UF2	G	SUM		
	1989.12	1996.03	R290/ R2TB	2184	UF2	D			
	1999.02		R5A2	2184	UN1	G			
	1996.04	1999.01	S531	2499	UF	G			
	2002.12		WLE7	2500	UN 62 KW	D			
	1989.11	1996.03	G6	2605	UF66M P-U & WGN	G	SUM		
DEMIO	1996.07	2002.07	B3-ME	1323	DW3W	G	SUM	E1N014	
E2000	1984	1988	FE18/ FEV4	1998	SR1	G			
E-serie	1983.05	1988	FE	1998	SR to chss nr 600000	G	AKE	E1N009	
	1988	1998.03	FE	1998	SR fr chss nr 600001	G	AKE	E1N009	
	1983.05	1987.08	R2	2184	SR2AV, SR2AT	D	AKE		
	1987.09	1988	R2	2184	SR2, SD2, SD29, SR29	D	AKE		
	1988.01	1988	R2	2184	SR2, SD29, SS28 4WD	D	AKE		
	1993.08		R2	2184	SD2AT, SE28T, SS28V/T	D	AKE	E1N009	
MPV	1999.05	2002-04	FS-G	1991	LWEW	G	SUM	E1N004	
	2002.03	2004.06	RF	1998	LW19	D	SUM	E1N021	
	2002.04	2003.08	L332	2261	LW3W	G	SUM	E1N004	E2N048
	1996.05	1999.08	WL-T	2499	LVL R T	D	SUM	E1N004	
	1996.05	1999.08	JE	2954	LVEW V6	G	SUM	E1N018	
MX-3	1991.05	1993.10	B6	1598	EC13	G	SUM/AKE	E1N016	
	1991.05	1994.01	K8	1845	EC8 V6	G	SUM/AKE	E1N016	G2N010
MX-5	2005.03			1798	NC	G		E1N054	
	2005.03			1999	NC	G		E1N054	
	2005		LF-VE	1999	NCEC MTM6	G		E1N054	
MX-5 MIATA	1989.06	1997.12	B6-Z	1597	NA6CE w/ ABS	G	SUM/ AKE+ABS	E1N015	G2N010
	1989.06	1997.12	B6-Z	1597	NA6CE w/o ABS	G	SUM	E1N015	G2N010
	1998.01	2005.10	B6-Z	1597	NB6C	G	SUM	E1N022	E2N030
	1998.01	2005.10	BP-ZE	1839	NB8C	G		E1N022	E2N030
	1989.06	1997.12	BP-ZE	1840	NA8C	G		E1N022	E2N030
MX-6	1991.07	1997.02	KF	1991	GEE	G	SUM/AKE	E1N026	
	1991.07	1997.02	KL	2497	GE5 V6	G	SUM	E1N026	
PREMACY	1999.07	2005.08	F5K2/3	1839	CP	G	SUM	E1N026	E2N033
	1999.08		F5K2/3	1839	FPE1	G		E1N026	
	1999.08	2001.07	RF3F	1998	CP	D	SUM	E1N026	E2N033
	1999.08	2005.08		2000		G		E1N026	



Brake Master Cylinder



Brake Wheel Cylinder Front

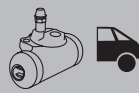

Brake Wheel Cylinder Rear Left

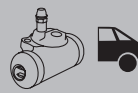

Brake Wheel Cylinder Rear Right

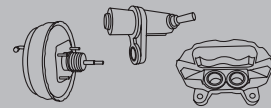

Other Parts

MZ-018		A: AZ-002	A: AZ-002	
MZ-019				
MZ-006		A: AZ-002	A: AZ-002	
MZ-022				
MZ-022				
MZ-022				
		A: AZ-006L	A: AZ-006R	
		A: AZ-023L	A: AZ-023R	
		A: AZ-006L	A: AZ-006R	
		A: AZ-034	A: AZ-034	
		A: AZ-034	A: AZ-034	
		A: AZ-034	A: AZ-034	
MZ-087		A: AZ-023L	A: AZ-023R	
MZ-002		A: AZ-007L	A: AZ-007R	
MZ-002		A: AZ-007L	A: AZ-007R	
MZ-002		A: AZ-007L	A: AZ-007R	
MZ-002		A: AZ-007L	A: AZ-007R	
MZ-002		A: AZ-007L	A: AZ-007R	
MZ-002		A: AZ-007L	A: AZ-007R	
		A: AZ-038	A: AZ-038	
		A: AZ-002	A: AZ-002	
		A: AZ-002	A: AZ-002	
MZ-048				
MM-045				

APPLICATION LIST



CCM

Body Type



Brake Code

Brake Pads  
FrontBrake Pads  
Rear

# MAZDA

RX-7	1983.09	1985.08	12A	1146	SA22C BR	G	AKE		E2N033
	1991		13B	1308	FD3S BR	G	SUM/AKE	E1N019	E2N033
	1985.09	1990	13BT	1308	FC3S, FC3C BR T	G	SUM/AKE	E1N011	E2N033
	1989.01	1990	13BT	1308	FC3S BR	G	SUM/AKE	E1N011	E2N033
RX-8	2003.05		13B-MSP	1308	SE3P	G		E1N006	
XEDOS 9	2001			2493	V6	G		E1N038	

# MITSUBISHI

3000GT	1990.09	1999.08	6G72	2972	Z16A V6 T 4WD	G			D2N012
CANTER	1985.10	1987.05	4DR5	2659	FE300/320	D		D1N039	
	1985.10	1991.04	4D30	3298	FE301/311/331/ 431	D		D1N039	
	1991.04	1993.10	4D30	3298	FE301/311/331/ 431	D		D1N038	
	1985.10	1991.04	4D32	3567	FE305/15/25/35/55, 425	D		D1N039	
CARISMA	1991.04	1993.10	4D32	3567	FE305/15/25/35/55, 425	D		D1N038	
	1995.03	1999.06	4G92	1597	DA1A	G	LUC/ AKE+ABS		
	1999.06	2006.06	4G92	1597	DA1A	G	LUC-ABS		
	1995.03	1997.07	4G93	1834	DA2 MSX 140HP	G	LUC/ AKE+ABS		
	1995.03	1997.08	4G93	1834	DA2A 115HP	G	LUC/ AKE+ABS		
COLT	1997.08	2006.06	4G93	1834	DA2 GDI 125HP	G	LUC-ABS		
	1996.09	1999	F8QT	1870	DA4A T	D	LUC-ABS		
	1984.01	1988.12	4G16	1198	C15A	G	SUM		
	1978.03	1983.09	G11B	1244	A151A, A155A	G	LUC		
	1987.09	1990.05	4G13	1298	C51A, C61A	G	SUM		
	1990.05	1991	4G13	1298	C51A, C61A	G	SUM	D1N013	
	1996.03	2000	4G13	1298	CJ1A	G	SUM	D1N013	
	1983.10	1987.08	G13B	1298	C11A, C11V	G	SUM		
	1991.12	1996.03	4G13	1299	CA1A	G	SUM	D1N013	D2N040
	1978.03	1983.09	G12B	1410	A152A, A156A	G	AKE		
	1981.12	1983.09	G12BT	1410	A152A	G	LUC		
	1981.12	1983.09	G12BT	1410	A156A T	G			
	1987.09	1990.06	4G15	1468	C52A, C62A	G	AKE		
	1987.09	1990.06	4G15	1468	C52A, C62A MPI	G	AKE		
	1990.06	1991.11	4G15	1468	C52A, C62A	G	SUM	D1N014	
	1990.06	1991.11	4G15	1468	C52A, C62A MPI	G	SUM	D1N014	
	1983.10	1987.08	G15B	1468	C12A, C12V, C12W	G	SUM		
	1987.09	1990	4G61	1595	C53A, C63A	G	AKE/AKE		D2N028
	1983.10	1988	4G32T	1597	C13A T	G	AKE		
	1991.12	1996.03	4G92	1597	CA4	G	SUM/ AKE+ABS	D1N035	D2N040
1991.12	1996.03	4G92	1597	CC4 4WD	G	SUM/ AKE+ABS	D1N013	D2N040	
1996.03	2000.09	4G92	1597	CJ4A (1 POT CALIPER)	G	SUM	D1N035	D2N040	



Brake Master Cylinder

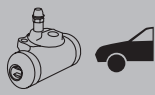

Brake Wheel Cylinder Front

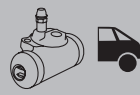

Brake Wheel Cylinder Rear Left

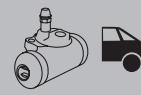

Brake Wheel Cylinder Rear Right

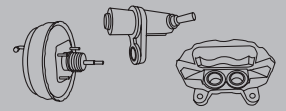

Other Parts

		A: AM-019	A: AM-019	
		A: AM-019	A: AM-019	
MM-069		A: AM-019	A: AM-019	
MM-069		A: AM-019	A: AM-019	
MM-069		A: AM-019	A: AM-019	
MM-069		A: AM-019	A: AM-019	
		A: AM-004	A: AM-004	
MM-008		A: AM-004	A: AM-004	
MM-067		A: AM-005	A: AM-005	
MM-067		A: AM-005	A: AM-005	
MM-070		A: AM-013	A: AM-013	
MM-004		A: AM-004	A: AM-004	
MM-068		A: AM-005	A: AM-005	
MM-008		A: AM-004	A: AM-004	
MF-004		A: AM-004	A: AM-004	
MF-004		A: AM-004	A: AM-004	
MM-067		A: AM-004	A: AM-004	
MM-067		A: AM-004	A: AM-004	
MM-067		A: AM-004	A: AM-004	
MM-067		A: AM-004	A: AM-004	
		A: AM-004	A: AM-004	
MM-011				
		A: AM-004	A: AM-004	
MM-068		A: AM-013	A: AM-013	
MM-070		A: AM-013	A: AM-013	

APPLICATION LIST



CCM

Body Type



Brake Code



Brake Pads Front



Brake Pads Rear

# MITSUBISHI

APPLICATION LIST

COLT	1996.03	2000.09	4G92	1597	CJ4A (2 POT CALIPER)	G		D1N034	D2N040
	1983.10	1987.08	4D65	1795	C14A	D	AKE		
	1987.09	1990.05	4D65	1795	C54, C64	D	AKE		
	1990.08	1991.11	4D65	1795	C54, C64	D	SUM	D1N014	
	1991.08	1994	4D65	1795	CD7A	D		D1N013	D2N040
	1991	1996.03	4G93	1834	CA5A GTI	G	SUM/AKE		D2N040
	1989.11	1991	4G67	1836	C58 GTI	G	SUM/AKE	D1N035	D2N028
CORDIA	1982.02	1987.10	G32B	1597	A212A	G	AKE		
	1982.02	1984.07	G32BT	1597	A212 T	G	AKE		
	1983.06	1989.10	G62BT	1795	A213A T	G	AKE		
ECLIPSE	1989.09	1993.05	4G63	1997	D22A GS	G	SUM/AKE	D1N035	D2N028
	1995.08	1998.02	4G63	1997	D32	G	SUM/SUM	D1N035	D2N032
	1989.09	1993.05	4G63-T	1997	D27A GSR4 T	G	AKE	D1N035	D2N028
GALANT	1990.05	1992.10	4G32	1597	E31A	G	SUM	D1N011	
	1987.08	1990.05	4G37	1755	E32A	G	AKE		
	1990.05	1992.09	4G37	1755	E32A	G	SUM	D1N035	
	1984.03	1986.06	4D65T	1795	E14A T	D	AKE		
	1986.06	1988	4D65T	1795	E14A T	D	AKE		
	1988.01	1990.05	4D65T	1795	E34 T	D	AKE		
	1990.06	1992.06	4D65T	1795	E34 T	D	SUM	D1N011	
	1992.02	1997.03	4G93	1834	E52 2WD	G	SUM	D1N035	
	1987.08	1992.09	4G63	1997	E33A/E39A 4WS	G	AKE		D2N028
	1990.01	1992.09	4G63	1997	E39A 4WD	G	SUM/AKE	D1N034	D2N028
	1992.02	1997.03	4G63	1997	E55A 16V	G	SUM/AKE		
	1997	2000	4G63	1997	EA2A 16V	G	AKE/AKE+ABS	D1N034	D2N032
	1983.08	1985.12	4G63B	1997	E15A	G	AKE		
	1983.08	1985.12	4G63BT	1997	E15A T	G	AKE		
	1987.09	1989.07	4G63T	1997	E39A TWI 4WS	G	AKE		D2N028
	1986.01	1986.07	G63B	1997	E15A	G	AKE		
	1992.02	1996.09	4D68T	1998	E57A TDI	D	SUM	D1N035	
	1997		4D68T	1998	EA6A TDI	D			
	1992.02	1996.08	6A12	1999	E54A V6 DOHC	G	SUM/SUM	D1N034	D2N032
	1980.04	1983.07	4D55	2346	A167A	D	SUM		
1999.02	2000.09	4G64	2351	EA2A Gdi	G				
2000.09	2004.10	4G64	2351	EA3A Gdi	G				
1992.02	1997.03	6G73	2497	E88A, F13 V6	G	AKE/SUM	D1N034	D2N032	
1997	2000.09	6A13	2498	EA5A V6	G	AKE/AKE+ABS	D1N034	D2N032	
GRANDIS	2004.04		4G69	2378	NA4W	G		D1N048	
L200	1996.11		4G64SI	2351	K75T	G			
	1992.06	1996.08	4D56	2477	K_4T	D			
	2001.08		4D56	2477	K74T	D			
L200 pick-up	1981.09	1991.06	4G63	1997	K12/22T	G			
	1986.11	1996.12	4G63	1997	K12T	G	SUM	D1N033	
	1987.12	1995.12	4G63	1997	K22T 4WD	G	SUM	D1N033	
	1982.10		4G63B	1997	L026G 4WD	G	SUM	D1N033	



Brake Master Cylinder



Brake Wheel Cylinder Front

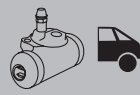

Brake Wheel Cylinder Rear Left

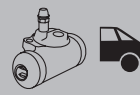

Brake Wheel Cylinder Rear Right

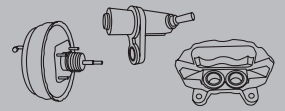

Other Parts

MM-070		A: AM-013	A: AM-013	
MM-009		A: AM-004	A: AM-004	
MM-011		A: AM-005	A: AM-005	
MM-011		A: AM-005	A: AM-005	
MM-041		A: AM-013	A: AM-013	
MM-011				
MM-004		A: AM-009	A: AM-009	
		A: AM-009	A: AM-009	
MM-004		A: AM-009	A: AM-009	
MM-024				
MM-027				
MM-024		A: AM-009	A: AM-009	
MM-024		A: AM-009	A: AM-009	
MM-004		A: AM-009	A: AM-009	
MM-004		A: AM-009	A: AM-009	
MM-024		A: AM-009	A: AM-009	
MM-024		A: AM-009	A: AM-009	
MM-024		A: AM-012	A: AM-012	
MM-057				
MM-057				
MM-073				
MM-072				
MM-004				
MM-023				
MM-024				
MM-004				
MM-024		A: AM-012	A: AM-012	
MM-072		A: AM-012	A: AM-012	
MM-073				
MM-020				
MM-072				
MM-072				
MM-073				
MM-072		A: AN-054	A: AN-054	
MM-052		A: AM-010L	A: AM-010R	
MZ-042		A: AZ-001	A: AZ-001	
MM-052				
MM-045		A: AM-010L	A: AM-010R	
MM-045		A: AM-010L	A: AM-010R	
MM-045		A: AM-010L	A: AM-010R	

APPLICATION LIST



CCM

Body Type



Brake Code



Brake Pads Front



Brake Pads Rear

# APPLICATION LIST

## mitsubishi

L200 pick-up	1987.01	1996.12	4D56	2476	K14T 2WD, K24T 4WD	D	SUM	D1N033	
	1997.01	1997.08	4D56	2476	K64 2WD	D	AKE	D1N042	
	1992.07	1996.12	4D56T	2476	K34T 4WD	D	SUM	D1N033	
	1997.01		4D56T	2476	K74T 4WD	D	AKE	D1N034	
L300	1979.06	1986.10	4G32	1597	L032P, L034P	G	AKE		
	1982.08	1986.03	4G32	1597	L033P, L062P	G	SUM		
	1986.04	1994.12	G32B	1597	P02V, P12V, LO63P	G	SUM	D1N033	
	1986.04	1995.12	G63B	1997	P03W, P13	G	SUM	D1N033	
	1986.04	1992.04	G63B	1997	P23W, P23V 4WD	G			
	1996.01	1999.04	G63B	1997	P03W, P13	G	SUM	D1N042	
	1982.10	1986.03	4D55	2346	L038P, L068P, L068PW	D			
	1986.11	1994.05	4G64	2351	P04, P14, P24V/W	G	SUM	D1N033	
	1986.04	1994.09	4D56	2476	L039P	D	AKE		
	1986.04	1994.03	4D56	2476	P05V, P15V/W, P25V 2&4WD	D	SUM	D1N033	
1986.04	1994	4D56T	2476	P05W, P25W 2&4WD T	D	SUM	D1N033		
L400	1996.09	1999.04	4G63	1997	PA3V, PB3V	G	AKE	D1N042	
	1996.09	1999.04	4G64	2351	PA4V, PD4V	G	AKE	D1N034	
	1996.09	1999.04	4D56	2476	PA5V/W, PB5V, PD5V T	D	AKE/AKE+ABS	D1N042	
LANCER	1987.09	1993.12	4G13	1298	C51A, C61A	G		D1N014	
	1996	2001.07	4G13	1298	CK1A	G		D1N013	
	1991.12	1996.02	4G13M	1299	CB1A	G		D1N013	D2N040
	1980.01	1986.12	G12B	1410	A172A	G			
	1987.08	1992.04	4G15	1468	C52A, C62A	G		D1N014	
	1987.08	1992.04	4G15	1468	C52A, C62A MPI	G		D1N014	
	1991.12	1996.02	4G92	1597	CD4 4WD	G	SUM/AKE	D1N013	D2N040
	1983.10	1987.08	4D65	1795	C14A	D	AKE		
	1987.08	1991.12	4D65	1795	C54A, C64A	D		D1N014	
	1990.04	1996	4G67/93	1834	CB5	G	SUM/AKE+ABS	D1N035	D2N040
1992.04	1999.05	4D68	1998	CB8	D	SUM/AKE	D1N013	D2N040	
2000				CS			D1N004		
OUTLANDER II	2007.09		4B12	2360	CW5 mivec	G		D1N048	
PAJERO	1982.04	1986.05	4D55	2346	L043G, L048G T	D	SUM		
	1991.06	1994.08	4G64	2351	V21	G	AKE/AKE	D1N034	D2N037
	1987.09	1991.02	4D56	2476	L044G, L049G	D	SUM	D1N033	
	1986.04	1987.05	4D56T	2476	L044G, L049G T	D	SUM		
	1987.06	1991.02	4D56T	2476	L044G, L049G T	D	SUM	D1N033	
	1988.09	1991.02	4D56T	2476	L144, L149G TWI	D	SUM	D1N033	
	1990.10	1999.08	4D56T	2476	V14/24/34/44	D	AKE/AKE	D1N033	D2N037
	1991.01	1997.05	4D56T	2476	V24C/V/W/WG	D		D1N034	D2N037
	1992.10	1994.06	4D56T	2476	V24WC	D		D1N034	D2N037
	1998.11	2002	4D56/4D56T	2477	V64W, V94W	D		D1N034	D2N037
	1982.04	1986.05	4G54B/4G54	2555	L042G, L047G	G	SUM		





Brake Master Cylinder

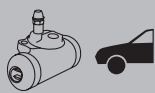

Brake Wheel Cylinder Front

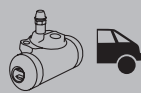

Brake Wheel Cylinder Rear Left

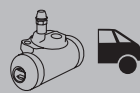

Brake Wheel Cylinder Rear Right

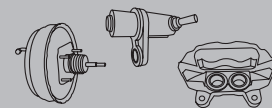

Other Parts

MM-063		A: AM-010L	A: AM-010R	
MM-052		A: AM-010L	A: AM-010R	BC FL: EM-043L BC FR: EM-043R
MM-063		A: AM-001L	A: AM-001R	
		A: AM-003L	A: AM-003R	
		A: AM-003L	A: AM-003R	
MM-051		A: AM-003L	A: AM-003R	
MM-034		A: AM-003L	A: AM-003R	
MM-051		A: AM-003L	A: AM-003R	
		A: AM-003L	A: AM-003R	
MM-034		A: AM-003L	A: AM-003R	
MM-034		A: AM-003L	A: AM-003R	
MM-034		A: AM-003L	A: AM-003R	
MM-034		A: AM-003L	A: AM-003R	
			A: AM-001R	
MM-011		A: AM-005	A: AM-005	
MM-070		A: AM-013	A: AM-013	
MM-068		A: AM-005	A: AM-005	
MM-008				
MM-067		A: AM-004	A: AM-004	
MM-067		A: AM-004	A: AM-004	
MM-009		A: AM-004	A: AM-004	
MM-011		A: AM-009	A: AM-009	
MM-041				
MM-041		A: AM-013	A: AM-013	
MM-001		A: AM-003L	A: AM-003R	
MM-063		A: AM-003L	A: AM-003R	
MM-031		A: AM-001L	A: AM-001R	
MM-045				
MM-063		A: AM-003L	A: AM-003R	

APPLICATION LIST



CCM

Body Type



Brake Code



Brake Pads Front



Brake Pads Rear

# APPLICATION LIST

## mitsubishi

PAJERO	1986.06	1988.11	4G54/ G54B	2555	L042G, L047G	G	SUM	D1N033	
	1988.11	1991	4G54/ G54B	2555	L042G, L047G	G			
	1993.11	1999.08	4M40	2835	V26, V46 TDI	D	AKE/AKE	D1N034	D2N037
	1994.06	1999.08	4M40T	2835	V26WG	D		D1N034	D2N037
	1983.01	1991.04	6G72	2972	L141, L146 V6	G	SUM	D1N033	
	1991.01	1997.03	6G72	2972	V23/43 V6	G	AKE/AKE	D1N034	D2N037
	2000.04		4M41	3200	V60 DI-D	D	SUM/AKE	D1N003	
	1993.11	1997.10	6G74	3497	V25, V45	G	AKE/AKE	D1N034	D2N037
	1997.11	1999.08	6G74	3497	V25, V45	G	AKE/AKE	D1N034	D2N037
	1999.06		6G74	3497	V65, V75 GDI, V6	G	SUM/AKE	D1N003	
PAJERO PININ	1998.03	2000.06	4G93	1834	H66W	G	SUM	D1N021	D2N032
	2000.06	2002.09	4G94	1998	H67W, H77W	G	SUM	D1N021	D2N032
PAJERO SPORT	1998.11	1999.04	4D56T	2476	K94 T	D	AKE	D1N034	D2N022
	1998.11	2000	6G72	2972	K96 V6	G	AKE	D1N034	D2N022
SAPPORO	1980.05	1983.07	G32B	1597	A161	G			
SIGMA	1991	1994	6G72	2972	F16A estate	G	AKE	D1N034	
	1991	1994	6G72	2972	F16A saloon	G	AKE	D1N034	
	1993.01	1996	6G72	2972	F07W estate	G	AKE	D1N034	
	1993.01	1996	6G72	2972	F07W saloon	G	AKE	D1N034	
SPACE GEAR	1994.12	2000.05	4G63	1997	PA3W	G	AKE	D1N042	
	1994.12	2000.05	4G64	2351	PA4W	G	AKE	D1N042	
	1994.12	1997.09	4G64	2351	PD4W 4WD	G	AKE/ AKE+ABS	D1N034	D2N037
	1994.12	2000.05	4D56	2476	PA5W T	D	AKE	D1N042	
	1994.12	2000.05	4D56	2476	PD5W 4WD T	D	AKE/ AKE+ABS	D1N034	
SPACE RUNNER	1991	1999	4G93	1834	N21 4WD	G			
	1991.06	1999	4G93	1834	N11	G	SUM	D1N035	
	1992	1999	4D68T	1998	N18 T	D	SUM	D1N042	
SPACE STAR	1998.06	2000	4G13	1299	DG1A	G	LUC		
	2000		4G13	1299	DG1A	G			
	1998.06	2002	4G93	1834	DG5A GDI	G	LUC		
	2002.02		F9Q2	1870	DG0 115 cv	D			
SPACE WAGON	1991.05	1992	4G93	1755	N31W	G	SUM	D1N035	
	1991.05	1992	4G93	1755	N41W 4WD	G	SUM/AKE		
	1984.09	1991.05	4D65T	1795	D09W T	D	AKE		
	1991.05	1998	4D65T	1795	N35W T	D	SUM/AKE		
	1992	1997.10	4G63	1997	N43 4WD	G	SUM/AKE		
	1992.06	1998	4G63	1997	N33	G	SUM	D1N035	
	1984.05	1991	G63B	1997	D08W 4WD	G	AKE		
	1985.03	1988	G63B	1997	D04W	G			
	1992	1998	4D68T	1998	N38 T	D	SUM/AKE		
1998		4G64	2351	N84, N94 GDI	G	AKE	D1N034		
STARION	1989.03	1991.09	4G54T	2555	A187A	G	AKE		
TREDIA	1982.02	1984.07	G12B	1410	A211A	G			
	1982.02	1985.05	G32B	1597	A212A	G	AKE		
	1982.02	1984.07	G32BT	1597	A212A T	G			



Brake Master Cylinder

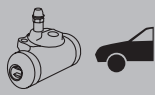

Brake Wheel Cylinder Front

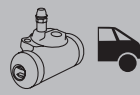

Brake Wheel Cylinder Rear Left

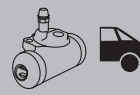

Brake Wheel Cylinder Rear Right

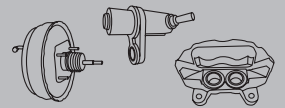

Other Parts

MM-063		A: AM-003L	A: AM-003R	
MM-063		A: AM-003L	A: AM-003R	
MM-045		A: AM-010L	A: AM-010R	BC FL: EM-043L BC FR: EM-043R
MM-031		A: AM-001L	A: AM-001R	
MM-045				
MM-045		A: AM-010L	A: AM-010R	
MM-045		A: AM-010L	A: AM-010R	
		A: AM-020	A: AM-020	
		A: AM-020	A: AM-020	
MM-052				
MM-052				
MM-020				
MM-040				
MM-059			A: AM-001R	
MM-059			A: AM-001R	
MM-071				
MM-071				
MM-059			A: AM-001R	
MM-056		A: AM-005	A: AM-005	
MM-056		A: AM-005	A: AM-005	
MM-040		A: AM-005	A: AM-005	
		A: AM-019	A: AM-019	
		A: AM-019	A: AM-019	
		A: AM-019	A: AM-019	
		A: AM-019	A: AM-019	
MM-056		A: AM-004	A: AM-004	
MM-017		A: AM-007	A: AM-007	
MM-040		A: AM-004	A: AM-004	
MM-056		A: AM-004	A: AM-004	
MM-056		A: AM-004	A: AM-004	
MM-004		A: AM-006R	A: AM-006R	
MM-004		A: AM-007	A: AM-007	
MM-040		A: AM-004	A: AM-004	
		A: AM-020	A: AM-020	
MM-029				
MM-004		A: AM-004	A: AM-004	
MM-004		A: AM-009	A: AM-009	
		A: AM-009	A: AM-009	

APPLICATION LIST



CCM

Body Type



Brake Code

Brake Pads  
FrontBrake Pads  
Rear

# mitsubishi

TREDIA	1983.06	1985.07	G62BT	1795	A213A T	G	AKE		
--------	---------	---------	-------	------	---------	---	-----	--	--

# NISSAN

100NX	1990.10	1996.07	GA16DE	1597	B13 CPE	G	SUM/ SUM+ABS		B2N022
	1990.10	1992.10	SR20DE	1998	B13 CPE	G	AKE/SUM		B2N022
	1992.10	1995.09	SR20DE	1998	B13 CPE	G	AKE/SUM		B2N022
120A FII (CHERRY)	1974.09	1978.02	A12	1171	F10 DATSUN 120A FII	G			
	1978.02	1978.05	A12	1171	F10 DATSUN 120A FII	G			
120Y (SUNNY)	1973.05	1977.10	A12	1171	B210 DATSUN 120Y	G			
180SX	1989.03	1991.01	CA18DT	1800	KRS13, RS13 TCT	G			B2N016
	1991.01	1999.12	SR20DT	2000	KRPS13, RPS13 TCT	G		B1N019	B2N016
200SX	1988.09	1991.09	CA18DET	1809	S13 T	G			
	1991.09	1995	CA18DET	1809	S13 T	G	AKE	B1N019	
	1993.10	1999.12	SR20DET	1998	S14 T	G	SUM	B1N006	B2N016
300ZX	1984.01	1987.02	VG30ET	2960	Z31 300 ZX T	G		B1N003	
ALMERA	1995.10	1997.09	GA14DE	1392	N15	G	AKE/ AKE+ABS		B2N029
	1997.09	2000.	GA14DE	1392	N15	G	AKE/ AKE+ABS		B2N022
	1995.10	1998.09	GA16DE	1597	N15	G	AKE/ AKE+ABS		B2N029
	1995.10	2000.07	CD20	1973	N15	D	AKE/ AKE+ABS		
	1995.10	2000.	SR20DE	1998	N15 GTI	G	SUM/SUM		
ALMERA II	2004.04		K9II	1461	N16 Dci	D			
	2003	2004.03	K9K	1461	DCI	D			
	2000.03		QG15DE	1497	N16	G	LUC Ø 256		
	2000	2002	QG18DE	1769	N16	G	LUC Ø 256		
	2000.01			2000	N16 Gti	G			B2N022
	2000.04	2003.05	YD- 22DDTI	2184	N16 T	D	LUC Ø 280		
ALMERA TINO	2000.04		QG18DE	1769	V10	G		B1N039	B2N022
	2000.04	2003.05	SR20DE	1998	V10	G		B1N039	B2N022
	2000.04	2003.05	YD- 22DDTI	2184	V10	D			
BLUEBIRD	1979.10	1982.09	L/Z16	1595	910	G			
	1983.10	1987.09	CA16S	1598	U11	G	AKE-WI	B1N003	
	1985.10	1990	CA16S	1598	T12	G	AKE-WI	B1N003	
	1986.07	1988.08	CA16S	1598	T72 made in UK	G	AKE+WI	B1N003	
	1988.09	1990	CA16S	1598	T72 made in UK	G	AKE	B1N003	
	1986.07	1988.08	CA18NS	1796	T72 made in UK	G	AKE+WI	B1N003	
	1988.08	1990	CA18NS	1796	T72 made in UK	G	AKE+WI	B1N003	
	1983.10	1985.08	CA18	1809	U11	G	AKE-WI	B1N003	
	1985.08	1987.09	CA18	1809	U11	G	AKE-WI	B1N003	
1987.09	1990	CA18D	1809	U12 4WD	G		B1N003		



Brake Master Cylinder



Brake Wheel Cylinder Front

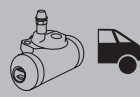

Brake Wheel Cylinder Rear Left

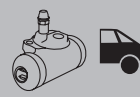

Brake Wheel Cylinder Rear Right

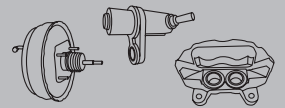

Other Parts

MM-004		A: AM-009	A: AM-009	
--------	--	-----------	-----------	--

MN-089		A: AN-011	A: AN-011	
MN-091				
MN-091				
		A: AN-013	A: AN-013	
		A: AN-013	A: AN-013	
		A: AN-013	A: AN-013	
MN-092				
MN-092				
MN-092				
MN-092				
MN-109				
MN-109				
MN-109		A: AN-050	A: AN-050	
MN-109				
MN-119				
MN-137				
MN-137				
MN-137				
MN-137				
MN-119				
MN-906				
MN-906				
MN-906				
		A: AN-020	A: AN-020	
		A: AN-017	A: AN-017	
MN-136		A: AN-050	A: AN-050	
MN-136		A: AN-050	A: AN-050	
MN-136		A: AN-050	A: AN-050	
		A: AN-013	A: AN-013	
MN-136		A: AN-017	A: AN-017	
MN-136		A: AN-017	A: AN-017	

APPLICATION LIST



CCM

Body Type



Brake Code



Brake Pads Front



Brake Pads Rear

# NISSAN

APPLICATION LIST

BLUEBIRD	1988.01	1990	CA18DE	1809	T12	G	AKE	B1N003	
	1987.09	1990	CA18DET	1809	U12 T 4WD	G		B1N003	
	1985.08	1987.09	CA18ET	1809	U11 T	G		B1N003	
	1985.10	1988.01	CA18ET	1809	T12, T72 T	G	AKE	B1N003	
	1988.08	1990	CA18ET	1809	T72 T made in UK	G	AKE	B1N003	
	1985.10		CA18I	1809	T12	G	AKE-WI	B1N003	
	1987.09	1989.10	CA18I	1809	U12 2WD	G		B1N003	
	1980.03	1980.12	LD20	1952	910	D			
	1981.01	1983.10	LD20	1952	910	D			
	1983.10	1985.08	LD20	1952	U11	D			
	1985.09	1987	LD20	1952	U11	D		B1N003	
	1985.12	1988.01	LD20	1952	T12	D	AKE-WI	B1N003	
	1988	1990	LD20	1952	T72 made in UK	D	AKE+WI	B1N003	
	1981.02	1983.10	LD20T	1952	910	D			
	1981.02	1983.10	LD20T	1952	910 w/ power steering	D			
	1983.10	1990.05	LD20T	1952	U11 T	D		B1N003	
	1986.01	1990	CA20E	1973	T12	G	AKE-WI	B1N003	
	1988.07	1988.08	CA20E	1973	T72 made in UK	G	AKE+WI	B1N003	
	1988.08	1990	CA20E	1973	T72 made in UK	G	AKE+WI	B1N003	
	1983.10	1985.08	CA20S	1973	U11	G	AKE-WI	B1N003	
	1986.01	1990.09	CA20S	1973	T12	G	AKE-WI	B1N003	
	1987.07	1988	CA20S	1973	T72 made in UK	G	AKE+WI	B1N003	
	1988.02	1990	CA20S	1973	U12 for Europe	G		B1N003	
1988.08	1990	CA20S	1973	T72 made in UK	G	AKE+WI	B1N003		
1987.09	1991.08	LD20-II	1998	U12	D		B1N003		
1986.01	1987	VG20E	1998	U11	G	AKE-WI	B1N003		
1984.10	1987	VG20ET	1998	U11 T	G		B1N003		
CABSTAR	1992.01	1995.06	NA16	1600	F23	G		B1N003	
	1992.10	1995.06	TD23	2289	F23	D		B1N003	
CEDRIC	1987.05	1989.05	VG30	2960	Y30	G	AKE	B1N004	
CHERRY	1978.05	1981.07	A10	988	N10	G			
	1981.08	1982.06	E10	988	N10	G			
	1982.04	1986	E10	988	N12	G	SUM		
	1978.05	1981.07	A12	1171	N10	G			
	1981.08	1982.06	E13	1270	N10	G			
	1982.04	1986.05	E13S	1270	N12	G	SUM		
	1981.08	1982.06	E15	1487	N10	G			
	1982.04	1986.05	E15S/E	1488	N12	G	SUM		
	1983.07	1986.05	E15T	1488	N12 T	G	AKE		
	1982.10	1986.05	CD17	1681	N12	D	AKE		
LAUREL	1984.11	1987.09	CA20	1973	JC32	G	AKE	B1N003	
	1980.11	1984.10	L20S	1998	JC31	G			
	1985.09	1987.09	RB20E	1998	JC32	G	AKE	B1N003	
	1980.11	1984.10	L24S/ L24E	2393	JC31	G			
	1984.11	1989.12	L24S/ L24E	2393	JC32	G	AKE	B1N003	
1980.11	1984.12	LD28	2793	JC31	D				



Brake Master Cylinder

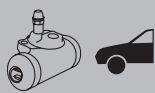

Brake Wheel Cylinder Front

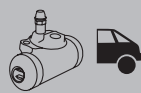

Brake Wheel Cylinder Rear Left

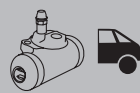

Brake Wheel Cylinder Rear Right

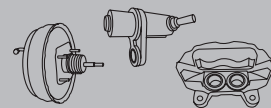

Other Parts

MN-088		A: AN-017	A: AN-017	
MN-088				
		A: AN-010	A: AN-010	
		A: AN-020	A: AN-020	
		A: AN-020	A: AN-020	
MN-136		A: AN-017	A: AN-017	
MN-136		A: AN-017	A: AN-017	
MN-136		A: AN-013	A: AN-013	
MN-136		A: AN-013	A: AN-013	
		A: AN-020	A: AN-020	
		A: AN-020	A: AN-020	
		A: AN-020	A: AN-020	
		A: AN-050	A: AN-050	
		A: AN-050	A: AN-050	
		A: AN-050	A: AN-050	
		A: AN-050	A: AN-050	
MN-136		A: AN-017	A: AN-017	
MN-136		A: AN-017	A: AN-017	
		A: AN-017	A: AN-017	
MN-015				
MN-016		A: AN-012	A: AN-012	
MN-016		A: AN-012	A: AN-012	
MN-015				
MN-015				
MN-016		A: AN-012	A: AN-012	
MN-016		A: AN-012	A: AN-012	
MN-016		A: AN-012	A: AN-012	
		A: AN-012	A: AN-012	
		A: AN-012	A: AN-012	
		A: AN-008	A: AN-008	
MN-063		A: AN-008	A: AN-008	
		A: AN-008	A: AN-008	
		A: AN-008	A: AN-008	
MN-060		A: AN-008	A: AN-008	
		A: AN-008	A: AN-008	

APPLICATION LIST



CCM

Body Type



Brake Code



Brake Pads Front



Brake Pads Rear

# NISSAN

APPLICATION LIST

LAUREL	1985.01	1987.10	LD28	2793	JC32		D	AKE	B1N003	
	1986.10	1993.04	RD28	2825	JC32		D	AKE	B1N004	
MAXIMA	1988.08	1991.11	VG30E	2960	J30		G	SUM/SUM	B1N019	B2N022
	1991.11	1994.09	VG30E	2960	J30		G	SUM/SUM	B1N019	
MAXIMA QX	1994.11	2000.10	VQ20DE	1995	A32 V6		G	SUM/SUM	B1N019	B2N022
	1994.11	2000.10	VQ30DE	2988	A32 V6		G	SUM/SUM		B2N022
MICRA	1982.10	1985.06	MA10	988	K10		G	AKE		
	1985.06	1992.07	MA10	988	K10		G	AKE+WI	B1N012	
	1982.10	1985.02	MA10T	988	K10 T		G			
	1985.02	1989.01	MA10T	988	K10 T		G			
	1989.01	1992.01	MA10T	988	K10 T		G			
	1985.07	1992.07	MA12	1235	K10		G	AKE+WI	B1N012	
MICRA 2	1989.01	1992.01	MA10	988	K10		G	AKE+WI	B1N012	
	1992.08	1998.02	CG10DE	998	K11		G	AKE/LUC		
	1998.02	2003	CG10DE	998	K11		G	AKE/LUC+ABS		
	1992.08	1995.09	CG13DE	1275	K11		G	AKE/LUC+ABS		
	1995.09	2003	CG13DE	1275	K11		G	AKE/LUC+ABS		
	2000.09	2003.02	CGA3DE	1348	K11 16V 82HP		G			
	1998.02	2003.02	TD15	1527	K11		D	AKE/SUM		
MICRA 3	2003.01	2006.03	CR12DE	1240	K12		G			
	2003.01	2006.03	CR14DE	1386	K12		G			
	2004.04		K9II	1461	K12 DCI		D			
	2003.01	2004.03	K9K	1461	K12 DCI		D			
MICRA 4	2010.		1200	TURBO		G				
MICRA C+C	2005.08	2006.03	HR16DE	1598	K12		G			
MURANO	2005.03		VQ35DE	3498	PNZ50		G		B1N079	B2N064
	1998.02	2001	TD25	2494	D22		D	SUM	B1N011	
NAVARA	1998.02		TD25TI	2494	D22		D	SUM	B1N011	
	1979.11	1983.07	L28	2753	160		G	SUM		
PATROL	1983.08	1985.01	L28	2753	160		G			
	1984.11	1989.02	L28	2753	260		G			
	1990.09	1995.11	RD28T	2820	W260		D	SUM		
	1988.09	1991.10	RD28T	2825	JN#Y60 T made in Japan		D	SUM		
	1988.09	1991.10	RD28T	2825	VSK#Y60 T made in Spain		D	SUM		
	1991.10	1996.03	RD28T	2825	JN#Y60 T made in Japan		D			
	1991.10	1996.03	RD28T	2825	VSK#Y60 T made in Spain		D			
	1996.03	1997	RD28T	2825	JN#Y60 T made in Japan		D	SUM		
	1996.03	1997	RD28T	2825	VSK#Y60 T made in Spain		D	SUM		
	1997.10	2000.05	RD28TI	2826	Y61 DI		D	AKE/AKE+ABS	B1N018	
	2000.02	2004.07	ZD-30DDTi	2953	Y61 DI Short Wheel-base		D			





Brake Master Cylinder

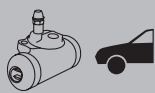

Brake Wheel Cylinder Front

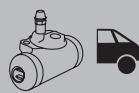

Brake Wheel Cylinder Rear Left



Brake Wheel Cylinder Rear Right

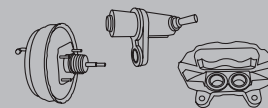

Other Parts

		A: AN-008	A: AN-008	
		A: AN-008	A: AN-008	
		A: AN-002	A: AN-002	
		A: AN-002	A: AN-002	
MN-005		A: AN-002	A: AN-002	
		A: AN-002	A: AN-002	
MN-005		A: AN-002	A: AN-002	
MN-005		A: AN-002	A: AN-002	
		A: AN-002	A: AN-002	
MN-126		A: AN-904	A: AN-904	
		A: AN-904	A: AN-904	
		A: AN-904	A: AN-904	
		A: AN-904	A: AN-904	
MN-126		A: AN-904	A: AN-904	
		A: AN-904	A: AN-904	
		A: AN-051	A: AN-051	
		A: AN-051	A: AN-051	
		A: AN-051	A: AN-051	
		A: AN-051	A: AN-051	
		A: AN-051	A: AN-051	
		A: AN-051	A: AN-051	
		A: AN-001	A: AN-001	
		A: AN-001	A: AN-001	
		A: AN-001	A: AN-001	
MN-012		A: AN-007	A: AN-007	
MN-012		A: AN-007	A: AN-007	
		A: AN-007	A: AN-007	
MN-012		A: AN-007	A: AN-007	
		A: AN-007	A: AN-007	
MN-012		A: AN-007	A: AN-007	
		A: AN-007	A: AN-007	
MN-012		A: AN-007	A: AN-007	
		A: AN-007	A: AN-007	
		A: AN-007	A: AN-007	

APPLICATION LIST



CCM

Body Type



Brake Code



Brake Pads Front



Brake Pads Rear

# NISSAN

APPLICATION LIST

PATROL	2000.08	2004.07	ZD-30DDTi	2953	Y61 DI Long Wheel-base	D			
	1979.11	1983.08	SD33	3246	160	D	SUM		
	1983.08	1984.07	SD33	3246	160	D	SUM		
	1984.08	1988.08	SD33	3246	160	D			
	1983	1990	SD33T	3246	160 T	D			
	1987	1988.02	SD33T	3246	Y60 T	D	SUM		
	1987.08	1998.03	TB42S	4169	Y60	G	SUM/SUM		
	1987.08	1988.10	TD42	4169	Y60	D	SUM/SUM		
	1988.10	1997.03	TD42	4169	Y60	D	SUM/SUM		
	1997.03	1998.03	TD42	4169	Y60	D	SUM/SUM		
PICK-UP	1985.09	1989.09	Z20	1952	D21	G	AKE	B1N003	
	1989.09	1997.01	NA20	2000	D21 2WD	G	AKE	B1N003	
	1989.09		NA20	2000	D21 4WD	G	AKE	B1N003	
	1983.04	1985.01	Z22	2188	720	G			
	1983.01	1985.08	SD23	2289	720	D			
	1985.09	1987.08	SD23	2289	D21	D			
	1992.04	1995.09	KA24E	2389	D21 4WD	G			
	1995.09	1998.02	KA24E	2389	D21 4WD	G			
	1998.02	2001.11	KA24E	2389	D22	G			
	1985.09	1986.10	Z24	2389	D21 2&4WD	G	AKE	B1N003	
	1986.10	1992.04	Z24	2389	D21 2&4WD	G			
	1983.04	1985.08	SD25	2488	720	D			
	1985.09	1988	SD25	2488	D21	D			
	1987.10	1995.10	TD25	2494	D21 2&4WD	D	AKE	B1N003	
	1995.10		TD25	2494	D21 2WD	D	AKE	B1N003	
	1995.10	1998.02	TD25	2494	D21 4WD	D			
	1998.02	2002	TD25Ti	2494	D22	D	SUM		
	1988.11	1998	TD27	2663	D21	D		B1N004	
	1987.08	1998	TD27T	2663	D21 T	D		B1N004	
	1990.09	1995	VG30	2960	D21	G			
1995	1995.10	VG30	2960	D21	G				
PRAIRIE	1982.08	1985.01	E15S	1488	M10	G	AKE		
	1985.01	1988.08	E15S	1488	M10	G	AKE+WI	B1N004	
	1982.08	1985.01	CA18S	1809	M10	G			
	1985.02	1987	CA18S	1809	M10	G			
	1988.09	1992	CA20	1973	M11 2WD	G	SUM	B1N020	
	1988.09	1992	CA20	1973	M11 4WD	G	SUM	B1N021	
	1985.10	1986.08	CA20S	1973	M10	G			
	1986.08	1988.08	CA20S	1973	M10	G			
	1989.01	1994	KA24E	2389	M11 4WD	G	AKE	B1N003	
	1991.01	1992.04	KA24E	2389	M11	G		B1N020	
	1992.04	1995.12	KA24E	2389	M11 2WD	G	SUM	B1N020	
PRESAGE	1998.06	2001.08	KA24	2389	U30	G		B1N062	
PRIMASTAR	2001.03	2000	F9	1870	DCI 80HP	D			
	2001.03	2002	F9Q760	1870	DCI 102HP	D			
	2001.03		F4R720/2	1998	120HP	G			
PRIMERA	1990.06	1996	GA16D	1597	W10 WGN	G	SUM		B2N022





CCM

Body Type



Brake Code



Brake Pads Front



Brake Pads Rear

# NISSAN

APPLICATION LIST

PRIMERA	1993.05	1996.10	GA16DE	1597	W10		G			B2N022
	1990.08	1993.05	GA16DS	1597	W10		G			
	1990.06	1993.05	GA16 DS/E	1597	P10		G	AKE		
	1993.05	1996.06	GA16 DS/E	1597	P10		G	LUC	B1N020	
	1990.05	1995.06	CD20	1974	W10 WGN		D	SUM/SUM		B2N022
	1990.06	1993.05	CD20	1974	P10		D	LUC	B1N020	B2N022
	1993.05	1996.06	CD20	1974	P10		D		B1N020	B2N022
	1995.07	1996.03	CD20	1974	W10		D			B2N022
	1990.06	1993.05	SR20DE/I	1998	P10		G	LUC	B1N020	
	1993.05	1996.06	SR20DE/I	1998	P10		G		B1N020	
	1990.07	1992.09	SR20DI	1998	W10 WGN		G	SUM/SUM		B2N022
	1992.09	1996	SR20DI	1998	W10 WGN		G	SUM/SUM		B2N022
	1991.04	1993.05	SR20DI/E	1998	P10 4WD		G		B1N020	
1993.05	1996.06	SR20DI/E	1998	P10 4WD		G		B1N020		
PRIMERA 2	1996	1998.04	GA16DE	1597	P11		G	LUC		
	1998.04		GA16DE	1597	P11		G	LUC		
	1999.06	2001.12	QG18DE	1769	P11		G	LUC	B1N020	
	1996	1998.04	CD20T	1974	P11 T		D	LUC	B1N020	B2N022
	1998.04	2001.12	CD20T	1974	P11 T		D	LUC	B1N020	
	1996.06	2002	SR20DE	1998	P11		G	LUC	B1N020	
PRIMERA 3	2002.02		QG18E	1769	P12		G	ATE/ATE		B2N040
	2001.01		QR20	1998	TP12		G	ATE/ATE		B2N040
SERENA	1994.03		GA16	1597	C23		G		B1N003	
	1992.10	1995.09	GA16D	1597	C23		G			
	1992.10	1995.09	GA16D	1597	C23M		G	LUC		
	1992.10	1994.09	LD20	1952	C23		D	LUC		
	1992.10	1994.10	SR20DE	1998	C23		G	LUC		
	1994.10	1997.12	SR20DE	1998	C23		G	LUC		
	1994.10		LD23/ GX3	2283	C23		D	LUC		
SILVIA	1983.08	1993.05	CA18ET	1809	S110, S12		G	AKE	B1N003	
	1983.08		CA20	1973	S12		G	AKE	B1N003	
	1983.10	1988.09	FJ20	1990	S12		G	AKE	B1N003	
STANZA	1981.08	1985.10	CA16S	1598	T11		G	AKE		
	1981.06	1985.10	CA18	1809	T11		G	AKE		
SUNNY	1981.10	1985.09	E13S	1270	B11		G	SUM	B1N009	
	1985.09	1990	E13S	1270	B12		G		B1N009	
	1986.05	1991	E13S	1270	N13 SDN, HBK		G	SUM	B1N009	
	1993.07	1995	GA14DE	1392	N14 CYC		G	SUM+WI+ ABS	B1N017	
	1990.10	1993	GA14DS	1392	N14		G	SUM+WI+ ABS	B1N017	
	1988.10	1990	GA14S	1392	N13		G	SUM	B1N009	
	1982.09	1985.09	E15E-T	1488	B11 T		G	SUM	B1N009	
	1981.10	1985.09	E15S	1488	B11		G	SUM	B1N009	
1985.09	1987.09	E15S	1488	B12		G		B1N009		



Brake Master Cylinder



Brake Wheel Cylinder Front

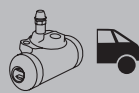

Brake Wheel Cylinder Rear Left

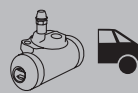

Brake Wheel Cylinder Rear Right

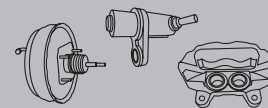

Other Parts

MN-100		A: AN-013	A: AN-013	
		A: AN-020	A: AN-020	
		A: AN-020	A: AN-020	
MN-100		A: AN-013	A: AN-013	BC LR: EN-085LR BC RR: EN-085RR
MN-901		A: AN-052L	A: AN-052R	
MN-901		A: AN-052L	A: AN-052R	
MN-100		A: AN-013	A: AN-013	
MN-100				
MN-100				
MN-100				BC LR: EN-085LR BC RR: EN-085RR
MN-100				BC LR: EN-085LR BC RR: EN-085RR
MN-128		A: AN-903	A: AN-903	
MN-128		A: AN-903	A: AN-903	
MN-128		A: AN-903	A: AN-903	
MN-131				
MN-128				
MN-134		A: AN-906	A: AN-906	
MN-134		A: AN-906	A: AN-906	
MN-134		A: AN-906	A: AN-906	
MN-134		A: AN-010	A: AN-010	
MN-134		A: AN-010	A: AN-010	
MN-134		A: AN-906	A: AN-906	
MN-072		A: AN-008	A: AN-008	
		A: AN-017	A: AN-017	
		A: AN-017	A: AN-017	
MN-016		A: AN-044	A: AN-044	
MN-005		A: AN-012	A: AN-012	
MN-132		A: AN-011	A: AN-011	
		A: AN-011	A: AN-011	
MN-103		A: AN-012	A: AN-012	
MN-016		A: AN-044	A: AN-044	
		A: AN-044	A: AN-044	

APPLICATION LIST



CCM

Body Type



Brake Code



Brake Pads Front



Brake Pads Rear

# NISSAN

APPLICATION LIST

SUNNY	1986.05	1988.10	E15S/E	1488	N13 SDN, HBK	G		B1N009	
	1987.09	1989.05	GA15	1497	B12	G		B1N009	
	1990.10	1996.12	GA16 DS/E	1597	N14, Y10	G	SUM+WI +ABS	B1N017	
	1990.10	1995	GA16 DS/E	1597	N14, Y10 4WD	G	SUM+ABS		
	1988.10	1990	GA16i	1597	GB12	G	SUM		
	1988.10	1990	GA16i	1597	GB12 4WD	G			
	1986.08	1990	CA16D	1598	B12	G	AKE		
	1986.06	1990	E16i	1598	N13, B12	G	AKE		
	1986.05	1988.10	E16S	1598	N13	G	AKE		
	1986.08	1988.10	E16S	1598	N13 4WD	G			
	1982.10	1985.09	CD17	1680	B11	D			
	1985.09	1990	CD17	1680	B12	D	AKE		
	1986.05	1990	CD17	1680	N13 SDN, HBK	D	AKE		
	1986.08	1990.01	CA18D	1809	B12	G	AKE		
	1990.10	1995	CD20	1973	N14, Y10	D	SUM+WI+ABS	B1N017	B2N022
	1990	2003			Y10, Y11	G		B1N037	
	1990	1996	SR20DE	1998	N14 GTI	G	AKE/SUM		
	1990.08	1995.06	SR20DET	1998	N14 GTR 4WD	G	AKE/SUM		
	1991.01	1996.01		2000	N14 Dti-R 4x4	D			B2N022
	1994.01				All models	G		B1N017	
1994.01				All models	D		B1N017		
TERRANO	1986.08	1992.07	Z24	2389	D21	G	SUM	B1N003	B2N050
	1987.08	1997.01	TD27	2663	D21	D	SUM		B2N050
	1989.02	1992.07	TD27T	2663	WD21 T	D		B1N003	
	1992.07	1993.10	TD27T	2663	WD21 T	D			B2N050
	1990.01	1995.09	VG30	2960	D21 4WD	G			
	1995.09		VG30	2960	D21 4WD	G			
TERRANO II	1993.02	1994.11	KA24E	2389	R20	G	SUM		B2N050
	1994.11	1996	KA24E	2389	R20	G			B2N050
	1996.05	2002.01	KA24E	2389	R20	G	SUM		B2N050
	1993.02	1996	TD27T	2663	R20 T	D	SUM		B2N050
	1996.06	2003.07	TD27TI	2663	R30A TDI	D	SUM		B2N050
	2002.05		ZD30TI	2953	R20 4WD	D			
TRADE	1994.06		BD30-II	2953	KE0553, KF0553	D	AKE		
	1996.06	1999.01	BD30TI	2953	VC12373/22373/ 32373, VD23373/33373	D			
URVAN	1980.08	1985.02	Z20	1952	E23	G	SUM		
	1985.02	1987.12	Z20	1952	E23	G	SUM		
	1987.01	1995.08	Z20	1952	E24	G	SUM+WI	B1N011	
	1982.04	1985.02	SD23	2289	E23	D	SUM		
	1985.02	1986.10	SD23	2289	E23	D	SUM		
	1986.11		TD23	2289	E24	D	SUM+WI	B1N011	
	1988.12	1996.10	TD25	2494	E24	D	SUM+WI	B1N011	
VANETTE	1981.06	1985.11	A15	1487	C120	G	AKE	B1N003	
	1987.01	1994.12	A15	1487	C220	G	AKE		
	1992.10		GA16	1597	C23M	G	AKE	B1N003	
	1984.10	1985.12	LD20	1952	C120	D	AKE	B1N003	



Brake Master Cylinder

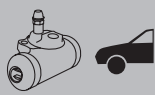

Brake Wheel Cylinder Front

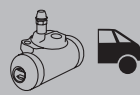

Brake Wheel Cylinder Rear Left

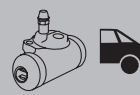

Brake Wheel Cylinder Rear Right

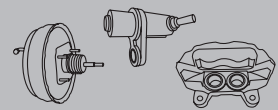

Other Parts

		A: AN-012	A: AN-012	
MN-132		A: AN-011	A: AN-011	
MN-104				
MN-107		A: AN-012	A: AN-012	
		A: AN-016	A: AN-016	
		A: AN-050	A: AN-050	
		A: AN-012	A: AN-012	
		A: AN-012	A: AN-012	
		A: AN-012	A: AN-012	
		A: AN-044	A: AN-044	
MN-106		A: AN-012	A: AN-012	
		A: AN-012	A: AN-012	
		A: AN-050	A: AN-050	
MN-132		A: AN-011	A: AN-011	
MN-091				
MN-139				
MN-135		A: AN-004	A: AN-004	
MN-135		A: AN-004	A: AN-004	
MN-135		A: AN-004	A: AN-004	
MN-111				
MN-111				
		A: AN-003	A: AN-003	
		A: AN-053	A: AN-053	
		A: AN-003	A: AN-003	
		A: AN-053	A: AN-053	
		A: AN-052	A: AN-052	
		A: AN-052	A: AN-052	
		A: AN-053	A: AN-053	
		A: AN-054	A: AN-054	
		A: AN-009	A: AN-009	
		A: AN-009	A: AN-009	
		A: AN-009	A: AN-009	
		A: AN-041	A: AN-041	
		A: AN-041	A: AN-041	
MN-034				
MN-034		A: AN-010	A: AN-010	

APPLICATION LIST



CCM

Body Type



Brake Code



Brake Pads Front



Brake Pads Rear

# NISSAN

Model	Start	End	CCM	Body Type	Brake Code	Brake Pads Front	Brake Pads Rear		
VANETTE	1985.12	1990.05	LD20	1952	C22	D			
	1990.05	1995.12	LD20	1952	C22	D			
	1992.10		LD20	1952	C23M	D	AKE	B1N003	
	1987.04	1990.05	LD20-II	1952	C220	D	AKE	B1N003	
	1990.05	1994.03	LD20-II	1952	C220	D			
	1984.10	1986.08	Z20	1952	C120	G	AKE	B1N003	
	1986.09	1990.05	Z20	1952	C22	G			
	1985.09		CA20	1973	C22	G			
	1995.03		LD23	2283	C23M	D	AKE	B1N003	
	1986.09	1990.05	Z24-I	2389	C22	G			
	1990.05	1993.08	Z24-I	2389	C22	G			
X-TRAIL	2000.10	2002.12	QR20DE	1998	NT30	G		B1N062	B2N064
	2002.12	2003.09	QR20DE	1998	NT30	G		B1N062	B2N064
	2003.09		QR20DE	1998	NT30	G		B1N062	B2N064
	2000.10	2002.12	YD22ETI	2184	T30	D		B1N062	B2N064
	2002.12	2003.09	YD22ETI	2184	T30	D		B1N062	B2N064
	2003.09		YD22ETI	2184	T30	D		B1N062	B2N064

# OPEL

AGILA	2003.08		Z13DT	1248	H00	D		
ASCONA C	1981.09	1988.08	13N	1297	fr E/G nr 1696058	G	ATE/GM	
	1981.09	1986.07	13S	1297	to E/G nr 19569999	G	ATE/GM	
	1986.08	1988.08	13S	1297	fr E/G nr 19570000	G	ATE/GM	
	1981.09	1988.08	16D/ 16DA	1598	Type C fr E/G nr 14310805 to 14498630	D		
	1981.09	1988.08	16DA	1598	Type C fr E/G nr 14478631	D		
	1981.09	1988.08	18E	1796	Type C fr E/G nr 14348331	G		
	1986.08	1988.08	C20NE, 20NE/ SHE	1998	Type C	G	GM/ATE	
ASTRA	1998.02	2000.08	X17DTL	1700	F35	D	+ABS	
	1992.03	1998.09	C18NZ	1796	chss nr 14330716 to 14608700	G		
			C20NE	1998	chss nr 14330716 to 14608700	G		
ASTRA F	1996.01	1998.01	X14XE	1389	51, 52, 54, 58, 59, 56, 57	G		
	1996.01	2001.03	X14XE	1389	53B	G		
	1991.10	1993.04	C16NZ	1598	55	G		
	1992.03	1994.08	C16NZ	1598	56, 57	G		
	1991.09	1998.01	C16NZ/ SE	1598	51, 52, 53, 54, 58, 59	G		
	1992.03	1994.12	C16SE	1598	51, 52, 53, 54, 56, 57, 58, 59	G		
	1993.02	1996.07	X16SZ	1598	55	G		
1993.03	1996.08	X16SZ	1598	53B	G			





Brake Master Cylinder

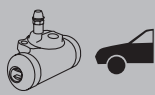

Brake Wheel Cylinder Front

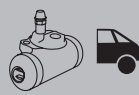

Brake Wheel Cylinder Rear Left

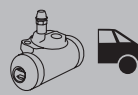

Brake Wheel Cylinder Rear Right

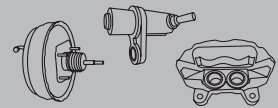

Other Parts

MN-127		A: AN-013	A: AN-013	
MN-903		A: AN-013	A: AN-013	
MN-127		A: AN-010	A: AN-010	
MN-127		A: AN-010	A: AN-010	
MN-903		A: AN-016	A: AN-016	
MN-903				
MN-134		A: AN-906	A: AN-906	
MN-129		A: AN-010	A: AN-010	
MN-129		A: AN-010	A: AN-010	

MS-042				
		A: AE-OP02	A: AE-OP02	
		A: AE-OP02	A: AE-OP02	
		A: AE-OP01	A: AE-OP01	
		A: AE-OP01	A: AE-OP01	
		A: AE-OP01	A: AE-OP01	
		A: AE-OP02	A: AE-OP02	
		A: AE-OP02	A: AE-OP02	
		A: AE-OP02	A: AE-OP02	
		A: AE-OP01	A: AE-OP01	
		A: AE-OP01	A: AE-OP01	
		A: AE-OP01	A: AE-OP01	
		A: AE-OP02	A: AE-OP02	
		A: AE-OP02	A: AE-OP02	
		A: AE-OP02	A: AE-OP02	
		A: AE-OP01	A: AE-OP01	
		A: AE-OP02	A: AE-OP02	
		A: AE-OP01	A: AE-OP01	
		A: AE-OP02	A: AE-OP02	
		A: AE-OP02	A: AE-OP02	

APPLICATION LIST



CCM

Body Type



Brake Code



Brake Pads Front



Brake Pads Rear

# OPEL

APPLICATION LIST

ASTRA F	1993.05	1996.07	X16SZ	1598	51, 52, 53B, 54, 56, 57, 58, 59	G			
	1991.09	1996.01	X16SZR	1598	51, 52	G			
	1996.08	1998.09	X16SZR	1598	51, 52, 53B, 54, 56, 57, 58, 59	G			
	1991.12	1992.09	17D	1700	51, 52, 53, 54, 56, 57, 58, 59	D			
	1991.12	1992.09	17D	1700	55 Van	D			
	1992.07	1998.09	17DR	1700	51, 52, 56, 57	D			
	1992.07	1999.01	17DR	1700	55 VAN	D			
ASTRA G	1998.09	2004.09	X14XE, Z14XE	1389	F69 16V	G			
	2000.02	2005.01	Y17DT	1686	F48, F08, F35, F69	D	+ABS		
	2003.04	2005.01	Z17DTL	1686	F48, F08, F35, F69	D			
	1999.08	2005.01	X20DTH, Y20DTH	1995	F69	D			
COMBO	1999.08	2001.10	X14XE	1398	71	G			
	2000.09		Y17DT	1686	Box Body	D			
	2001.10		Y17DT	1686		D			
	2001.10		Y17DTL	1686		D			
CORSA A	1982.09	1993.03	15D/15TD	1488	fr E/G nr 804795 to 909999	D			
	1982.09	1993.03	15D/15TD	1488	to E/G nr 804794	D			
	1988.08	1992.09	C16NZ, E16SE	1598	93, 94, 98, 99	G			
	1992.02	1993.03	C16SE	1598	93, 94, 98, 99	G			
	1989.09	1993.03	C16SEI	1598	93, 94, 98, 99	G			
	1988.05	1992.03	E16SE	1598	93, 94, 98, 99	G			
CORSA B	1996.11	2000.09	X10XE	973	73, 78, 79, F35	G			
	1994.09	2000.09	X14XE	1389	73, 78, 79, F35	G			
	1993.03	2000.09	15DT/X15DT	1488	73, 78, 79, F35	D			
	1993.03	2000.09	15TD	1488	73, 78, 79, F35	D			
	1996.02	2000.09	17D/X17D	1686	73, 78, 79, F35	D			
CORSA C	2000.09		Y17DTL	1686	F08, F68, W5L	D			
FRONTERA A	1991.10	1995	C20NE	1998	52S	G	SUM		
	1995.04	1998	X20SE	1998	55SA	G	SUM		
KADETT E	1986.09		12ST	1196	Type E fr E/G nr 1131437 or 19506000	G	ATE/GM		
	1986.09	1993.02	C13N/13N/13NB/13S	1297	Type E fr E/G nr 1696057 or 16599999	G	ATE/GM		
	1989.01		C14NZ/14NV	1389	Type E	G	ATE/GM		
	1986.08	1989	16DA	1588	Type E fr E/G nr 14478631	D	ATE/GM		
	1986.08	1993.02	#16#	1598	Type E	G	ATE/GM		
		1986.07	16D/16DA	1598	Type E fr E/G nr 14310805 to 14498630	D	ATE/GM		



Brake Master Cylinder

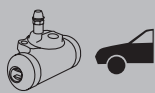

Brake Wheel Cylinder Front

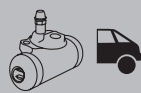

Brake Wheel Cylinder Rear Left

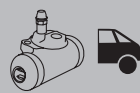

Brake Wheel Cylinder Rear Right

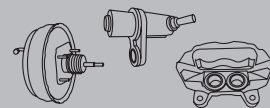

Other Parts

		A: AE-OP01	A: AE-OP01	
		A: AE-OP02	A: AE-OP02	
		A: AE-OP01	A: AE-OP01	
		A: AE-OP01	A: AE-OP01	
		A: AE-OP02	A: AE-OP02	
		A: AE-OP02	A: AE-OP02	
		A: AE-OP02	A: AE-OP02	
		A: AE-OP02	A: AE-OP02	
		A: AE-OP02	A: AE-OP02	
		A: AE-OP02	A: AE-OP02	
		A: AE-OP02	A: AE-OP02	
		A: AE-OP02	A: AE-OP02	
		A: AE-OP02	A: AE-OP02	
		A: AE-OP02	A: AE-OP02	
		A: AE-OP02	A: AE-OP02	
		A: AE-OP01	A: AE-OP01	
		A: AE-OP01	A: AE-OP01	
		A: AE-OP01	A: AE-OP01	
		A: AE-OP01	A: AE-OP01	
		A: AE-OP01	A: AE-OP01	
		A: AE-OP01	A: AE-OP01	
		A: AE-OP02	A: AE-OP02	
		A: AE-OP02	A: AE-OP02	
		A: AE-OP02	A: AE-OP02	
		A: AE-OP02	A: AE-OP02	
		A: AE-OP02	A: AE-OP02	
		A: AE-OP02	A: AE-OP02	
		A: AG-001	A: AG-001	
		A: AG-001	A: AG-001	
		A: AE-OP01	A: AE-OP01	
		A: AE-OP01	A: AE-OP01	
		A: AE-OP01	A: AE-OP01	
		A: AE-OP01	A: AE-OP01	
		A: AE-OP01	A: AE-OP01	
		A: AE-OP01	A: AE-OP01	

APPLICATION LIST



CCM

Body Type



Brake Code



Brake Pads Front



Brake Pads Rear

# OPEL

APPLICATION LIST

KADETT E	1984.09		16D/ 16DA	1598	Type E to E/G nr 14310804	D	ATE/GM		
	1986.01	1989.12	16DA	1598	38, 48, 39, 49	D			
	1984.09	1986.08	16SH	1598	Type E	G	ATE/GM		
	1986.09	1991.08	16SV	1598	33, 34, 43, 44, 35, 36, 45, 46, 43B	G			
	1986.09	1991.08	16SV	1598	39, 49	G			
	1986.09	1991.08	C16LZ/ C16NZ	1598	35, 36, 45, 46, 43B	G			
	1986.09	1991.08	C16LZ/ C16NZ	1598	39, 49	G			
	1986.09	1991.08	C16LZ/ C16NZ/ E16NZ	1598	33, 34, 43, 44	G			
	1986.09	1991.08	E16NZ, C16LZ, C16NZ, 16SV	1598	39, 49, 35, 36, 45, 46, 43B	G			
	1989.02	1991.08	17D	1700	33, 34, 43, 44, 35, 36, 45, 46, 37, 47	D			
	1989.07		17D	1700	Type E	D	ATE/GM		
	1989.01	1994.07	17D/DR	1700	38, 48	D			
	1984.09		18SE	1796	GSI fr E/G nr 14348331	G	GM		
	1985.06		18SE/ C18NT/ C18NZ	1796	fr E/G nr 14348331	G	GM		
1986.08		E18NV/ S18NS	1796		G	GM			
MOVANO	2000.09		F9Q770	1870	F9/ J9	D			
	2000.09		G9T720	2188	F9	D			
	2000.09		G9T720	2188	F9/H9/U9/E9	D			
	2000.09		G9T720	2188	H9	D			
	2000.09		G9T720	2188	J9	D			
	2000.09		G9T720	2188	U9, E9	D			
	2001.10		G9U720	2463	F9, J9, U9, E9	D			
VECTRA A	1988.09	1993.05	16SV	1598	86, 87, 88, 89	G			
	1988.09	1995.11	C16NZ, C16NZ2	1598	86, 87, 88, 89	G			
	1988.09	1990.10	E16NZ	1598	86, 87, 88, 89	G			
	1993.09	1995.11	X16SZ	1598	86, 87, 88, 89	G			
	1988.06	1992.09	17D	1700	86, 87, 88, 89	D			
	1992.07	1995.11	17DR	1700	86, 87, 88, 89	D			
	1988.09	1990.10	18SV	1796	chss nr K, N	G	GM		
	1990.03	1995.11	C18NZ	1796	nr N	G	GM		
	1989.01	1989.07	E18NVR	1796	chss nr P	G			
VIVARO	2001.08		F9	1870	DI 80HP	D			
	2001.08		F9Q760	1870	TDI 102HP	D			
	2001.08		F4R720/2	1998	120HP	G			





CCM

Body Type



Brake Code

Brake Pads  
FrontBrake Pads  
Rear

## PEUGEOT

405	1988.07	1992.12	DKZ (XU9JAZ)	1905	15B, 15E	G			
	1987.07	1992.12	XU92C	1905	15B, 15E	G			
406	1995.11	2004.05	XU5JP	1580	8B	G			
	1997.05	2004.05	XU7JB	1761	8B/8F	G			

## PROTON

313	1995.11		4G13	1299	C96	G	SUM	D1N014	
315	1995.11		4G15	1468	C97	G	SUM	D1N013	
413	1988.12		G13B	1299	C21	G	SUM	D1N014	
415	1988.12			1468	C22	G	SUM	D1N013	
416	1993.11	1997.12	4G92P	1597	C98	G	SUM/AKE		D2N040
418	1996.05		4G93	1834	C99	G	SUM	D1N035	
420D	1996.05	1998.12	4D68	1998	C95	D	SUM	D1N013	
420TD	1996.09		4D68	1992	C95 T	D	SUM	D1N013	
PERSONA COMPACT	1996.09		4G13	1299	C96M	G			

## RENAULT

MASTER	2001.10		G9U	2463	JD, ND Dci 115HP	D			
MASTER II	2000.09		F9Q770/ 72	1870	FD, JD, ND	D			
	2000.09		G9T722	2188	FD, JD, ND, ED, HD, UD 90HP	D			
TRAFIC	2001.03		F9	1870	FL, JL DCI 80HP	D			
	2001.03		F9Q760	1870	FL, JL DCI 102HP	D			
	2001.03		F4R720/2	1998	FL0A, JL0A	G			

## ROVER

213S/SE	1984.06	1989.12	EV2	1342	XH	G	SUM		
214	1993.09	1995.10	14K2A/D	1396	XW	G			
	1989.10	1995.10	14K4	1396	XW	G			
	1990.01	1995.10	14K4C/D	1396	XW	G			
	1992.12	1995.10	14K4F	1396	XW	G			
216SI/GSI	1989.10	1995.12	D16	1590	XW	G	LUC/ AKE+ABS		C2N022
220 Diesel Turbo	1995.11	1999.11	20T2N	1994	RF SDi T	D	LUC-ABS		
	1995.11	1999.11	20T2R	1994	RF SD T	D	LUC/ AKE+ABS		C2N022
414	1990.04	1995.04	14K4C/D	1396	XW	G			
	1993.01	1995.04	14K4F	1396	XW	G			
416SI/GSI	1989.10	1996.02	D16	1590	XL	G	LUC/ AKE+ABS		C2N022



Brake Master Cylinder

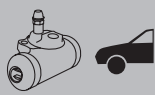

Brake Wheel Cylinder Front

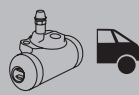

Brake Wheel Cylinder Rear Left

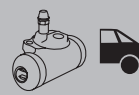

Brake Wheel Cylinder Rear Right

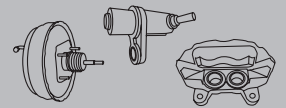

Other Parts

BMT-061				
BMT-061				
ME-CI01				
ME-CI01				

		A: AM-005	A: AM-005	
		A: AM-005	A: AM-005	
		A: AM-005	A: AM-005	
		A: AM-005	A: AM-005	

MN-138				
MN-138				
MN-138				
MN-133				
MN-133				
MN-133				

		A: AH-002L	A: AH-002R	
		A: AH-019L	A: AH-019R	
		A: AH-019L	A: AH-019R	
MO-004		A: AH-019L	A: AH-019R	
		A: AH-019L	A: AH-019R	
		A: AH-019L	A: AH-019R	
		A: AE-RO02L	A: AE-RO02R	
		A: AE-RO02L	A: AE-RO02R	
		A: AH-019L	A: AH-019R	
		A: AH-019L	A: AH-019R	

APPLICATION LIST



CCM

Body Type



Brake Code



Brake Pads Front



Brake Pads Rear

# ROVER

420Diesel turbo	1995.11		20T2N	1994	RT SDi T	D	LUC/ AKE+ABS		C2N022
	1995.11		20T2R	1994	SD T	D	LUC-ABS		
620	1993.04	1999.06	F20Z1	1997	RH	G	AKE/ AKE+AUTO		
620D	1994.05	1996.02	20T2N	1994	RH T	D	AKE/AKE		
	1996.02	1999.06	20T2N	1994	RH T	D	AKE/AKE		
623	1993.04	1999.06	H23A3	2259	RH	G	AKE/AKE	C1N018	

# SAO

PENZA	1991.06	1994.12	B3	1323	XP	G	SUM	E1N014	
-------	---------	---------	----	------	----	---	-----	--------	--

# SUBARU

E12	1986.06	1991.07	EF12	1189	KJ8 2WD	G	SUM		
	1986.06	1991.07	EF12	1189	KJ8 4WD	G	SUM		
FORESTER	1997.09	1998.02	EJ20	1994	SF5	G	AKE	F1N013	F2N015
	1998.03		EJ20	1994	SF5	G	AKE/AKE	F1N013	F2N015
	2002.02	2004.12	EJ20	1994	SG5	G	AKE	F1N013	
	2008		EJ20	1994	SH5	G		F1N018	
	1997.09	2002.01	EJ20T	1994	SF5	G	AKE	F1N013	F2N015
	2002.02	2004.01	EJ20T	1994	SG5 T	G	AKE	F1N013	
IMPREZA	1992.11	1994.08	EJ16	1597	GC3B, GF3B 2WD	G	SUM	F1N010	
	1992.11	1994.08	EJ16	1597	GC4, GF4 4WD	G	SUM	F1N010	
	1994.08	1996.08	EJ16	1597	GC4, GF4 4WD	G	SUM/SUM	F1N010	F2N012
	1996.08	2000.12	EJ16	1597	GC4, GF4 4WD	G	SUM	F1N014	
	1998.09	2000.09	EJ161	1597	GC	G			
	2000.10	2005	EJ161	1597	GG2	G	AKE	F1N013	F2N012
	1994.08	1996.08	EJ16E	1597	GC3C, GF3C 2WD	G	SUM/SUM	F1N010	F2N012
	1996.08	2001	EJ16E	1597	GC3C, GF3C 2WD	G	SUM	F1N014	
	1992.11	1994.08	EJ18	1820	GC5, GF5 2WD	G	SUM	F1N010	
	1992.11	1993.05	EJ18	1820	GC6, GF6 4WD	G	SUM	F1N010	F2N012
	1993.06	1996.06	EJ18	1820	GC6, GF6 4WD	G	SUM/SUM	F1N010	F2N012
	2005			1994	118Kw	G			
	1995.11	1996.07	EJ20	1994	GC8, GF8 4WD	G	SUM	F1N011	F2N012
	1996.07	2000.07	EJ20	1994	GC8, GF8 4WD	G	SUM	F1N013	F2N012
	1996.08	2001	EJ20	1994	GC8, GF8 GT T	G	SUM	F1N013	F2N012
	2002.06	2005/08	EJ20	1994	GD, GG	G	BREM		
2000.10	2005	EJ201	1994	GG9	G	AKE	F1N013	F2N012	
1996.08	2000.07	EJ205/ EJ20G	1994	GC8, GF8 4WD T	G	SUM	F1N013	F2N012	
1992.11	1996.06	EJ20T	1994	GC8, GF8 4WD T	G	SUM	F1N011	F2N012	
2008		EJ25	2457	GRF - WRX -	G		F1N019		
JUSTY	1984.02	1996	EF10	997	KA5, KD5 2WD	G	AKE		
	1984.02	1996	EF10	997	KA6, KD6 4WD	G	AKE		
	1985.10	1994.03	EF12	1189	KA8, KD8 4WD	G	AKE		





Brake Master Cylinder



Brake Wheel Cylinder Front

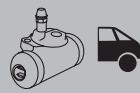

Brake Wheel Cylinder Rear Left

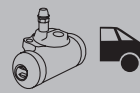

Brake Wheel Cylinder Rear Right

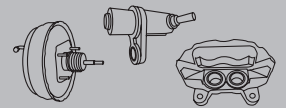

Other Parts

		A: AH-019L	A: AH-019R	
		A: AH-019L	A: AH-019R	
MH-044				
MH-044				
MH-044				
MH-044				

APPLICATION LIST

--	--	--	--	--

		A: AF-001	A: AF-001	
		A: AF-001	A: AF-001	
MF-014		A: AF-010	A: AF-010	
MF-014		A: AF-010	A: AF-010	
MF-014		A: AF-010	A: AF-010	
MF-014				
MF-014				
MF-900				
MF-900				
MF-900				
MF-900				
MF-900		A: AF-009	A: AF-009	
MF-900				
MF-900				
MF-011		A: AF-010	A: AF-010	
MF-011		A: AF-010	A: AF-010	
MF-011		A: AF-010	A: AF-010	
MF-900				
MF-900		A: AF-010	A: AF-010	
MF-900				
MF-900				
MF-900				
MF-014				
MF-900		A: AF-010	A: AF-010	
		A: AF-008	A: AF-008	
		A: AF-008	A: AF-008	
		A: AF-001	A: AF-001	



CCM

Body Type



Brake Code



Brake Pads Front



Brake Pads Rear

# SUBARU

JUSTY	1988.11	1994.03	EF12	1189	KA7, KD7 2WD	G	AKE		
	1991.12	1996.03	EF12	1189	KA8, KD8 4WD	G	AKE		
JUSTY IV	2007.01			998		G			
LEGACY	1989.02	1994.12	EJ18	1820	BC2 2WD	G	SUM		
	1989.02	1996.06	EJ18	1820	BC3, BF3 4WD	G	SUM		F2N012
	1996.06	1998.09	EJ18	1820	BC3, BF3 4WD	G	AKE	F1N014	F2N012
	2008			1994		D		F1N019	
	1989.02	1993.09	EJ20	1994	BC4/BF4 2WD, BC5/BF5 4WD	G	SUM	F1N011	F2N012
	1998.12		EJ20	1994	BE, BH 4WD	G		F1N013	F2N012
	1989.02		EJ20T	1994	BFA 4WD T	G	SUM/SUM	F1N011	F2N012
	1989.02	1996.05	EJ22	2212	BC6/7, BJ6/7, BF6/7 4WD	G	SUM/SUM		F2N012
	1996.06	1998.09	EJ22	2212	BC6/7, BJ6/7, BF6/7 4WD	G	AKE/SUM	F1N014	F2N012
	1996.10	1998.09	EJ25	2457	BD9, BG9	G	AKE/SUM	F1N013	F2N012
	1998.10		EJ25	2457	BE, BH 4WD	G		F1N013	
	1998.10		EJ241	2500		G			
	2003.09		EZ30	3000	BPE	G		F1N019	F2N015
SAMBAR VAN	1996			685		G		F1N003	
SVX	1992.01	1997	EG33	3318	CXW	G	SUM/SUM		F2N012
VIVIO	1992.03	1998.09	EN07	658	KK3 2WD	G			
	1992.11	1995.02	EN07	658	KK4, KW4 4WD	G			

# SUZUKI

ALTO	1984	1988.12	F8B	796	SB308	G	SUM		
	1993.11	1997	G10	993	SH410/HCJ73/HCN73	G	SUM		
	1997.01	2002	G10B	993	FB11/MA3	G	SUM		
BALENO	1995.04	1999.01	G13BB	1298	SY413, GA11, GC11	G		H1N016	
	1999.02		G13BB	1298	SY413, GA11, GC11	G			
	1995.01	2002.05	G15	1493	SY415, GC21	G		H1N016	
	1995.04	2002.05	G16	1590	SY416, GC41	G	SUM	H1N016	
	1996.03	1999.02	J18	1839	SY418, GA31, GC31	G	SUM	H1N016	G2N010
	1999.02		J18	1839	SY418, GA31, GC31	G	SUM		G2N010
	1998.04	2002.05	XUD9	1905		D		H1N016	
1998.04	2002.05	XUD9	1905		D	Opt		G2N010	
CARRY	1979.04	1986	F8A	796	ST80/90, ST308, SK408	G			
	1985.03	1992.07	F10A	970	SK410	G	SUM		
	1985.03	1992	F10A	970	ST100	G			
	1999.02	2002		1300	GA413	G	SUM	H1N006	
GRAN VITARA	2009.01		J24B	2393		G			
GRAND VITARA	1998.08		G16B	1590	TA02, SQ416	G		H1N001	
	2005.10		F9Q	1870	JB419/420 DDiS	D			
	1998.01		J20A	1995	TD52, SQ420	G		H1N001	



Brake Master Cylinder

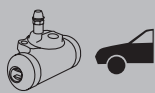

Brake Wheel Cylinder Front

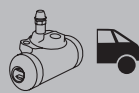

Brake Wheel Cylinder Rear Left



Brake Wheel Cylinder Rear Right

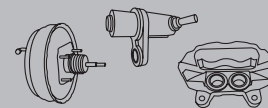

Other Parts

		A: AF-001	A: AF-001	
		A: AF-001	A: AF-001	
MN-138				
		A: AF-009	A: AF-009	
MF-012		A: AF-009	A: AF-009	
MF-012		A: AF-009	A: AF-009	
MF-012		A: AF-009	A: AF-009	
MF-014				
MF-005				
MF-005				
MF-014		A: AF-009	A: AF-009	
MF-014				
MF-014				
		A: AF-008	A: AF-008	
		A: AF-008	A: AF-008	

MS-010		A: AS-008	A: AS-008	
		A: AS-027L	A: AS-027R	
		A: AS-027L	A: AS-027R	
		A: AS-022L	A: AS-022R	
		A: AS-022L	A: AS-022R	
		A: AS-022L	A: AS-022R	
MS-012	LA: AS-003L RA: AS-003R	A: AS-020L	A: AS-020R	
MS-005	LA: AS-010LU RA: AS-010RU	A: AS-029L	A: AS-029R	
MS-005	LA: AS-010LU RA: AS-010RU	A: AS-029L	A: AS-029R	
BMT-007				
		A: AS-031L	A: AS-031R	
		A: AS-031L	A: AS-031R	
MS-032		A: AS-031L	A: AS-031R	

APPLICATION LIST



CCM

Body Type



Brake Code

Brake Pads  
FrontBrake Pads  
Rear

# SUZUKI

Model	Year 1	Year 2	CCM	Year	Body Type	Brake Code	Brake Pads Front	Brake Pads Rear
GRAND VITARA	2001.07		TW10	1997	FT, GT HDI	D	H1N001	
	1998.01	2001.01	RFM	1998	SQ420WD T	D	H1N001	
	1998.01	2003	H25	2493	TD62, SQ625 V6	G	H1N001	
IGNIS	2000.07	2003.09	M13A	1328	HT51	G	G1N006	
JIMNY	1998.09	2001.03	G13	1298	JB33	G	SUM/AKE	H1N011
SAMOURAI	1982.08	1984.12	F10A	970	SJ410 to chss nr 585000/505000	G		
	1985.01	1987.02	F10A	970	SJ410 fr. chss nr 585001/505001	G		H1N011
	1987.03	1990	F10A	970	SJ410 made in Spain	G	LUC	
	1984.05	1988.12	G13A	1324	SJ413	G	AKE	H1N011
	1998.11		XUD9	1905	T	D		
SWIFT	1986.06	1988.09	G10	993	AA43S, AB43S	G		
	1983.10	1986.05	G10A	993	AA41/43, AB41 /43, SA310	G		
	1986.06	1988.10	G13B	1298	AA33, AB33, SA413, SF413	G	AKE	
	1988.09	1992	G13B	1298	AA34, AB34, SA413, SF413 GTI	G	AKE	C2N010
	1989.10	1995.12	G13BA	1298	AA35, AB35, AH35	G	SUM	
	1991.09	1996.10	G13BA	1298	AK35 cabrio	G		
	1984.08	1986.05	G13A	1324	AA51, AB51, SA413	G	AKE	
	1986.05	1988.08	G13A	1324	AA53, AB53, SA413	G	AKE	
	1989.06		G16A	1590	AH14S, SF416	G		
	1989.06	1993.01	G16A	1590	AJ14S 4WD	G	AKE	
VITARA 3doors	1988.05	1990.08	G16A/B	1590	SA416, TA01, TB01	G	SUM	H1N004
	1995.11		G16B	1590	TV02 made in Spain	G		H1N007
	1996.06	1998.04	XUD9	1905	SF/SV T	D		
	1996.12	1999.03	J20A	1995	16V	G		
VITARA 5 doors	1990.08		G16A/B	1590	SE416, TA01R/W, TD01	G		H1N007
	1994.12	1998.03	H20A	1998	TD11, SV620 V6	G		
	1996	1998	RF	1998	TD31, SV420 T	D		
WAGON-R	1998.02	2000.05	K10A	993	MC, SR410	G		H1N020
	2003		Z13DT	1248	MA DDIS	D		
	2000.03		G13BB	1298	MA6 RB413	G		
	2003		M13A	1328	MA34S	G		H1N020
X90	1995.11	1998	G16BA	1590	SZ416, LA11S, LB11S	G	SUM	H1N004

# TOYOTA

4 RUNNER	1984.03	1988.08	22REC	2366	RN60/61	G	SUM	A1N017	
	1997.08	2000.12	2L	2446	LN165/170 T	D	SUM	A1N021	
	2000.12		2L	2446	LN165/170 T	D	SUM	A1N021	
	1989.08	1992.10	2LT	2446	LN130 T	D	SUM	A1N021	
	1992.01	1995.05	2L-T	2446	LN130 T	D			
	1995.12	2000.08	3RZFE	2693	RZN180	G	SUM	A1N029	
	1995.05	1995.11	3L	2779	LN13# T	D		A1N029	



Brake Master Cylinder



Brake Wheel Cylinder Front

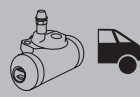

Brake Wheel Cylinder Rear Left

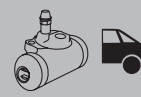

Brake Wheel Cylinder Rear Right

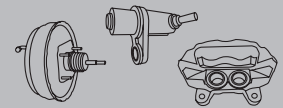

Other Parts

BMS-009		A: AS-031L	A: AS-031R	
MS-032		A: AS-031L	A: AS-031R	
BMS-009		A: AS-031L	A: AS-031R	
MS-006	LA: AS-003L RA: AS-003R	A: AS-020L	A: AS-020R	
MS-006	LA: AS-003L RA: AS-003R	A: AS-020L	A: AS-020R	
MS-030		A: AS-001L	A: AS-001R	
MS-007		A: AS-006L	A: AS-001R	
MS-031		A: WCT-005	A: WCT-005	
		A: AS-015	A: AS-015	
BMS-007		A: AS-015	A: AS-015	
		A: AS-015	A: AS-015	
MS-011		A: AS-015	A: AS-015	
MS-011		A: AS-015	A: AS-015	
BMS-007		A: AS-022L	A: AS-022R	
		A: AS-015	A: AS-015	
		A: AS-015	A: AS-015	
MS-031		A: AS-030	A: AS-030	
MS-031		A: AS-030	A: AS-030	
MS-031		A: AS-030	A: AS-030	
MS-031				
		A: AS-030	A: AS-030	
		A: AS-031L	A: AS-031R	
MS-031		A: AS-030	A: AS-030	
		A: AS-026	A: AS-025	
		A: AS-026	A: AS-025	
MS-042				
MS-042				

BMT-013				
BMT-048		A: WCT-007	A: WCT-007	
BMT-048		A: WCT-007	A: WCT-007	
BMT-035				

APPLICATION LIST



CCM

Body Type



Brake Code



Brake Pads Front



Brake Pads Rear

# TOYOTA

APPLICATION LIST

4 RUNNER	1989.08	1992.04	3VZE	2959	VZN130	G	SUM	A1N021	
	1992.04	1995.11	3VZE	2959	VZN130	G	SUM	A1N021	
	1993.10	1996.03	1KZT	2982	KZN13# T	D	SUM	A1N021	
	1995.12	2002	5VZFE	3378	VZN185 for NATO	G	SUM	A1N029	
AURIS	2006.10				E15#			A1N128	
AVENSIS	1997.10	1998.12	4AFE	1587	AT22#	G	ATE		
	1998.12	2000.10	4AFE	1587	AT22#	G	ATE		
	2000.07	2003.02	3ZZ-FE	1598	T22 VVT-I	G			
	2003		3ZZ-FE	1598	ZZT25#	G			
	2003.07		3ZZ-FE	1598	ZZT220-VVTI	G			
	1997.10	1998.12	7AFE	1762	AT22#	G	ATE		
	1998.12	2000	7AFE	1762	AT22#	G	ATE		
	2000.07	2002	1ZZ-FE	1794	ZZT221 VVT-I	G			
	2003		1ZZ-FE	1794	ZZT25#	G			
	1997.10	1998.12	2CTE	1974	CT220 T	D	ATE		
	1998.12	2000.07	2CTE	1974	CT220 T	D	ATE		
	1999.08	2002.12	1CD-FTV	1995	CDT220 DI D4D 81Kw	D	ATE		
	2003.04	2009	1CD-FTV	1995	CDT25# 85Kw	D			
	2006.03		1AD-FTV	1998	ADT25# 93Kw	D			
	2000.10	2003.04	1AZ-FSE	1998	D4 VVT-I	G		A1N068	
	2003.04		1AZ-FSE	1998	AZT25#	G			
	1997.10	1998.12	3S	1998	ST220	G	ATE		
1998.12	2000.07	3S	1998	ST220	G	ATE			
2000.07	2003.01	3S	1998	ST220	G	ATE			
2005.08	2007.05	2AD-FTV	2231	ADT25# D4D - 110Kw	D				
2003.09		2AZ-FSE	2362	T25#	G				
AVENSIS VERSO	2001.05		1CD-FTV	1995	CLM20	D		A1N105	
	2001.05		2AZ-FE	1998	ACM20	G		A1N105	
CAMRY	1982.03	1986.12	1S	1832	SV10	G	AKE	A1N034	
	1986.08	1991	1S	1832	SV20	G	AKE		
	1982.08	1985.08	1C-TL	1839	CV10 T	D	AKE	A1N034	
	1985.08	1986.08	2CTL	1974	CV11 T	D	AKE	A1N034	
	1982.08	1986.08	2S	1995	SV11	G	AKE	A1N034	
	1987.10	1991	3S-FE	1996	SV25 4WD	G	SUM/AKE	A1N038	A2N095
	1990.05	1991.06	2C	1998	CV20 T	D	AKE		
	1986.08	1988.08	2CT	1998	CV20 T	D	AKE	A1N038	
	1988.08	1990.05	2CT	1998	CV20 T	D	AKE		
	1984.06	1986.08	3S	1998	SV12	G	AKE	A1N097	A2N095
	1986.08	1988.08	3S-FE	1998	SV21	G	SUM/AKE	A1N038	A2N095
	1988.09	1991	3S-FE	1998	SV21	G	AKE/AKE	A1N038	A2N095
	1991.06	1996.08	5SF-E	2164	SXV10	G	SUM/AKE	A1N048	A2N095
	1996.08		5SF-E	2164	SXV20	G	SUM/AKE	A1N048	A2N095
	2001.09	2003.07	2AZ-FE	2362	ACV30	G		A1N073	A2N104
	2003.07		2AZ-FE	2362	ACV30	G		A1N073	A2N104
	2006.01		2AZ-FE	2362	ACV40 VVTi 4cyl	G		A1N154	A2N130
1988.02	1991	2VZ	2507	VZV 21 V6	G	AKE/AKE	A1N038	A2N095	



Brake Master Cylinder

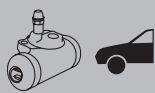

Brake Wheel Cylinder Front

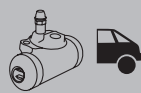

Brake Wheel Cylinder Rear Left

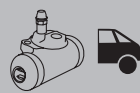

Brake Wheel Cylinder Rear Right

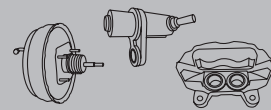

Other Parts

BMT-048		A: WCT-027	A: WCT-027	
BMT-048		A: WCT-027	A: WCT-027	
BMT-048		A: WCT-027	A: WCT-027	
BMT-035				
MT-900		A: AT-047L	A: AT-047R	
MT-900		A: AT-047L	A: AT-047R	
MT-900		A: AT-047L	A: AT-047R	
MT-903		A: AT-047L	A: AT-047R	
MT-903		A: AT-047L	A: AT-047R	
MT-900		A: AT-047L	A: AT-047R	
MT-900		A: AT-047L	A: AT-047R	
MT-900		A: AT-047L	A: AT-047R	
MT-902				
MT-900		A: AT-047L	A: AT-047R	
MT-900		A: AT-047L	A: AT-047R	
		A: AT-047L	A: AT-047R	
MT-902				
MT-902				
MT-900		A: AT-047L	A: AT-047R	
MT-900				
MT-900		A: AT-047L	A: AT-047R	
MT-900		A: AT-047L	A: AT-047R	
		A: AT-047L	A: AT-047R	
MT-902				
MT-902				
				BC LR: A5L011 BC RR: A5R011
		A: WCT-009	A: WCT-012	
BMT-010		A: WCT-009	A: WCT-012	ABS FRL: AST-001
		A: WCT-009	A: WCT-012	
		A: WCT-009	A: WCT-012	
		A: WCT-018	A: WCT-021	ABS FRL: AST-001
BMT-010		A: WCT-009	A: WCT-012	
BMT-010		A: WCT-009	A: WCT-012	
BMT-010		A: WCT-009	A: WCT-012	
		A: WCT-009	A: WCT-012	ABS FRL: AST-001
		A: WCT-018	A: WCT-021	ABS FRL: AST-001
BMT-281		A: WCT-036	A: WCT-038	
BMT-039		A: WCT-036	A: WCT-038	
				BC LR: A5L020 BC RR: A5R020
BMT-010		A: WCT-018	A: WCT-021	ABS FRL: AST-001

APPLICATION LIST



CCM

Body Type



Brake Code



Brake Pads Front



Brake Pads Rear

# TOYOTA

APPLICATION LIST

CAMRY				2959		G	AKE	A1N097	A2N081
	1996.08		1MZFE	2995	MCV20 V6	G	AKE	A1N097	A2N081
	2000.08	2001.07	1MZFE	2995	MCV20 V6 JPN PROD	G	AKE	A1N097	A2N081
	1991.06	1994	3VZFE	2995	VCV10 V6	G	SUM/AKE	A1N041	A2N095
	1995	1996.08	3VZFE	2995	VCV10 V6	G	SUM/AKE	A1N041	A2N095
	2007		2GR-FE	3456	GSV40 - V6	G			
CARINA	1970.12	1977.07	2T	1588	TA12/14	G	AKE		
	1977.08	1980.08	2T	1588	TA40/45	G	AKE		
	1980.08	1983.09	2T	1588	TA45	G	AKE		
	1980.08	1983.09	2T	1588	TA60/61/67	G	AKE		
	1982.02	1985.08	1C	1839	CA60, 67	D	AKE		
CARINA II	1983.10	1987.12	4A	1587	AT151 FWD	G	AKE	A1N034	
	1987.12	1992.08	4A	1587	AT170, 171	G	AKE	A1N034	
	1989.11	1992.08	4A	1587	AT170, 171 EFI	G	AKE	A1N034	
	1984.05	1987.12	1S	1832	ST150/160 FWD	G	AKE	A1N034	
	1987.12	1992	2C	1974	CT170, 176, 177	D	AKE	A1N034	
	1983.10	1984.11	2C-L	1974	CT150 FWD	D	AKE	A1N034	
	1984.12	1987.12	2C-L	1974	CT150 FWD	D	AKE	A1N034	
	1987.12	1992.03	3S	1998	ST171	G	AKE/AKE	A1N038	A2N095
CARINA E	1992.02	1996.08	4AFE	1587	AT190	G	SUM-ABS	A1N048	
	1996.08	1997.10	4AFE	1587	AT190	G	SUM-ABS	A1N048	
	1995	1996.08	7A.FE	1762	AT19# lean burn	G	SUM-ABS	A1N048	A2N094
	1996.08	1997.10	7A.FE	1762	AT19# lean burn	G	SUM-ABS	A1N048	
	1992.02	1996.01	2C	1974	CT190 Jpn prod.	D	SUM/AKE+ABS	A1N048	A2N081
	1994.10	1996.08	2C	1974	CT190 UK prod.	D	SUM-ABS	A1N048	
	1996.08	1997.10	2C	1974	CT190 UK prod.	D	SUM-ABS	A1N048	
	1996.08	1997.10	2CT	1974	CT190 UK prod. T	D	SUM/AKE+ABS	A1N048	A2N081
	1992.02	1997.10	3S-FE	1998	ST191 XLI, GLI	G	SUM-ABS	A1N048	A2N094
	1992.02	1996.08	3S-GE	1998	ST191 GTI	G	AKE-ABS	A1N048	A2N094
	1996.08	1997.10	3S-GE	1998	ST191 GTI	G	AKE-ABS	A1N053	A2N095
CELICA	1985.08	1989.09	4A	1587	AT160	G	AKE	A1N034	
	1989.10	1991.05	4AFE	1587	AT180	G	AKE	A1N034	
	1991.08	1993.10	4AFE	1587	AT180	G	AKE		
	1977.08	1980.08	2T	1588	TA40/45/55	G	AKE		
	1980.08	1981.07	2T	1588	TA40/45/55	G	AKE		
	1981.08	1983.08	2T	1588	TA60/61	G	AKE		
	1993.11	1999	7AFE	1762	AT200	G	SUM/AKE-ABS	A1N048	A2N095
	1999.08	2005.09	1ZZ-FE	1794	ZZT230 105Kw VVT-I	G	SUM/AKE	A1N068	A2N007
	1999.08	2002.08	2ZZ-GE	1796	ZZT231 141Kw VVTL-I	G	AKE	A1N065	A2N007
	1981.08	1983.08	21R	1972	RA46/60/61	G	AKE		
	1987.08	1991.01		1998	ST161	G			A2N081
	1989.10	1990.05	3S-GE	1998	ST182	G	AKE/AKE+CH	A1N038	A2N081
	1990.05	1993.11	3S-GE	1998	ST182	G	AKE-CH		A2N027





Brake Master Cylinder

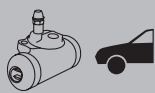

Brake Wheel Cylinder Front

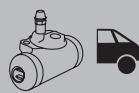

Brake Wheel Cylinder Rear Left



Brake Wheel Cylinder Rear Right

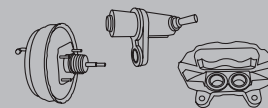

Other Parts

BMT-281		A: WCT-073	A: WCT-071	
BMT-281		A: WCT-036	A: WCT-038	
BMT-281				
BMT-281		A: WCT-036	A: WCT-038	
				BC FL: A5L008 BC FR: A5R008
		A: WCT-010	A: WCT-010	
		A: WCT-010	A: WCT-010	
		A: WCT-010	A: WCT-010	
		A: WCT-010	A: WCT-010	
		A: WCT-010	A: WCT-010	
		A: WCT-002	A: WCT-001	
		A: WCT-009	A: WCT-012	BB: BBT-056
		A: WCT-009	A: WCT-012	
		A: WCT-002	A: WCT-001	
BMT-086		A: WCT-002	A: WCT-001	
		A: WCT-002	A: WCT-001	
		A: WCT-009	A: WCT-012	
BMT-049		A: WCT-015	A: WCT-014	
		A: WCT-015	A: WCT-014	
BMT-049		A: WCT-015	A: WCT-014	
BMT-133		A: WCT-015	A: WCT-014	
BMT-049		A: WCT-015	A: WCT-014	
BMT-049		A: WCT-015	A: WCT-014	
		A: WCT-015	A: WCT-014	
BMT-133		A: WCT-015	A: WCT-014	
BMT-049		A: WCT-015	A: WCT-014	
MT-205		A: WCT-015	A: WCT-014	
		A: WCT-015	A: WCT-014	
		A: WCT-009	A: WCT-012	
BMT-088		A: WCT-122	A: WCT-105	
BMT-088		A: WCT-122	A: WCT-105	
		A: WCT-010	A: WCT-010	
		A: WCT-010	A: WCT-010	
		A: WCT-010	A: WCT-010	
BMT-132		A: WCT-015	A: WCT-014	
		A: WCT-015	A: WCT-014	BC FL: ET-073L BC FR: ET-073R
				BC FL: A5L012 BC FR: A5R012
		A: WCT-006	A: WCT-006	
BMT-088				
BMT-088				

APPLICATION LIST



CCM

Body Type



Brake Code



Brake Pads Front



Brake Pads Rear

# TOYOTA

APPLICATION LIST

CELICA	1993.11	1999	3S-GE	1998	ST202	G	SUM/AKE	A1N041	A2N094
	1993.11	1995.08	3S-GE	1998	ST202 SSS	G	SUM/AKE	A1N041	A2N094
	1994.02	1996.06	3S-GE	1998	ST205 4WD T	G	SUM/AKE	A1N028	A2N027
	1985.08	1989.09	3SGEL	1998	ST162	G	AKE	A1N034	A2N081
	1986.10	1991.10	3SGTE	1998	ST165 GT 4WD T	G	SUM/AKE	A1N038	A2N095
	1989.10	1991.08	3SGTE	1998	ST185 4WD T	G	AKE/ AKE+ABS LHD-CH	A1N038	A2N081
	1991.08	1994	3SGTE	1998	ST185 4WD T	G	SUM/AKE	A1N038	A2N027
COASTER	1989.10	1993.01	3B	3431	BB21	D			
	1993.01	2000.04	3B	3431	BB4#	D		A1N060	
	1988.08	1989.10	14B	3660	BB23, 32	D		A1N061	
	1989.10	1993.01	14B	3660	BB23, 32	D		A1N061	
	1986.10	1989.10	..2H-T	3980	HB31	D			
	1989.10	1990.01	..2H-T	3980	HB31	D			
	1986.10	1989.10	2H	3980	HB30	D			
	1990.01	1993.01	1HD-T	4164	HDB30, 31	D			
	1990.01	1993.01	1HZ	4164	HZB30	D		A1N061	
	1993.01		1HZ	4164	HZB40/41/56	D		A1N100	
	1993.01	1999.07	1HZ	4164	HZB50	D		A1N100	
1999.07		1HZ	4164	HZB50	D		A1N100		
COROLLA	1974.04	1979.08	3K	1166	KE20/5, 30/35/40/45/ 50/60	G			
	1979.08	1983.06	4K	1290	KE70, KE72, KE73 RWD	G	AKE		
	1983.05	1985.05	2A	1295	AE80 FWD	G	AKE	A1N034	
	1985.05	1985.12	2E	1295	EE80	G	AKE	A1N034	
	1985.12	1987.04	2E	1295	EE80	G	AKE	A1N034	
	1987.05	1989.05	2E	1295	EE90, 96V, 97G	G	AKE	A1N034	
	1989.05	1992.12	2E	1295	EE90, 96V, 97G	G	AKE	A1N034	
	1992.05	1994.08	4E	1332	EE100/101	G	SUM	A1N034	
	1994.08	1996.11	4E	1332	EE100/101	G	SUM	A1N034	
	1996.11	1997.04	4E	1332	EE100/101	G	SUM	A1N034	
	1997.04	2001	4E-FE	1332	EE111	G	SUM	A1N034	
	2004.08	2006	1ND-TV	1364	NDE12J/E12U D4D	D			
	2006.11		1ND-TV	1364	NDE150 D4D - japan	D			
2000.02	2002.01	4ZZ-FE	1398	ZZE111	G		A1N034		



Brake Master Cylinder



Brake Wheel Cylinder Front

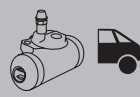

Brake Wheel Cylinder Rear Left

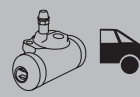

Brake Wheel Cylinder Rear Right

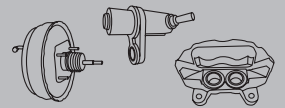

Other Parts

BMT-131				
BMT-131				
MT-007				
BMT-088				
BMT-088				
	LA: WCT-095 LB: WCT-099 RA: WCT-085 RB: WCT-089			BB: BBT-030
BMT-104	LA: WCT-055 LB: WCT-042 RA: WCT-041 RB: WCT-059			
				BB: BBT-030
				BB: BBT-030
	LA: WCT-095 LB: WCT-099 RA: WCT-085 RB: WCT-089			
	LA: WCT-095 LB: WCT-099 RA: WCT-085 RB: WCT-089			
				BB: BBT-030
		A: WCT-128 B: WCT-149	A: WCT-116 B: WCT-148	
	LA: WCT-095 LB: WCT-099 RA: WCT-085 RB: WCT-089			
BMT-142		A: WCT-045 B: WCT-066	A: WCT-058 B: WCT-065	
BMT-216				
BMT-065		A: WCT-006	A: WCT-006	
BMT-240		A: WCT-006	A: WCT-006	
		A: WCT-002	A: WCT-001	
		A: WCT-002	A: WCT-001	
		A: WCT-002	A: WCT-001	
BMT-173		A: WCT-002	A: WCT-001	
BMT-173		A: WCT-002	A: WCT-001	
MT-005		A: WCT-026	A: WCT-022	
MT-005		A: WCT-015	A: WCT-014	
MT-005		A: WCT-015	A: WCT-014	
BMT-120		A: WCT-026	A: WCT-022	
MT-203				
BMT-061				
BMT-267		A: WCT-015	A: WCT-014	

APPLICATION LIST



CCM

Body Type



Brake Code



Brake Pads Front



Brake Pads Rear

# TOYOTA

APPLICATION LIST

COROLLA	2002		4ZZ-FE	1398	ZZE120	G			
	1987.05	1992.05	4A	1587	AE92 except GTI	G	AKE	A1N034	
	1992.05	1997.04	4A	1587	AE101	G	SUM	A1N034	A2N095
	1992.05	1997.04	4A	1587	AE101 w/ ABS	G		A1N034	A2N095
	1992.05	1997	4A	1587	AE103 4WD	G			
	1992.05	1997	4A	1587	AE103 4WD w/ ABS	G			
	1995.08	1997.04	4A	1587	AE103 4WD	G			
	1995.08	1997.04	4A	1587	AE103 4WD w/ ABS	G			
	1997.04	2001.01	4A	1587	AE111 Japan prod.	G	LUC	A1N034	A2N075
	1997.04	2001	4A	1587	AE115	G		A1N034	
	1998.09	2001.01	4A	1587	AE111 UK prod	G	AKE	A1N034	A2N075
	1983.05	1987.04	4A-EGLU	1587	AE86 CPE GT / RWD	G	AKE/SUM		A2N076
	1984.10	1987.04	4A-EGLU	1587	AE82 HBK GTI 16V	G	AKE	A1N034	
	1983.05	1985.04	4A-ELU	1587	AE82, AE86 except GTI	G			
	1985.05	1987.04	4A-ELU	1587	AE82, AE86 except GTI	G			
	1987.10	1991.06	4AF	1587	AE95 4WD ESCAPE	G	AKE	A1N034	
	1989.11	1992	4AF	1587	AE92 except GTI	G	AKE	A1N034	
	1987.05	1989.10	4AGE	1587	AE92 HBK GTI	G	AKE	A1N034	
	1989.11	1992	4AGE	1587	AE92 GTI	G	AKE	A1N034	A2N075
	1978.05	1983.05	2T	1588	TE55/65/71 Corolla & Trueno	G			
	1999	2001.01	3ZZ-FE	1598	ZZE112	G		A1N034	
	2002.01	2004.06	3ZZ-FE	1598	ZZE121	G			
	1992.11	1995.05	7AFE	1762	AE102 GTI	G	AKE	A1N034	
	1992.11	1995.05	7AFE	1762	AE102 GTI w/ ABS	G		A1N034	
	2001.11		2ZZ-GE	1796	ZZE123	G		A1N065	A2N007
	2002.01		2ZZ-GE	1796	E12U	G			
	1987.05	1987.08	1C	1839	CE90	D	AKE	A1N034	
	1987.08	1992	1C	1839	CE90, 96, 97	D	AKE	A1N034	
	1983.05	1987.04	1C-L	1839	CE80 FWD	D			
	1998.12	2001.11	1WZ	1868	WZE11#	D		A1N048	
	1991.06	1997	2C	1974	CE104, 109V	D			
	1992.05	1997.04	2C	1975	CE100	D	SUM	A1N034	
	1995.05	1996.05	2C	1975	CE100 w/ABS	D		A1N034	
1997.04	2000.02	2C	1975	CE110	D	SUM	A1N048		
COROLLA VERSO	2001.10	2004.05	4ZZ-FE	1398	ZZE120	G	AKE	A1N068	A2N007
	2001.10	2004.01	3ZZ-FE	1598	ZZE121	G	AKE		A2N007
	2002.01	2004	3ZZ-FE	1598	E12J	G			
	2004		3ZZ-FE	1598	VVT-I	G	AKE		A2N007
	2001.09	2004.01	1ZZ-FE	1794	ZZE122N	G	AKE	A1N068	A2N007
	2004		1ZZ-FE	1794	E12	G	AKE	A1N068	A2N007
	2001	2004	1CD-FTV	1995	EE11/E12	D			
	2001.10	2004.01	1CD-FTV	1995	CDE120 D4D	D	AKE	A1N068	A2N007
	2004.04		1CD-FTV	1995	CUR10 D4D	D	AKE	A1N068	A2N007



Brake Master Cylinder



Brake Wheel Cylinder Front

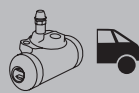

Brake Wheel Cylinder Rear Left

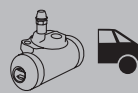

Brake Wheel Cylinder Rear Right

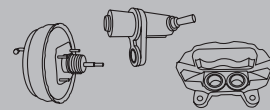

Other Parts

MT-203				
BMT-113		A: WCT-002	A: WCT-001	
BMT-017		A: WCT-026	A: WCT-022	
BMT-120		A: WCT-026	A: WCT-022	
BMT-017				
BMT-120				
BMT-017				
BMT-120				
BMT-120		A: WCT-026	A: WCT-022	
BMT-120				
BMT-120		A: WCT-026	A: WCT-022	
		A: WCT-002	A: WCT-001	
		A: WCT-002	A: WCT-001	
		A: WCT-002	A: WCT-001	
BMT-173		A: WCT-017	A: WCT-017	
BMT-024		A: WCT-002	A: WCT-001	
BMT-086		A: WCT-002	A: WCT-001	
BMT-086				
BMT-240		A: WCT-010	A: WCT-010	
		A: WCT-015	A: WCT-014	
MT-203				BC FL: A5L013 BC FR: A5R013
BMT-017		A: WCT-026	A: WCT-022	
BMT-120		A: WCT-026	A: WCT-022	
BMT-127				
MT-204				
BMT-173		A: WCT-002	A: WCT-001	
BMT-173		A: WCT-002	A: WCT-001	
BMT-113		A: WCT-002	A: WCT-001	
		A: WCT-015	A: WCT-014	
BMT-017		A: WCT-026	A: WCT-022	
MT-005		A: WCT-026	A: WCT-022	
BMT-120		A: WCT-015	A: WCT-014	
MT-106		A: WCT-026	A: WCT-022	
MT-203				BC FL: A5L012 BC FR: A5R012
MT-203				BC FL: A5L012 BC FR: A5R012
MT-903				
BMT-127		A: WCT-074	A: WCT-069	BC FL: A5L012 BC FR: A5R012
MT-903				
MT-203				BC FL: A5L012 BC FR: A5R012
MT-903				



CCM

Body Type



Brake Code



Brake Pads Front



Brake Pads Rear

# TOYOTA

APPLICATION LIST

CORONA	1992.10	1996	1GFE	1988	GX90	G		A1N048	A2N057
CRESSIDA	1976.12	1980.09	18R	1968	RX30/35	G	SUM		
	1980.09	1982.08	21R	1972	RX60	G	SUM	A1N016	
	1980.12	1984.07	1GEU	1988	GX60, 61 EFI	G	SUM	A1N016	
	1980.08	1984.07	L	2188	LX60	D			
	1980.08	1984.07	L	2188	LX67	D	SUM	A1N016	
	1984.08	1985.11	2LT	2446	LX70 T	D	AKE		
	1984.08	1986.08	5MGE	2759	MX72/73	G	AKE		
CROWN	1979.09	1983.07	5ME	2759	MS112	G	SUM		
DYNA	1987.08		2Y	1812	YH80	G		A1N036	
	1980.10	1983.11	5R-J	1994	RU2#, RU3#	G			
	1983.11	1984.09	5R-J	1994	RU22/32	G			
	1984.09	1987.08	3Y	1998	YU60/61/70/80	G		A1N049	
	1985.08	1995	3Y	1998	YY61	G			
	1987.08	1990.08	3Y	1998	YU60/61/70/80	G		A1N049	
	1987.08	1988.08	3Y	1998	YY61	G	AKE		
	1990.08	1993.09	3Y	1998	YU60/61/70/80	G		A1N049	
	1993.09	1995.05	3Y	1998	YU60/61/70/80	G		A1N049	
	1995.05	1999.05	3Y	1998	YY211	G			
	1985.08	1987.08	3Y-J	1998	YY52/61	G			
	1996.11		RZ	2438	RZH135, 153				
	1983.08	1987.08	2L	2446	LY21/31/50/60	D			
	1988.07	1988.08	2L	2446	LH80	D	AKE	A1N036	
	1988.08	1989.08	3L	2779	LY61 Europe general	D			
	1988.08	1989.08	3L	2779	LY61 for Switzerland	D			
	1989.08	1995.05	3L	2779	LY61 DRT	D			
1989.08	1995.05	3L	2779	LY61 SRT	D				
1995.05	1999.05	3L	2779	LY100	D	SUM	A1N036		
1995.05	1996.10	3L	2779	LY211	D				
1985.01	1988.08	11B	2977	BU61	D				
1985.01	1988.08	11B	2977	BU81	D				



Brake Master Cylinder



Brake Wheel Cylinder Front

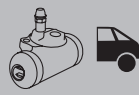

Brake Wheel Cylinder Rear Left

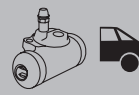

Brake Wheel Cylinder Rear Right

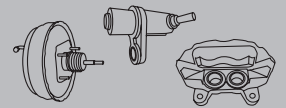

Other Parts

		A: WCT-006	A: WCT-006	
BMT-271		A: WCT-006	A: WCT-006	BB: BBT-007
		A: WCT-006	A: WCT-006	
		A: WCT-006	A: WCT-006	
				BB: BBT-005
BMT-032				
		A: WCT-013	A: WCT-013	
				BB: BBT-023
				BB: BBT-023
BMT-093	LA: WCT-137 LB: WCT-138 RA: WCT-136 RB: WCT-090	A: WCT-048	A: WCT-048	
BMT-093		A: WCT-123 B: WCT-129	A: WCT-108 B: WCT-117	
BMT-093	LA: WCT-137 LB: WCT-138 RA: WCT-136 RB: WCT-090			
BMT-093		A: WCT-123 B: WCT-129	A: WCT-108 B: WCT-117	
BMT-093	LA: WCT-137 LB: WCT-138 RA: WCT-136 RB: WCT-090	A: WCT-127 B: WCT-131	A: WCT-114 B: WCT-120	
BMT-093	LA: WCT-096 RA: WCT-086			
BMT-117		A: WCT-123	A: WCT-108 B: WCT-117	
BMT-059		A: WCT-123 B: WCT-129	A: WCT-108 B: WCT-117	
BMT-129				
BMT-059		A: WCT-123 B: WCT-129	A: WCT-108 B: WCT-117	
BMT-059		A: WCT-123 B: WCT-129	A: WCT-108 B: WCT-117	
BMT-059		A: WCT-123 B: WCT-129	A: WCT-108 B: WCT-117	
BMT-059		A: WCT-123 B: WCT-129	A: WCT-108 B: WCT-117	
BMT-059		A: WCT-123 B: WCT-129	A: WCT-108 B: WCT-117	
BMT-117				
BMT-093	LA: WCT-137 LB: WCT-138 RA: WCT-136 RB: WCT-090			
BMT-093	LA: WCT-137 LB: WCT-138 RA: WCT-136 RB: WCT-090			

APPLICATION LIST



CCM

Body Type



Brake Code



Brake Pads Front



Brake Pads Rear

# TOYOTA

APPLICATION LIST

DYNA	1988.08	1995.05	11B	2977	BU61	D		
	1988.08	1995.05	11B	2977	BU84	D		
	1984.09	1987.08	B	2977	BU6#, 7#, 8#	D		
	1986.01	1988.08	B	2977	BU60VH	D		A1N061
	1987.08	1988.08	B	2977	BU6#, 7#, 8#	D		A1N061
	1988.08	1989.10	B	2977	BU60, 70, 83, 84	D		A1N061
	1988.08	1995.05	B	2977	BU60VH	D		
	1988.08	1995.05	B	2977	BU84	D		
	1989.10	1995.05	B	2977	BU60, 70, 83, 84	D		
	1981.07	1987.08	13B	3431	BU6#, 7#, 8#, 9#	D		A1N049
	1987.08	1988.08	13B	3431	BU6#, 8#, 9#, 62 double cabin	D		
	1984.09	1988.08	13B-T	3431	BU85, 90, 95	D		A1N049
	1980.09	1987.08	3B	3431	BU2#, 3#, 4#, 5#, 62#	D		
	1989.10	1995.05	3B	3431	BU68DH	D		
	1995.05	1999.05	3B	3431	BU10#, 120V, 14#	D		
	1995.05	1999.05	3B	3431	BU10#, 120V, 14# FRONT DISC BRAKE	D		
	1989.10	1993.10	14B	3700	BU72, 78	D		
1990	1995	1W	4009	WU 75	D			
1995.05	1996.11	15B	4104	BU100, BU140	D			





Brake Master Cylinder



Brake Wheel Cylinder Front

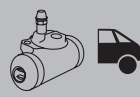

Brake Wheel Cylinder Rear Left

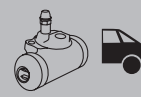

Brake Wheel Cylinder Rear Right

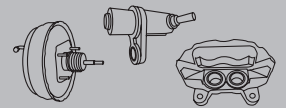

Other Parts

BMT-093				
BMT-093	LA: WCT-137 RA: WCT-136 RB: WCT-090			
BMT-093	LA: WCT-137 LB: WCT-138 RA: WCT-136 RB: WCT-090			
BMT-093	LA: WCT-137 RA: WCT-136 RB: WCT-090			
BMT-093	LA: WCT-137 LB: WCT-138 RA: WCT-136 RB: WCT-090			
BMT-093	LA: WCT-137 LB: WCT-138 RA: WCT-136 RB: WCT-090			
BMT-093	LA: WCT-137 LB: WCT-138 RA: WCT-136 RB: WCT-090			
BMT-093	LA: WCT-137 RA: WCT-136 RB: WCT-090			
BMT-093	LA: WCT-137 LB: WCT-138 RA: WCT-136 RB: WCT-090	A: WCT-127 B: WCT-131	A: WCT-114 B: WCT-120	
BMT-093	LA: WCT-137 LB: WCT-138 RA: WCT-136 RB: WCT-090			
BMT-093	LA: WCT-137 LB: WCT-138 RA: WCT-136 RB: WCT-090			
BMT-093	LA: WCT-046 LB: WCT-053 RA: WCT-057 RB: WCT-049			
BMT-093				
BMT-093	LA: WCT-046 LB: WCT-053 RA: WCT-057 RB: WCT-049			
	LA: WCT-096 RA: WCT-086			
	LA: WCT-055 LB: WCT-102 RA: WCT-041 RB: WCT-093	A: WCT-054 B: WCT-063	A: WCT-080 B: WCT-065	
BMT-093	LB: WCT-138 RB: WCT-090	A: WCT-127 B: WCT-131	A: WCT-114 B: WCT-120	
		A: WCT-151 B: WCT-152	A: WCT-150 B: WCT-119	
	LA: WCT-096 RA: WCT-086			

APPLICATION LIST



CCM

Body Type



Brake Code



Brake Pads Front



Brake Pads Rear

# TOYOTA

APPLICATION LIST

DYNA	1995.05	1999.08	15B	4104	BU102, 112, 132, 142, 212, 222	D			
	2001.10				WU410, 420	D			
	2001.10				XZU404, 41#,42#, 43#	D		A1N060	
DYNA 100	2001.08	2006.02	2KD-FTV	2494	KDY220, 230	D			
DYNA 200	1989.10	1995.05	14B	3700	BU88, BU9#	D			
	1996.11		15B	4104	BU100, BU140	D			
DYNA 250			5L	2986	LN140	D			
HI-ACE	1975.11	1980.06	12R	1587	RH13/16/24/30/34/40	G			
	1980.06	1985.07	12R	1587	RH24/34	G			
	1987.08	1988.03	#Y	1812	YH56/66	G	AKE	A1N036	
	1988.03	1989.08	#Y	1812	YH56/66	G	AKE	A1N036	
	1982.12	1988.08	2Y	1812	YH50 P-U	G			
	1988.08	1989.08	2Y	1812	YH50 P-U	G			
	1982.12	1984.06	2Y-J	1812	YH50/60	G	AKE	A1N036	
	1984.06	1987.08	2Y-J	1812	YH50/60	G	AKE	A1N036	
	1977.02	1982	18R	1968	RH22/25/32/42	G	AKE		
	1980.06	1982.11	18R	1968	RH35/45	G			
	1989.08	1993.08	1RZ	1998	RZH102	G	AKE	A1N049	
	1989.08	1995.08	1RZ	1998	RZH109/119	G	AKE		
	2003.08		1RZ	1998	RZH10#,11#	G			
	1989.08	1993.08	1RZ/2RZ	1998	RZH113	G	AKE	A1N049	
	1993.08	1995.08	1RZ/2RZ	1998	RZH102/103/112/115	G			
	1987.08	1988.07	3Y	1998	YH51/61	G	AKE		
	1987.08	1988.08	3Y	1998	YH57G	G			
	1987.08	1989	3Y	1998	YH61	G			
	1988.07	1989.08	3Y	1998	YH51/61	G	AKE		
	1982.12	1987.08	3Y-J	1998	YH51/52/61/62/71	G	AKE		
	1982.12	1987.08	3Y-U	1998	YH51/61/71	G	AKE		
	2003.07		1TR	2000	TRH102, 112, 122, 124	G		A1N050	
	1982.12	1984.01	L	2188	LH50/60/70	D			
	1995.08	1998.04	#R	2438	RCH12	G			
	1997.03		#R	2438	RCH22	G			
	1997.03		#R	2438	RCH28	G			
1989.08	1995.08	2RZ	2438	RZH103	G	AKE			
2006.08		2RZ	2438	RZH125, 135, 153, 155	G				



Brake Master Cylinder

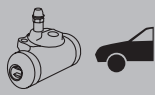

Brake Wheel Cylinder Front

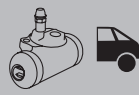

Brake Wheel Cylinder Rear Left

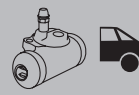

Brake Wheel Cylinder Rear Right

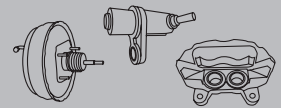

Other Parts

	LA: WCT-055 LB: WCT-102 RA: WCT-041 RB: WCT-093	A: WCT-054 B: WCT-063	A: WCT-080 B: WCT-062	
				ABS RRL: AST-015 ABS RRR: AST-006
				ABS RRL: AST-015 ABS RRR: AST-006 ABS Skid: AST-002
				ABS RRL: AST-013 ABS RRR: AST-005
	LA: WCT-046 LB: WCT-053 RA: WCT-057 RB: WCT-049	A: WCT-023 B: WCT-025	A: WCT-020 B: WCT-016	
	LA: WCT-096 RA: WCT-086			
		A: WCT-027	A: WCT-027	
		A: WCT-033	A: WCT-033	
		A: WCT-033	A: WCT-033	
		A: WCT-019	A: WCT-019	
	LA: WCT-055 RB: WCT-093	A: WCT-019	A: WCT-019	
		A: WCT-019	A: WCT-019	
		A: WCT-019	A: WCT-019	
		A: WCT-019	A: WCT-019	
BMT-016		A: WCT-004	A: WCT-004	BB: BBT-055
BMT-007		A: WCT-004	A: WCT-004	
BMT-016				
BMT-198		A: WCT-004	A: WCT-004	BB: BBT-055
		A: WCT-019	A: WCT-019	
		A: WCT-019	A: WCT-027	
		A: WCT-019	A: WCT-019	
		A: WCT-019	A: WCT-019	
	RB: WCT-032	A: WCT-019	A: WCT-004	
	RB: WCT-032	A: WCT-019	A: WCT-005	
BMT-198				BB: BBT-055
	RA: WCT-032	A: WCT-005	A: WCT-005	
		A: AT-051	A: AT-051	BC FL: A5L023 BC FR: A5R023
		A: AT-051	A: AT-051	BC FL: ET-065L BC FR: ET-065L
				BC FL: A5L023 BC FR: A5R023
		A: WCT-004	A: WCT-004	BC FL: ET-065L BC FR: ET-065R
BMT-198				

APPLICATION LIST



CCM

Body Type



Brake Code



Brake Pads Front



Brake Pads Rear

# TOYOTA

APPLICATION LIST

Model	Start Year	End Year	CCM	Body Type	Brake Code	Brake Pads Front	Brake Pads Rear	
HI-ACE	1996.08	1998.04	RZ-E	2438	RCH18	G		
	1995.08	1996.12	#L	2446	LXH1# T	D		
	1996.12	1997.08	#L	2446	LXH1#/2# T	D		
	1984.01	1987.08	2L	2446	LH51/61/71	D	AKE	
	1986.08	1989.08	2L	2446	LH56/66 4WD	D	SUM	
	1987.08	1988.08	2L	2446	LH51/61	D	AKE	
	1988.08	1989.08	2L	2446	LH71/80/85	D	AKE	
	1989	1995.08	2L	2446	LH118/108 4WD	D		
	1989.08	1993.08	2L	2446	LH100/102/104/110/112/114	D	AKE-OPT	A1N049
	1993.08	1997.01	2L	2446	LH100/102/104/110/112/114	D	AKE	
	1995.08	1997.01	2L	2446	LXH12/22	D		A1N049
	1996.12	1997.08	2L-T	2446	LXH12/18/22/28 T 4WD	D	SUM	A1N050
	2001.08		2KD-FTV	2494	KLH12/22 D4D	D		
	2001.08		2KD-FTV	2494	KLH18/28 D4D	D		
	1989.08	1993.08	3L	2779	LH107 4WD	D		
	1989.08	1995.08	3L	2779	LH109/119/129 4WD	D	AKE	A1N049
	1989.08	1995.08	3L	2779	LH113/114/123	D		
	1989.08	1995.08	3L	2779	LH125	D		
	1995.08	1998.08	3L	2779	LH109/119/129 4WD	D		A1N049
	1995.08	1998.08	3L	2779	LH113/114/123	D		
	1995.08	1998.08	3L	2779	LH125	D		
	1993.08	1995.11	1KZ	2982	KZH100/106/110	D		
	1997.01		1KZ	2982	KZH100/106/110	D		
HI-LUX	1974.08	1980.09	12RJ	1587	RN20/25/30/33/34/40/43	G		
	1988.09	1994.07	2Y	1812	YN80/85	G	AKE	
	1983.11	1987.02	2Y-J	1812	YN51/56/61	G	AKE	
	1986.08	1989.03	3Y	1998	YN60/61/65 2&4 WD	G		
	1983.11	1986.08	3Y-J	1998	YN57/60/61 2&4 WD	G		
	1983.11	1986.08	3Y-J	1998	YN65 4WD	G	SUM	A1N017
	1992.08		L	2188	LN10# /110	D	AKE	A1N017
	1992.08	1993.08	L	2188	LN130	D	AKE	A1N017
	1997.08	2000.08	L	2188	LN190	D		
	2000.08	2001.08	L	2188	LN190	D		
	1986.08	1988.07	4Y	2237	YN58/62/67	G	SUM	A1N017
	1988.08	1994.07	4Y	2237	YN92/106/110	G	SUM	A1N021
	1988.08	1992.08	22R	2367	RN106/110 JPP	G		
	1992.08		22R	2367	RN106/110 JPP	G	AKE	
	1997.08	2001.08	RZ	2438	RZN168, 173	G		



Brake Master Cylinder



Brake Wheel Cylinder Front

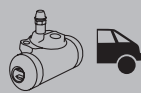

Brake Wheel Cylinder Rear Left

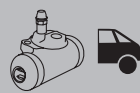

Brake Wheel Cylinder Rear Right

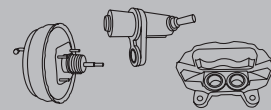

Other Parts

				BC FL: A5L023 BC FR: A5R023
		A: AT-051	A: AT-051	BC FL: ET-065L BC FR: ET-065R
		A: AT-051	A: AT-051	
	LA: WCT-052 LB: WCT-031 RA: WCT-032 RB: WCT-056	A: WCT-005	A: WCT-005	
		A: WCT-011	A: WCT-011	
		A: WCT-005	A: WCT-005	
		A: WCT-019	A: WCT-019	
BMT-007		A: WCT-027	A: WCT-027	BC FL: ET-065L BC FR: ET-065R
BMT-016		A: WCT-004	A: WCT-004	BC FL: ET-065L BC FR: ET-065R
BMT-007		A: WCT-004	A: WCT-004	BC FL: ET-065L BC FR: ET-065R
		A: AT-051	A: AT-051	BC FL: ET-065L BC FR: ET-065R
		A: AT-051	A: AT-051	BC FL: ET-065L BC FR: ET-065R
				BC FL: ET-065L BC FR: ET-065R
				BC FL: ET-065L BC FR: ET-065R
BMT-016			A: WCT-027	A: WCT-027
BMT-016			A: WCT-019	
BMT-016			A: WCT-003	
BMT-016				
BMT-198				
BMT-198				
BMT-198				
BMT-129				
BMT-129				
		A: WCT-019	A: WCT-019	
BMT-212		A: WCT-019	A: WCT-005	
BMT-069			A: WCT-005	
BMT-091		A: WCT-033	A: WCT-033	
BMT-069		A: WCT-019	A: WCT-033	
BMT-091		A: WCT-019	A: WCT-019	
		A: WCT-027	A: WCT-027	
BMT-258				
BMT-258				
		A: AT-050	A: AT-050	
BMT-048		A: WCT-007	A: WCT-007	
BMT-048		A: WCT-007	A: WCT-007	
BMT-258		A: WCT-007	A: WCT-007	

APPLICATION LIST



CCM

Body Type



Brake Code



Brake Pads Front



Brake Pads Rear

# TOYOTA

APPLICATION LIST

HI-LUX	2001.08	2005.08	2KD-FTV	2446	KDN165, 170	D		A1N029	
	2005.08		2KD-FTV	2446	KDN165, 170	D		A1N029	
	1983.11	1988.08	2L	2446	LN41 2&4 WD	D			
	1983.11	1988.08	2L	2446	LN56/60 2&4 WD	D			
	1983.11	1988.08	2L	2446	LN65 4WD	D	SUM	A1N017	
	1988.08	1992.10	2L	2446	LN130	D			
	1988.09	1992.08	2L	2446	LN10# /110	D	AKE		
	1988.09	1991.10	2L	2446	LN80	D	AKE		
	1988.09	1991.10	2L	2446	LN85/90	D	AKE		
	1991.10	1992.01	2L	2446	LN10# /110	D	AKE		
	1991.10	1997.08	2L	2446	LN85/90	D	AKE		
	1992.01		2L	2446	LN10# /110	D	AKE		
	1993.04	1995.11	2L	2446	LN130	D	AKE		
	1997.08	2000.12	2L	2446	LN165/170 T	D	SUM	A1N021	
	2000.12		2L-T	2446	LN165/170 T	D	SUM	A1N021	
	1988.08	1991.08	3L	2779	LN100/106/131	D			
	1991.08		3L	2779	LN100/106/107/131	D			
	1998.08		5L	2986	LN147	D			
		3GR-FSE	2994	KDN165L	G				
LAND-CRUISER	1984.11	1988.01	22R	2367	RJ70	G	SUM	A1N017	
	1984.11	1985.10	2L	2446	LJ70	D	SUM	A1N017	
	1985.10	1988.03	2L-T	2446	LJ7# T	D	SUM	A1N017	
	1988.03	1990.03	2L-T	2446	LJ7# T	D	SUM		
	1992.08	1993.05	2LT..	2446	LJ7# T	D	SUM	A1N021	A2N012
	1990.01	1992.08	2LTE	2446	LJ7# T	D	SUM	A1N021	A2N012
	1993.05	1996.03	1KZ-T	2982	KZJ7# T	D	SUM	A1N021	A2N012
	1985.10	1987.09	VM	3400	BJ73	D			
	1987.09	1994.02	VM	3400	BJ73	D	SUM	A1N017	
	1980.08	1984.10	3B	3431	BJ 42, 45, 46	D			
	1980.08	1984.10	3B	3431	BJ40, 43, 60, 61	D			
	1984.11	1988.08	3B	3431	BJ61, 70, 73, 75	D	SUM	A1N017	
	1985.10	1987.08	3B	3431	BJ71	D	SUM	A1N017	
	1987.08	1990.01	3B	3431	BJ71	D	SUM	A1N017	
	1990.01	1991.08	1PZ	3470	PZJ70/73/75/77	D		A1N021	
	1974.08	1979.02	F	3878	FJ40, 43, 45, 55	G			
	1981.05	1986.01	12H-T	3980	HJ60 T	D	SUM	A1N017	
	1985.10	1987.09	12H-T	3980	HJ61	D			
	1987.09	1990.01	12H-T	3980	HJ61	D			
	1981.03	1987.08	2H	3980	HJ40/43/45/47/60/75	D	SUM	A1N017	
	1990.01	1995.01	1HZ	4164	HZJ71 (with clutch booster)	D	+ABS	A1N021	
	1995.01	1999.08	1HZ	4164	HZJ71	D	+ABS	A1N144	
	1999.08	2001.08	1HZ	4164	HZJ7#	D		A1N144	
	1975.01	1976.04	2F	4230	FJ40, 43, 45, 55	D			
	1975.01	1980.08	2F	4230	FJ60	D			
	1975.01	1987.08	2F	4230	FJ61, 65	D			



Brake Master Cylinder

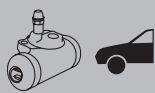

Brake Wheel Cylinder Front

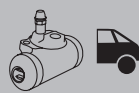

Brake Wheel Cylinder Rear Left

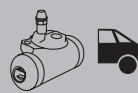

Brake Wheel Cylinder Rear Right

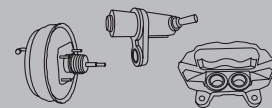

Other Parts

BMT-258		A: AT-051	A: AT-051	
BMT-258		A: AT-051	A: AT-051	
		A: WCT-033	A: WCT-033	
BMT-069		A: WCT-033	A: WCT-033	BB: BBT-051
BMT-091		A: WCT-033	A: WCT-033	BB: BBT-051
BMT-052		A: WCT-019	A: WCT-007	
BMT-052		A: WCT-019	A: WCT-007	
BMT-075		A: WCT-019	A: WCT-005	
BMT-075		A: WCT-019	A: WCT-019	
BMT-052		A: WCT-019	A: WCT-007	
MT-206		A: WCT-005	A: WCT-005	
BMT-052		A: WCT-019	A: WCT-019	
BMT-052		A: WCT-019	A: WCT-019	
BMT-221		A: WCT-019	A: WCT-019	
BMT-258		A: WCT-005	A: WCT-005	
		A: WCT-007	A: WCT-007	
BMT-145		A: WCT-007	A: WCT-007	BB: BBT-034
BMT-222	LA: AT-051			
BMT-222				
BMT-061		A: WCT-013	A: WCT-013	
BMT-022		A: WCT-013	A: WCT-013	
BMT-022		A: WCT-013	A: WCT-003	
BMT-022		A: WCT-013	A: WCT-003	
BMT-034		A: WCT-013	A: WCT-013	
BMT-234		A: WCT-003	A: WCT-003	
MT-156		A: AT-036	A: AT-036	
			A: WCT-011	
			A: WCT-011	
BMT-061		A: AT-036	A: AT-036	
BMT-061		A: AT-036	A: AT-036	
BMT-022		A: AT-036	A: WCT-011	
BMT-061		A: AT-036	A: AT-036	
BMT-022		A: AT-036	A: WCT-011	
BMT-034		A: AT-036	A: WCT-011	
				BB: BBT-054
BMT-022		A: AT-036	A: AT-036	
BMT-061		A: AT-036	A: AT-036	
BMT-061	RA: AT-024RFB	A: AT-036	A: AT-036	
BMT-102		A: AT-036	A: AT-036	
BMT-102		A: AT-036	A: AT-036	
BMT-239		A: AT-036	A: WCT-011	
BMT-061		A: AT-036	A: AT-036	BC FL: ET-039L BC FR: ET-039R BB: BBT-054
BMT-061		A: AT-036	A: AT-036	BC FL: ET-039L BC FR: ET-039R
		A: AT-036	A: AT-036	BC FL: ET-039L BC FR: ET-039R

APPLICATION LIST



CCM

Body Type



Brake Code

Brake Pads  
FrontBrake Pads  
Rear

# TOYOTA

APPLICATION LIST

LAND-CRUISER	1976.04	1986.04	2F	4230	FJ40, 43, 45	D			
	1976.04	1980.07	2F	4230	FJ55	D			
	1980.07	1987.08	2F	4230	FJ55	D			
	1980.08	1984.11	2F	4230	FJ60	D			
	1984.11	1987.08	2F	4230	FJ60	D			
	1986.04	1987.08	2F	4230	FJ40, 43, 45	D			
	1999.08	2004.04	1FZFE	4477	FZJ71, 74, 78, 79	G			
LAND-CRUISER 100	1998.01	2000.08	1HDFTE	4164	HDJ100 T	D		A1N144	A2N004
	2000.08	2002.08	1HDFTE	4164	HDJ100 T	D		A1N144	A2N004
	2002.08		1HDFTE	4164	HDJ100 T	D		A1N144	A2N004
	1998.01	2001	2UZFE	4664	UZJ100	G		A1N144	A2N004
LAND-CRUISER 120	2002.09	2004.08	1KD	2982	KDJ12# 5 Speed	D		A1N011	A2N012
	2004.08		1KD	2982	KDJ12# 6 Speed	D		A1N011	A2N012
LAND-CRUISER 80	1995.01	1998.01	1HDFT	4164		D	SUM	A1N023	
	1990.01	1995.01	1HD-T	4164	HDJ80 T	D	SUM	A1N023	
	1990.01	1998.01	1HD-T	4164	HDJ81 T	D		A1N023	
	1990.01	1998.01	HZ	4200	HZJ80	D			
	1995.01	1996.08	1FZ	4476	FZJ80	G	SUM	A1N023	A2N004
	1996.08	1998.01	1FZ	4476	FZJ80	G	SUM	A1N023	A2N004
LAND-CRUISER 90	2000.10	2002	1KD	2982	KDJ90/95 D4D DI	D		A1N005	A2N004
	1996.04	1998.05	1KZ-TE	2982	KZJ9# T	D	SUM+ABS	A1N029	A2N012
	1998.05	2000.08	1KZ-TE	2982	KZJ9# T	D	SUM-ABS	A1N029	A2N012
	2000.08		1KZ-TE	2982	KZJ9# T	D	SUM	A1N029	A2N012
	1995		5VZ-FE	3378	VZJ9# V6	G		A1N029	A2N012
LITE-ACE	1979.08	1982.10	4K	1290	KM11, KM20	G			
	1985.09	1988.08	5K	1486	KM30, KM36	G	AKE		
	1988.08	1992.01	5K	1486	KM30, KM36	G	AKE	A1N078	
	1992.01	1995.01	5K	1486	KR21	G	AKE	A1N028	
	1992.01	1995.01	5K	1486	KR27	G	AKE		
	1982.10	1988	1C	1839	CM20, 25, 26, 35, 50, CR26	D	AKE		
	1985.09	1990.05	2C	1974	CM30G, 31V, 36V, 41V	D			
	1985.10	1990.05	2C	1974	CM41V	D			
	1988.08	1992.05	2C	1974	CM51, 52, 55	D		A1N078	
	1990.05	1992.01	2C	1974	CM30G, 31V, 36V, 41V	D			
	1992.01	1995.01	2C	1974	CR21	D	AKE	A1N028	
	1992.01	1995.01	2C	1974	CR27	D	AKE		
	1992.01	1995.01	4Y-EC	2237	YR29LV	G	AKE		
1992.01	1995.01	Y	2237	YR22	G	AKE	A1N028		
MODEL-F	1982.11	1986.07	2Y-U	1812	YR20	G			
	1984.08	1987.08	2C	1974	CR21, 28	D			
	1987.05	1988.08	3Y-E	1998	YR21	G			





Brake Master Cylinder



Brake Wheel Cylinder Front

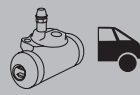

Brake Wheel Cylinder Rear Left

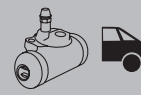

Brake Wheel Cylinder Rear Right

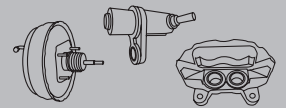

Other Parts

		A: AT-036	A: AT-036	BC FL: ET-039L BC FR: ET-039R
BMT-061		A: AT-036	A: AT-036	BC FL: ET-039L BC FR: ET-039R
		A: AT-036	A: AT-036	BC FL: ET-039L BC FR: ET-039R
BMT-061		A: AT-036	A: AT-036	BC FL: ET-039L BC FR: ET-039R
BMT-061		A: AT-036	A: AT-036	BC FL: ET-039L BC FR: ET-039R
BMT-061		A: AT-036	A: AT-036	BC FL: ET-039L BC FR: ET-039R
BMT-061		A: AT-036	A: AT-036	BC FL: ET-039L BC FR: ET-039R
BMT-303		A: AT-036	A: AT-036	
		A: AT-036	A: AT-036	
		A: AT-036	A: AT-036	
BMT-303		A: AT-036	A: AT-036	BC FL: ET-085L BC FR: ET-085R
BMT-303		A: AT-036	A: AT-036	
BMT-303		A: AT-036	A: AT-036	
BMT-303		A: AT-036	A: WCT-011	
BMT-303		A: AT-036	A: WCT-011	
BMT-170				
BMT-170				
		A: AT-036	A: AT-036	
BMT-170				
		A: WCT-010	A: WCT-010	
RHD: BMT-073		A: WCT-006	A: WCT-006	
RHD: BMT-087		A: WCT-006	A: WCT-006	
BMT-063		A: WCT-013	A: WCT-013	
BMT-089		A: WCT-013	A: WCT-006	
BMT-073				
BMT-073		A: WCT-006	A: WCT-006	
BMT-073		A: WCT-013	A: WCT-013	
		A: WCT-050	A: WCT-050	
BMT-087		A: WCT-006	A: WCT-006	
BMT-089		A: WCT-013	A: WCT-013	
BMT-089		A: WCT-013	A: WCT-006	
BMT-063		A: WCT-013	A: WCT-013	
BMT-063		A: WCT-013	A: WCT-013	
BMT-053 RHD: BMT-118		A: WCT-006	A: WCT-006	
BMT-025				
BMT-025		A: WCT-006	A: WCT-006	

APPLICATION LIST



CCM

Body Type



Brake Code



Brake Pads Front



Brake Pads Rear

# TOYOTA

APPLICATION LIST

MODEL-F	1987.05		3Y-E	1998	YR30/36 2&4WD	G			
	1988.08	1990.01	3Y-E	1998	YR21	G	AKE		
MR	1984.06	1989.12	4A	1587	AW11	G	AKE/AKE		
	1993.11	1999.08	3S	1998	SW20	G	AKE/AKE	A1N053	A2N044
	1989.12	1993.11	3S-G	1998	SW20G	G	AKE/AKE		A2N044
	1989.12	1991.12	3SGTE	1998	SW20GT T	G	AKE/AKE		A2N044
	1991.12	1995.06	3SGTE	1998	SW20GT T	G	AKE/AKE	A1N053	A2N044
MR-S	1999.12	2000.04	1ZZ	1794	ZZW30, 5F	G		A1N068	A2N044
	2000.04	2007	1ZZ	1794	ZZW30, 5F	G		A1N068	A2N044
	2000.08	2007	1ZZ	1794	ZZW30, 5FS SQ	G		A1N068	A2N044
PASEO	1995.08	1996.11	5E	1498	EL54	G	AKE	A1N034	
PICNIC	1996.09	2000	3S	1998	SXM10	G	SUM	A1N048	
	1997.09	1998.11	3C-T	2184	CXM10	D	SUM	A1N048	
	1998.11	2001.12	3C-T	2184	CXM10	D	SUM	A1N048	
PREVIA	2001.02		1CD-FTV	1995	CLR30 D4D	D		A1N101	A2N069
	2000.02		2AZFE	2438	ACR30	G		A1N115	A2N069
	1989.07	1996.07	2TZ	2438	TCR1#, TCR2#	G	AKE+ABS	A1N085	A2N047
	1996.08	2000.08	2TZ	2438	TCR1#, TCR2#	G		A1N096	A2N047
	1993.02	1998.01	2TZFE	2438	TCR1#, TCR2# w/ ABS	G		A1N085	A2N047
PRIUS	1997.12	2000.05	1NZ	1496	NHW10	H		A1N048	
	2000.05	2004.01	1NZ	1496	NHW11	H		A1N068	
PRIUS II	2003.09		1NZ	1496	NHW20	H		A1N068	
RAV-4	1994.04	1996.08	3S	1998	SXA10	G	SUM	A1N048	
	1996.08	1998.06	3S	1998	SXA10	G	SUM	A1N048	
	1998.06	2000	3S	1998	SXA10	G	SUM	A1N048	A2N031
RAV-4 II	2000.05		1ZZ-FE	1794	ZCA2# 2WD	G	SUM/ AKE+ABS	A1N008	A2N031
	2001.05	2005.04	1CD-FTV	1995	CLA2# 4WD D4D DI	D	SUM/ AKE+ABS		
	2000.08		1AZ-FE	1998	ACA2#	G	SUM/ AKE+ABS	A1N008	A2N031
	2000.08		1AZ-FE	1998	ACA2# 4WD	G	SUM/ AKE+ABS	A1N008	A2N031
RAV-4 III	2006.03		1AZ-FE	1998	ACA2#	G			
STARLET	1978.02	1984.10	2K	993	KP60	G			
	1989.06	1996	1E	999	EP80	G	AKE		
	1984.10	1989.05	1EL	999	EP70	G			
	1978.10	1982.10	3K	1166	KP62	G			
	1978.10	1983.07	4K	1290	KP61 CTT	G			



Brake Master Cylinder

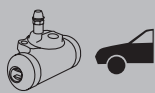

Brake Wheel Cylinder Front

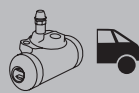

Brake Wheel Cylinder Rear Left



Brake Wheel Cylinder Rear Right

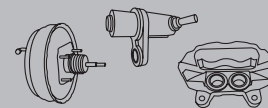

Other Parts

BMT-025		A: WCT-006	A: WCT-006	
		A: WCT-006	A: WCT-006	
BMT-115				
		A: WCT-015	A: WCT-014	BC FL: ET-073L BC FR: ET-073R ABS RRL: AST-013 ABS RRR: AST-011
		A: WCT-015	A: WCT-014	BC FL: A5L017 BC FR: A5R017 ABS RRL: AST-013 ABS RRR: AST-011
		A: WCT-015	A: WCT-014	BC FL: ET-073L BC FR: ET-073R ABS RRL: AST-013 ABS RRR: AST-011
BMT-122		A: WCT-026	A: WCT-022	
		A: WCT-184	A: WCT-184	
		A: WCT-184	A: WCT-184	
		A: WCT-184	A: WCT-184	
BMT-277				BC LR: A5L011 BC RR: A5R011
BMT-110				BB: BBT-049
BMT-110			A: WCT-030	BB: BBT-049
BMT-110				BB: BBT-049
		A: WCT-015	A: WCT-014	
		A: WCT-075	A: WCT-070	BC FL: A5L031 BC FR: A5R031 BC LR: A5L019 BC RR: A5R019
BMT-149		A: WCT-039	A: WCT-039	
BMT-148		A: WCT-039	A: WCT-039	
BMT-152		A: WCT-039	A: WCT-039	
BMT-297		A: WCT-081	A: WCT-081	
BMT-297				ABS RRL: AST-016 ABS RRR: AST-007
BMT-297		A: WCT-081	A: WCT-081	ABS RRL: AST-016 ABS RRR: AST-007
BMT-297		A: WCT-081	A: WCT-081	ABS RRL: AST-016 ABS RRR: AST-007
				ABS RRL: AST-016 ABS RRR: AST-007
		A: WCT-017	A: WCT-017	
BMT-062		A: AT-048L	A: AT-048R	
BMT-119		A: WCT-002	A: WCT-001	
		A: WCT-017	A: WCT-017	
		A: WCT-017	A: WCT-017	

APPLICATION LIST



CCM

Body Type



Brake Code



Brake Pads Front



Brake Pads Rear

# TOYOTA

APPLICATION LIST

STARLET	1983.07	1984.09	4K	1290	KP61	G			
	1989.06	1996	2E	1295	EP81	G		A1N043	
	1984.10	1989.05	2E-LU	1295	EP71, EP76	G			
	1996.01	1997.12	4E	1295	EP91	G	AKE	A1N034	
	1996.01	1996.11	4E-FE	1295	EP91 (W/ ABS)	G		A1N034	
	1996.01	1996.11	4E-FE	1295	EP91 (w/o ABS)	G	AKE Opt	A1N043	
	1996.11	1997.12	4E-FE	1295	EP91	G	AKE Opt	A1N034	
	1997.12	1999.07	4E-FE	1295	EP91	G		A1N034	
	1986.12	1987.08	1N	1453	NP70, NP76	D			
	1987.08	1989.05	1N	1453	NP70, NP76	D			
	1989.06	1995.12	1N	1453	NP80 (w/ ABS)	D		A1N034	
	1989.06	1995.12	1N	1453	NP80 (w/o ABS)	D	AKE	A1N043	
SUPRA	1988.08	1992	7MGE	2954	MA70	G			A2N080
	1987.01	1992	7MGTE	2954	MA70 TT	G			A2N080
	1993.05	1995.04	2JZGE	2997	JZA80	G		A1N056	A2N059
	1993.05	1995.04	2JZGE	2997	JZA80 TT (17 inch wheels)	G		A1N028	A2N027
	1995.04	2002.08	2JZGTE	2997	JZA80	G		A1N056	A2N059
	1995.04	2002.08	2JZGTE	2997	JZA80 TT (17 inch wheels)	G		A1N028	A2N027
TERCEL	1982.05	1986.05	2A	1295	AL20	G		A1N034	
TERCEL 4WD	1982.08	1986.05	3A	1452	AL25G 4WD	G		A1N034	
	1986.05		3A	1452	AL25G 4WD	G			
TRUCK	1975.01	1980.02	2F	4230	FA100, 110, 115	D			
	1969.03	1977.04	2D	6494	DA110, 115, 116, 118	D			
YARIS	1999.01	2005.08	1SZ-FE	998	SCP10 made in Japan	G	AKE	A1N067	A2N007
	2001.01	2005.11	1SZ-FE	998	SCP10 made in France	G	AKE	A1N068	A2N007
	1999.08	2001.09	2NZ-FE	1299	NCP10 made in Japan	G	AKE	A1N067	A2N007
	2001.09	2005.08	2NZ-FE	1299	NCP10 made in Japan	G	AKE	A1N068	A2N007
	2001.01	2005.11	2SZ-FE	1299	SCP12 made in France	G	AKE	A1N068	A2N007
	2001.12	2003.01	1ND-TV	1364	NLP10 D4D	D	AKE	A1N068	A2N007
	2003.01	2005	1ND-TV	1364	NLP10 D4D	D	AKE	A1N068	A2N007
	2000.03	2005	1NZ-FE	1497	NCP12 Tsport	G	AKE	A1N068	A2N007
YARIS II	2005.08	2008.11	1KR-FE	998	KSP90 made in Japan	G		A1N155	
	2005.11	2008.11	1KR-FE	998	KSP90 made in France	G		A1N155	
	2008.11		1KR-FE	998	KSP90 made in France For E/G 0XXXXXX-9XXXXXX	G		A1N155	



Brake Master Cylinder

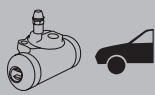

Brake Wheel Cylinder Front

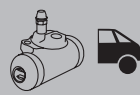

Brake Wheel Cylinder Rear Left

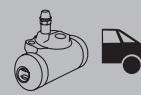

Brake Wheel Cylinder Rear Right

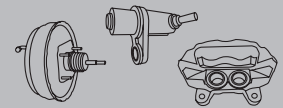

Other Parts

		A: WCT-017	A: WCT-017	
BMT-062		A: AT-048L	A: AT-048R	
BMT-119		A: WCT-002	A: WCT-001	
		A: WCT-026	A: WCT-022	
BMT-262		A: WCT-026	A: WCT-022	
BMT-262		A: WCT-026	A: WCT-022	
BMT-262		A: WCT-026	A: WCT-022	
		A: WCT-026	A: WCT-022	
BMT-119		A: WCT-002	A: WCT-001	
BMT-119		A: WCT-002	A: WCT-001	
BMT-062		A: WCT-002	A: WCT-001	
BMT-062		A: WCT-002	A: WCT-001	
		A: WCT-017	A: WCT-017	
		A: WCT-017	A: WCT-017	
BMT-260				
BMT-260				
MT-901		A: WCT-074	A: WCT-069	BC FL: A5L015 BC FR: A5R015
MT-901		A: WCT-074	A: WCT-069	BC FL: A5L015 BC FR: A5R015
MT-901		A: WCT-074	A: WCT-069	BC FL: A5L015 BC FR: A5R015
MT-901		A: WCT-074	A: WCT-069	BC FL: A5L015 BC FR: A5R015
MT-901		A: AT-049	A: AT-049	BC FL: A5L015 BC FR: A5R015
MT-901		A: WCT-074	A: WCT-069	BC FL: A5L015 BC FR: A5R015 BC LR: ET-086LR BC RR: ET-086RR
		A: WCT-074	A: WCT-069	BC FL: A5L015 BC FR: A5R015 BC LR: ET-086LR BC RR: ET-086RR
MT-901		A: WCT-075	A: WCT-070	BC FL: A5L015 BC FR: A5R015
				BC FL: A5L009 BC FR: A5R009
				BC FL: A5L009 BC FR: A5R009
				BC FL: A5L009 BC FR: A5R009

APPLICATION LIST



CCM

Body Type



Brake Code

Brake Pads  
FrontBrake Pads  
Rear

# TOYOTA

YARIS II	2008.11	2009.04	1KR-FE	998	KSP90 made in France For E/G A0XXXXX-A9XXXXX	G		A1N155	
	2008.11		1KR-FE	998	KSP90 made in Japan	G		A1N155	
	2008.11		1KR-FE	998	KSP90 ECO MODEL	G		A1N155	
	2009.04		1KR-FE	998	KSP90 made in France For E/G A0XXXXX-A9XXXXX	G		A1N155	
	2005.12	2008.11	2SZ-FE	1296	SCP90 made in France	G		A1N155	
	2005.11	2009.01	1ND-TV	1364	NLP90 D4D	D		A1N155	
	2006.07		2ZR-FE	1798	ZSP90 made in Japan	G		A1N155	
YARIS VERSO	1999.08	2001.09	2NZ	1299	NCP20	G	AKE	A1N068	A2N007
	2001.09		2NZ	1299	NCP20	G	AKE	A1N068	A2N007
	2001	2003.01	1ND-TV	1364	NLP20 D4D	D	AKE	A1N068	A2N007
	2003.01	2005	1ND-TV	1364	NLP20 D4D	D	AKE	A1N068	A2N007
	1999.09	2001.09	1NZ-FE	1497	NCP21	G	AKE	A1N068	A2N007
	2001.09		1NZ-FE	1497	NCP21	G	AKE	A1N068	A2N007

# VAUXHALL (+ see OPEL)

ASTRA Mk II	1984.09	1991.08	16V	1598	CC	G			
	1987.10	1993.02	C16NZ, C16LZ	1598	CC	G			
ASTRA Mk III	1996.01	2001.03	X14XE	1389	C	G			
	1996.02	1998.01	X14XE	1389	Estate	G			
	1996.09	1998.09	X14XE	1389		G			
	1991.09	1998.02	C16NZ, E16NZ	1598	CC	G			
	1991.09	1998.02	C16NZ, E16NZ	1598	Estate	G			
	1992.03	1998.09	C16NZ, X16SZR	1598		G			
	1991.03	1994.12	C16SE	1598	Estate	G			
	1992.05	1994.12	C16SE	1598		G			
	1991.12	1998.02	17D	1699	CC	G			
	1991.12	1998.02	17D	1699	Estate	G			
	1992.03	1992.09	17D	1699		G			
	1991.03	1994.12	17DR	1699	Estate	G			
	1992.07	1998.09	17DR	1699		G			
1994.11	1998.09	X17DTL	1699		G				
ASTRAVAN Mk III	1991.01	1994.08	17DR	1699		G			
CAVALIER Mk III	1988.09	1993.05	16SV	1598		G			
	1988.09	1995.11	E16NZ	1598		G			



Brake Master Cylinder

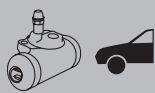

Brake Wheel Cylinder Front

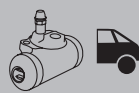

Brake Wheel Cylinder Rear Left

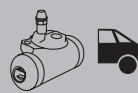

Brake Wheel Cylinder Rear Right

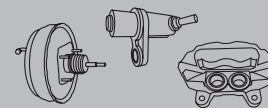

Other Parts

				BC FL: A5L009 BC FR: A5R009
				BC FL: A5L009 BC FR: A5R009
		A: WCT-074	A: WCT-074	
				BC FL: A5L009 BC FR: A5R009
		A: WCT-075	A: WCT-070	BC FL: A5L015 BC FR: A5R015
				BC FL: A5L015 BC FR: A5R015
MT-901		A: WCT-074	A: WCT-069	BC FL: A5L015 BC FR: A5R015
MT-901		A: WCT-074	A: WCT-069 B: WCT-074	BC FL: A5L015 BC FR: A5R015
MT-901		A: WCT-075	A: WCT-070	BC FL: A5L015 BC FR: A5R015
MT-901		A: WCT-075	A: WCT-070	BC FL: A5L015 BC FR: A5R015
MT-901		A: WCT-074	A: WCT-069	BC FL: A5L015 BC FR: A5R015
MT-901		A: WCT-075	A: WCT-069 B: WCT-074	BC FL: A5L015 BC FR: A5R015

		A: AE-OP01	A: AE-OP01	
		A: AE-OP01	A: AE-OP01	
		A: AE-OP02	A: AE-OP02	
		A: AE-OP02	A: AE-OP02	
		A: AE-OP02	A: AE-OP02	
		A: AE-OP02	A: AE-OP02	
		A: AE-OP02	A: AE-OP02	
		A: AE-OP02	A: AE-OP02	
		A: AE-OP01	A: AE-OP01	
		A: AE-OP01	A: AE-OP01	
		A: AE-OP01	A: AE-OP01	
		A: AE-OP01	A: AE-OP01	
		A: AE-OP01	A: AE-OP01	
		A: AE-OP01	A: AE-OP01	
		A: AE-OP01	A: AE-OP01	
		A: AE-OP01	A: AE-OP01	
		A: AE-OP02	A: AE-OP02	
		A: AE-OP01	A: AE-OP01	
		A: AE-OP02	A: AE-OP02	
		A: AE-OP02	A: AE-OP02	

APPLICATION LIST



CCM

Body Type



Brake Code



Brake Pads Front



Brake Pads Rear

## VAUXHALL (+ see OPEL)

CAVALIER Mk III	1993.09	1995.11	X16SZ	1598	CC	G			
	1988.09	1992.09	17D	1699	CC	G			
	1992.07	1995.11	17DR	1699	CC	G			
CORSA	1996.11	2000.09	X10XE	973		G			
	1994.09	2000.09	X14XE	1389		G			
	1993.03	2000.09	15D	1488		G			
	1993.03	1996.10	X15DT, 15DT	1488		G			
	1994.01	2000.09	X17D, 17D	1686		G			
CORSAVAN	1994.01	2000.09	C14NZ	1389		G			
MIDI	1988	1992	4ZC1	1994		G	SUM		
	1988	1994	4ZC1	1994	4WD	G	SUM		
	1988	1994	4FD1	2189		D	SUM		
	1988.06	1994	4FD1	2189	4WD	D	SUM		
NOVA	1992.02	1993.03	C16SE	1598	CC GSI KAT	G			
	1989.09	1993.03	C16SEI	1598	CC GSI	G			
	1988.05	1992.03	E16SE	1598	CC GSI	G			
TIGRA	1994.07		X14XE	1389		G			

## VOLKSWAGEN

TARO	1989.04	1994.09	2Y	1812	made in Germany	G			
	1989.04	1994.09	2Y	1812	made in Japan	G			
	1989.06	1994.07	4Y	2237	4WD	G			
	1989.06	1997.03	22R	2367	4WD	G			
	1989.06	1997.03	2L-T	2446	T	D			

## VOLVO

S40 / V40	1995.10	1998.01	B4164S	1587	VS	G	LUC		
	1998.01	1999.03	B4164S	1587	VS	G	LUC		
	1998.01	1999.08	B4184S	1731	VS	G	LUC		
	1995.10	1998.01	B4184S/ S3	1731	VS	G	LUC		
	1997.05	2000.07	B1494T/ T2	1855	VS T4 T	G			
	1996.07	1998.01	F8Q/ D4192T/2	1870	TII 90HP, 95HP	D	LUC		
	1998.01	2000.07	F8Q/ D4192T/2	1870	TII 90HP, 95HP	D	LUC		
	1997.10	2000.07	B4204 T	1948	VS	G			
	1995.10	1998.01	B4204S	1948		G	LUC		
	1998.01		B4204S	1948		G	LUC		





Brake Master Cylinder



Brake Wheel Cylinder Front

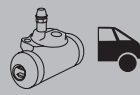

Brake Wheel Cylinder Rear Left

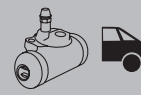

Brake Wheel Cylinder Rear Right

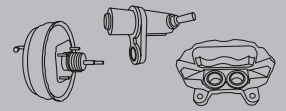

Other Parts

		A: AE-OP02	A: AE-OP02	
		A: AE-OP02	A: AE-OP02	
		A: AE-OP02	A: AE-OP02	
		A: AE-OP02	A: AE-OP02	
		A: AE-OP02	A: AE-OP02	
		A: AE-OP02	A: AE-OP02	
		A: AE-OP02	A: AE-OP02	
		A: AE-OP02	A: AE-OP02	
		A: AE-OP02	A: AE-OP02	
		A: AE-OP02	A: AE-OP02	
		A: AG-002LR	A: AG-002LR	
		A: AG-002LR	A: AG-002LR	
		A: AG-002LR	A: AG-002LR	
		A: AG-002LR	A: AG-002LR	
		A: AG-002LR	A: AG-002LR	
		A: AE-OP01	A: AE-OP01	
		A: AE-OP01	A: AE-OP01	
		A: AE-OP01	A: AE-OP01	
		A: AE-OP02	A: AE-OP02	

		A: WCT-005	A: WCT-005	
		A: WCT-005	A: WCT-005	
		A: AT-050	A: AT-050	
		A: WCT-007	A: WCT-007	
		A: WCT-005	A: WCT-005	

MM-069				
MM-069				
MM-069				
MM-069				
MM-069				
MM-069				
MM-069				
MM-069				
MM-069				
MM-069				
MM-069				

APPLICATION LIST



CCM

Body Type



Brake Code



Brake Pads Front



Brake Pads Rear

# XEDOS

6	1992.02		KF	1995	CAEPE V6	G	SUM/SUM	E1N026	E2N027
9	1993.07		KF	1995	TAFP V6	G	AKE	E1N038	
	1993.07		MILLER	2255	TA MILLER CYCLE	G	AKE/SUM	E1N038	
	1993.07		KL-ZE	2496	TA5P V6	G	AKE/SUM	E1N038	

APPLICATION LIST



**Brake Master  
Cylinder**

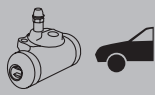

**Brake Wheel Cylinder  
Front**

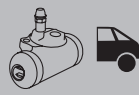

**Brake Wheel Cylinder  
Rear Left**

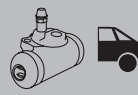

**Brake Wheel Cylinder  
Rear Right**

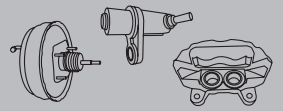

**Other Parts**



**APPLICATION LIST**



# BRAKE PADS DRAWINGS

# HOW TO MEASURE THE BRAKE PADS?

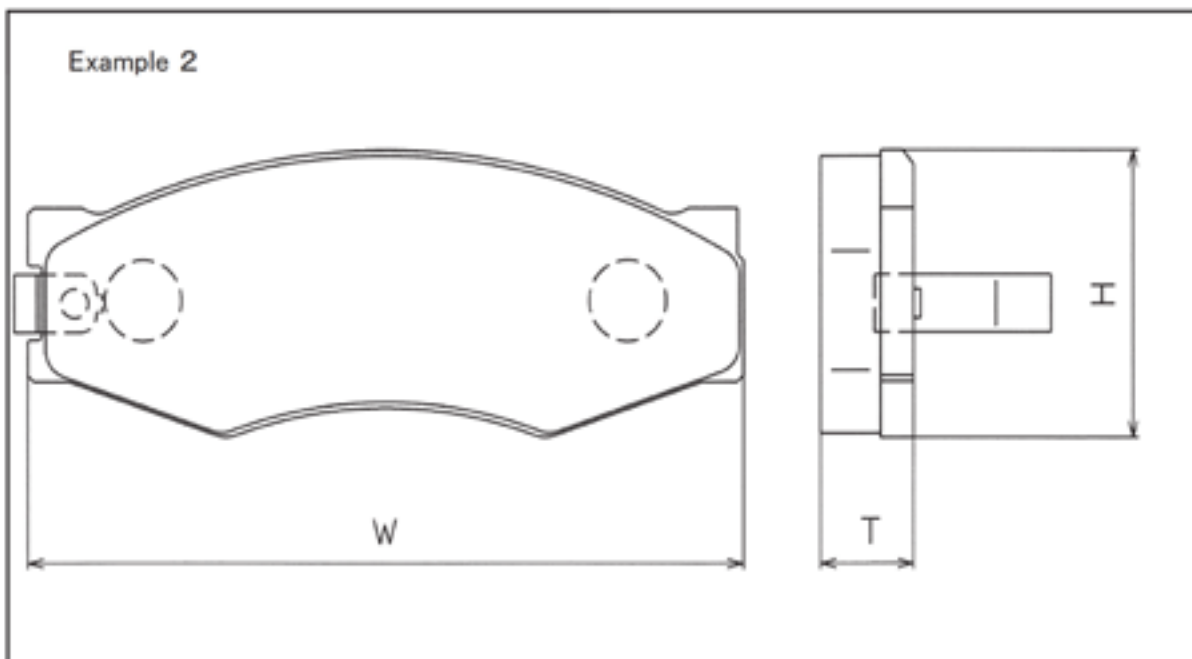
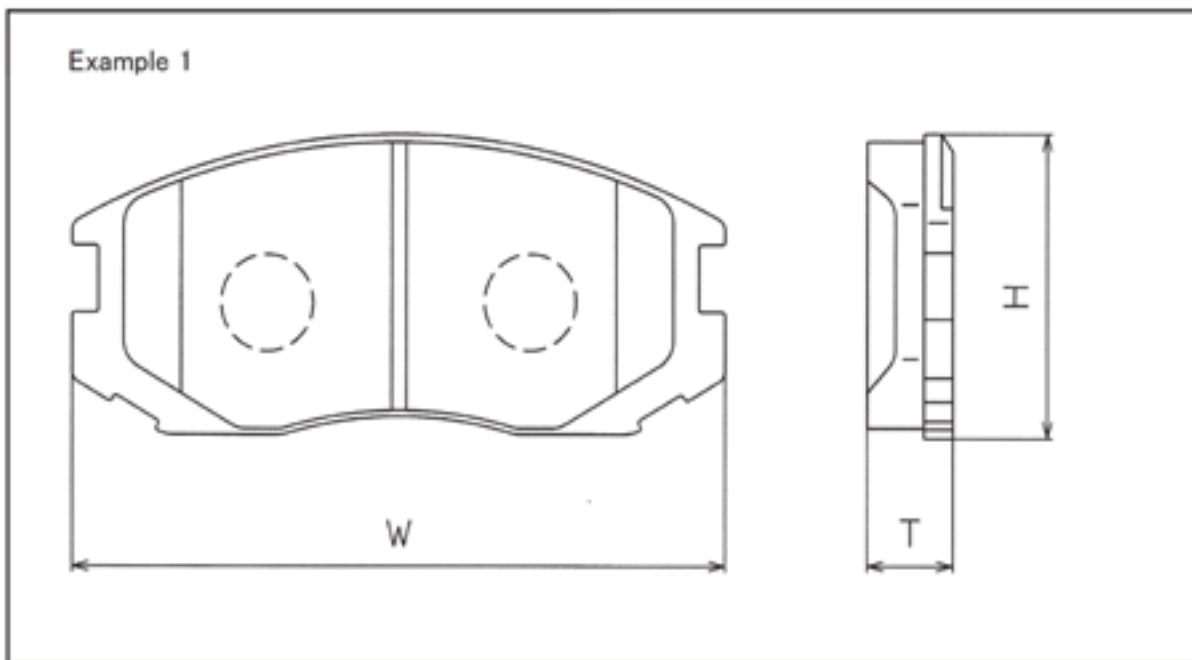

Rough size: there might be a slight difference in the dimensions.

**A1N005** ランドクルーザー  
LAND CRUISER HZJ71,74,76,79 99.08~  
front

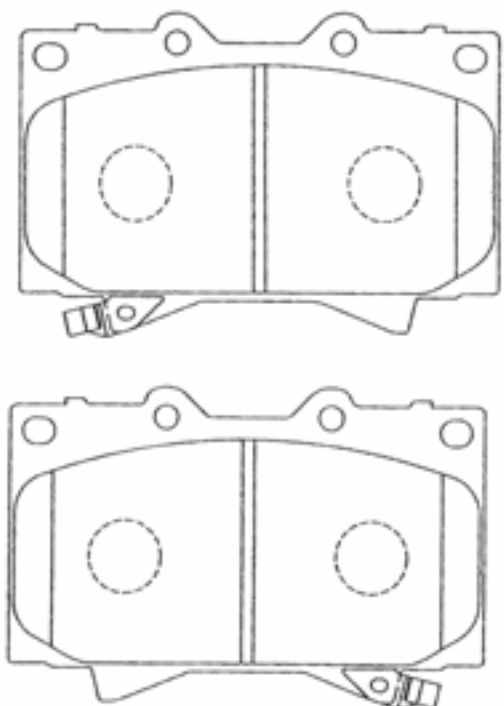

W : 119.5 H : 78.0 T : 17.5

**A1N008** RAV4 ACA20W,21W 00.05~  
front ZCA25W,26W 00.05~

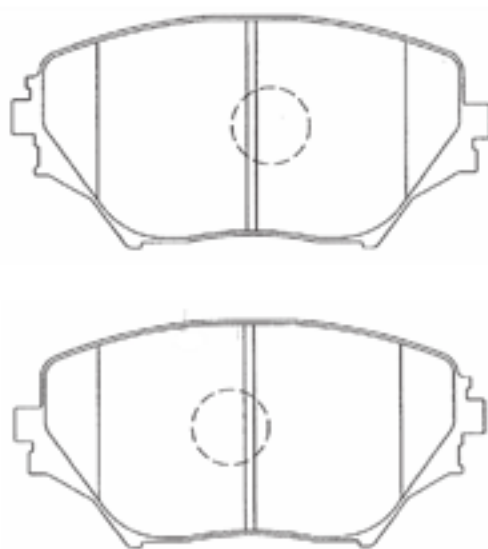

W : 123.0 H : 60.8 T : 17.5

**A1N006** マークII, クレスタ  
MARK II,CRESTA GX100,LX100 98.10~  
front クラウン GS151 98.10~  
CROWN

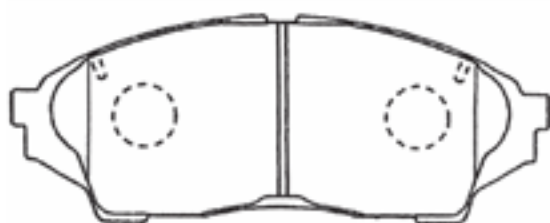

W : 137.0 H : 53.0 T : 17.5

**A1N009** セルシオ  
CELSIOR UCF30,31 00.08~  
front

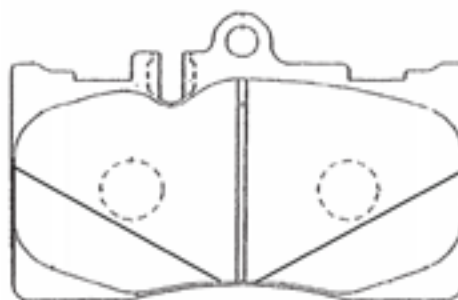

W : 118.6 H : 77.5 T : 16.0

**A1N011** ランドクルーザー  
LAND CRUISER  
front ハイラックスサーフ  
HILUX SURF  
RZJ120W,215W 02.09~  
RZN210W,215W 02.11~

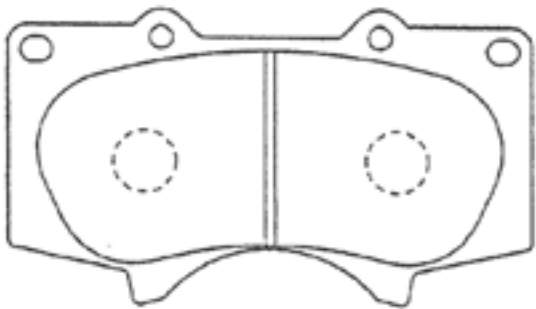
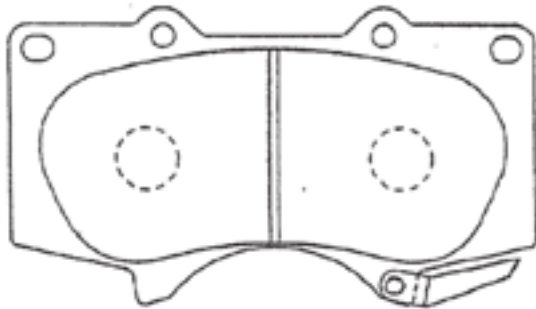
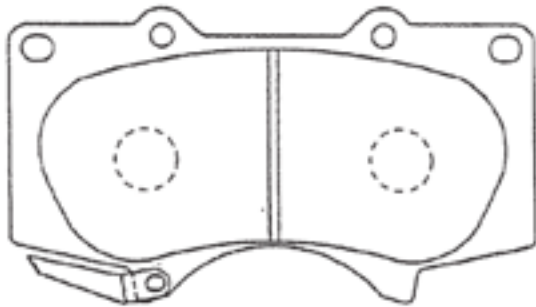

W : 134.6 H : 77.6 T : 17.0

**A1N013** タンドラ  
TUNDRA  
UCK30,40,VCK30,40 00.02~

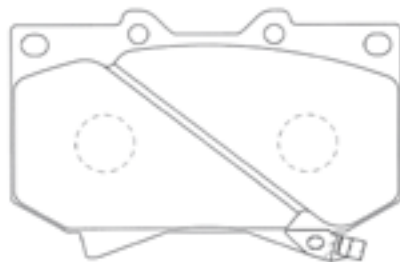
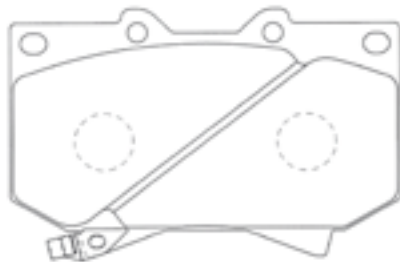

W : 119.5 H : 78.0 T : 17.0

**A1N016** マークIIバン  
MARK II van  
front マークIIワゴン  
MARK II WAGON  
YX76V,78V,LX76V 84.11~  
GX70G 88.10~

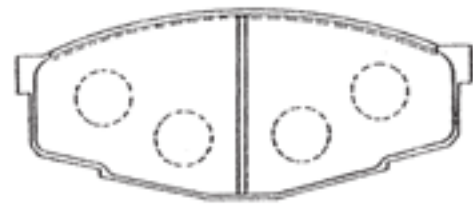

W : 116.0 H : 50.5 T : 15.5

**A1N017** ランドクルーザー  
LAND CRUISER  
front LJ71G,FJ62G 85.10~

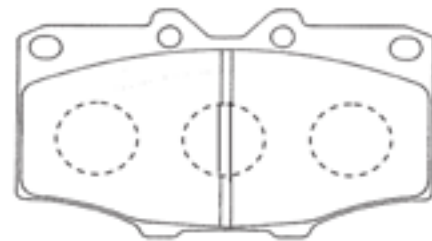

W : 107.3 H : 65.9 T : 15.0

**A1N019** クラウン  
CROWN  
front GS130,LS130 87.09~  
JZS130,131,141 90.08~

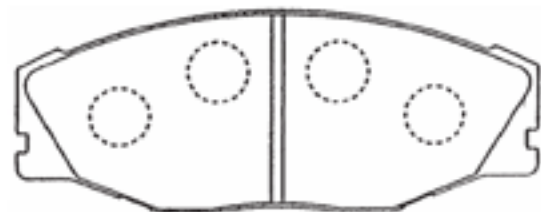

W : 133.3 H : 52.5 T : 15.0

**A1N020** マークII,クレスト  
MARK II,CRESTA  
front コンフォート  
COMFORT  
MX83,JZX81 89.08~  
GXS10,YXS10 95.12~

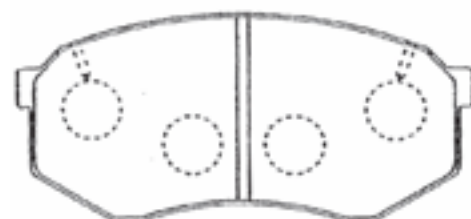

W : 116.0 H : 53.3 T : 15.5



**A1N021** ハイラックスサーフ  
HILUX SURF  
ランドクルーザー  
LAND CRUISER  
front

YN130G, LN130G 89.04~  
PZJ70, HZJ73HV 90.01~

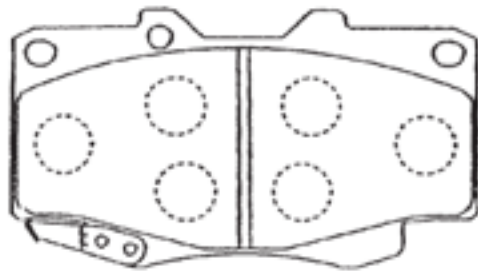
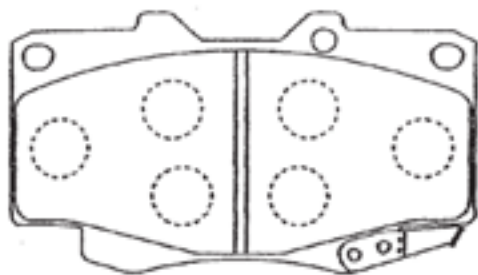
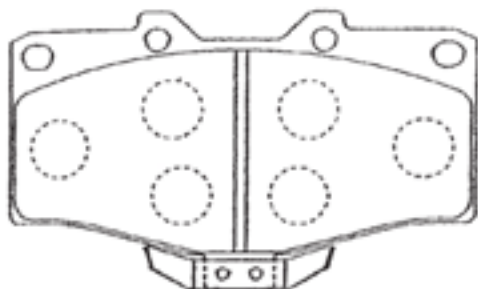

W : 119.3 H : 73.4 T : 15.0

**A1N023** ランドクルーザー  
LAND CRUISER  
front

FJ80G, FZJ80G 90.01~  
HDJ81V, HZJ81V 90.01~

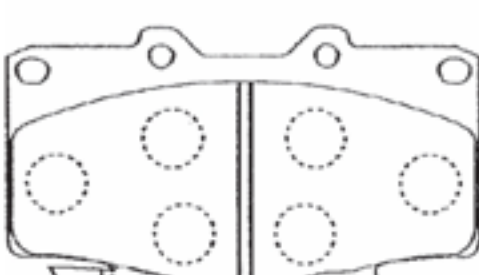
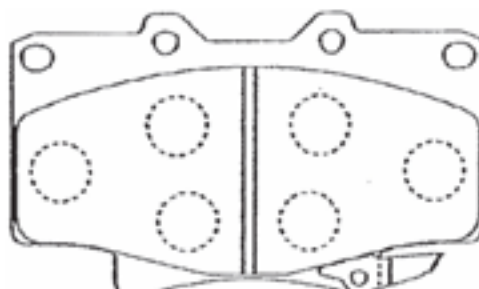

W : 119.3 H : 71.9 T : 15.0

**A1N025** セルシオ  
CELSIOR  
センチュリー  
CENTURY  
front

UCF20,21 94.10~  
GZG50 97.04~

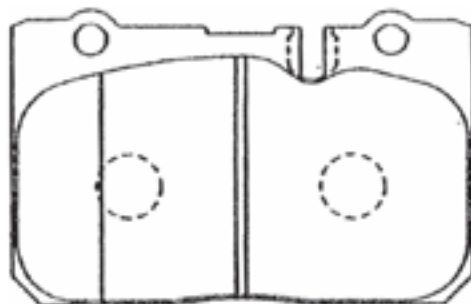

※センサー取付部 左右 各2枚

W : 115.6 H : 74.4 T : 17.0

**A1N026** ハイラックスサーフ  
HILUX SURF  
front  
LN130W,131V  
KZN130G,130W  
91.08~  
91.08~

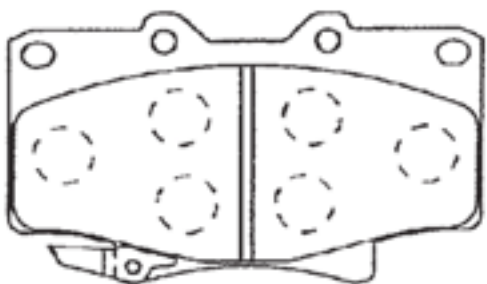
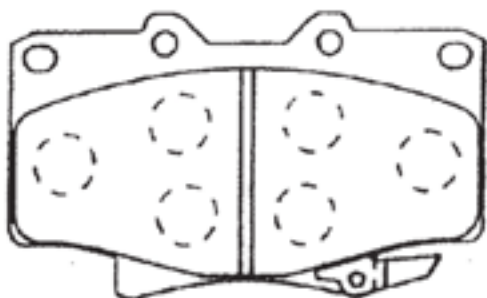
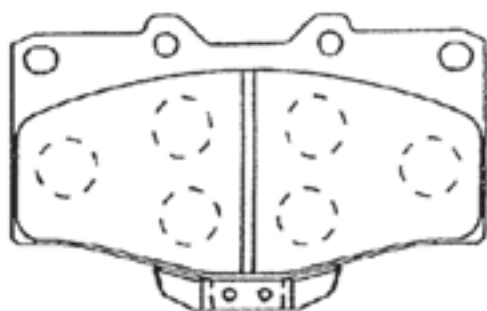

W : 119.3 H : 71.9 T : 15.0

**A1N028** セリカ  
CELICA  
スーフラ  
SUPRA  
front  
ST205  
JZA80(17"ホイール)  
94.02~  
94.08~

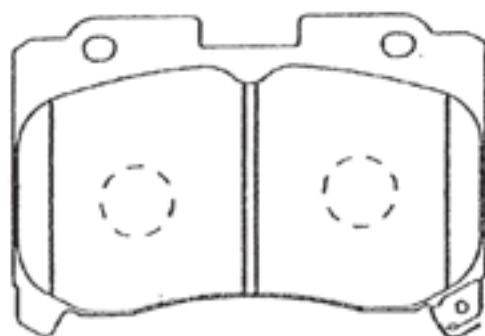
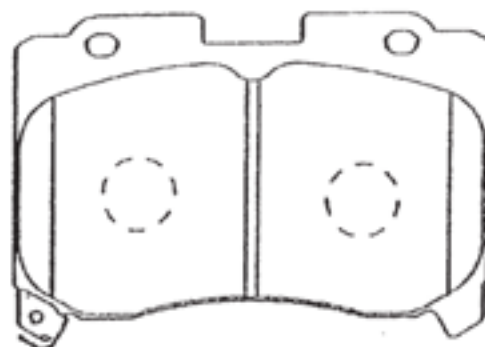

W : 119.3 H : 81.8 T : 17.0

**A1N029** ハイラックスサーフ  
HILUX SURF  
ランドクルーザー  
LAND CRUISER  
front

KZN185,RZN185 95.11~  
KZJ90W,95W 96.04~

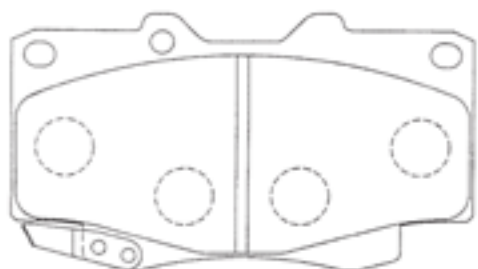
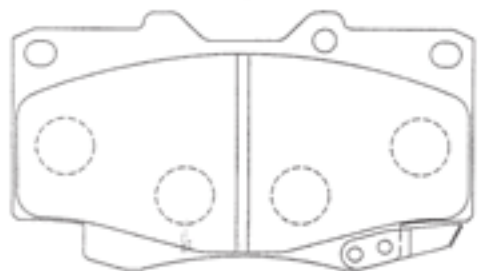
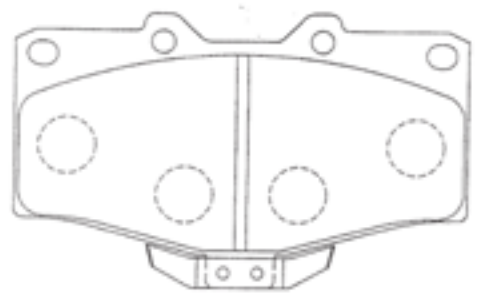

W : 119.6 H : 68.0 T : 17.0

**A1N034** ターセル,コルサ  
TERCEL,CORSA  
raum  
RAUM  
front

EL41,43,45,51 90.09~  
EXZ10,15 97.05~

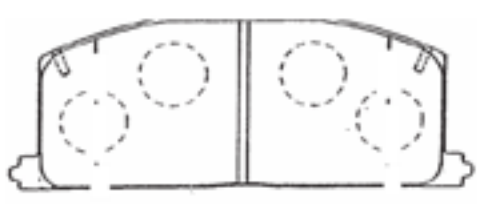

W : 119.7 H : 47.5 T : 15.0

**A1N036** センチュリー  
CENTURY  
ハイラックス  
HILUX  
front

VG40,45 87.09~  
YN80,85,LN80,85 88.09~

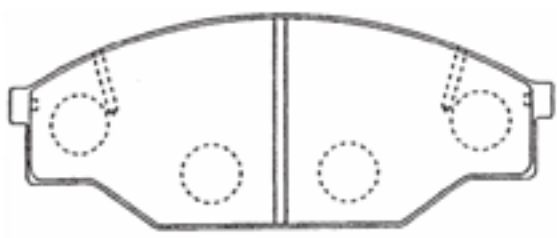

W : 140.1 H : 55.5 T : 15.0

**A1N038** セリカ  
CELICA  
カリーナED  
CARINA ED  
front

ST182,183,185 91.09~  
ST180,181,182 91.08~

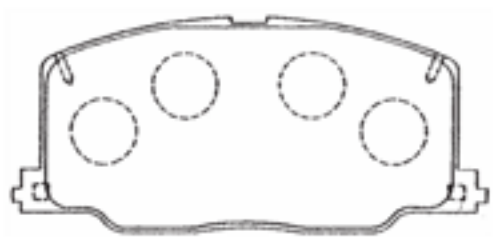

W : 119.7 H : 54.0 T : 15.0

**A1N041** ソアラ,アリスト  
SOARER, ARIST  
マークII,チェイサー  
MARK II, CHASER  
front

JZZ30,31,JZS147 91.05~  
GX105,115,JZX90 92.10~

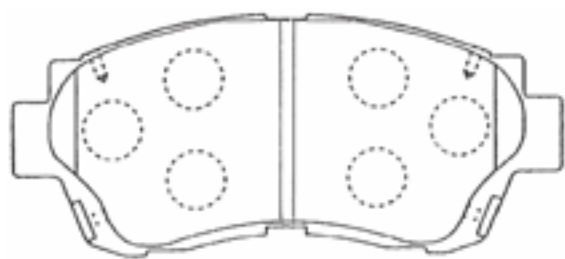

W : 141.0 H : 62.5 T : 17.0

**A1N043** スターレット  
STARLET  
front

EP82,91,NP80,90 89.12~



インナ W : 106.2 H : 46.0 T : 13.5  
アウト W : 132.0 H : 54.5 T : 13.5

DRAWINGS

**A1N046** ビスタ,カムリ SV32,VZV32,33 90.07~  
front



W : 144.4 H : 53.5 T : 15.5

**A1N050** グランビア GRANVIA ハイースバン HIACE VAN RCH11W,KCH10W 95.08~  
front RZH102V,112V 96.08~

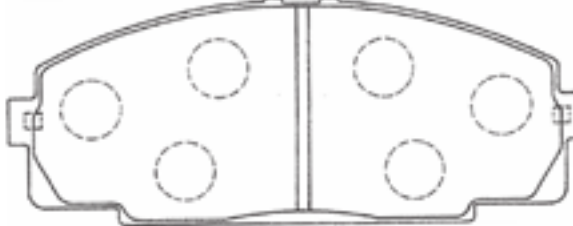

W : 145.5 H : 57.0 T : 15.5

**A1N048** カムリ,グランア CAMRY,GRACIA ビスタ,アルティオ VISTA,ARDEO SXV20,SXV20W 96.12~  
front ZZV50,ZZV50G 98.06~

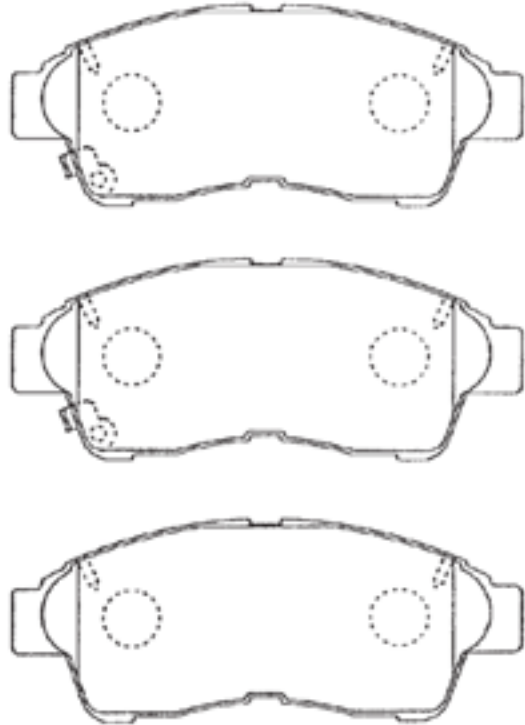

W : 133.1 H : 53.0 T : 17.5

**A1N053** カルディナ CALDINA セリカ CELICA ST215G,215W 97.08~  
front ST202,202C 97.12~

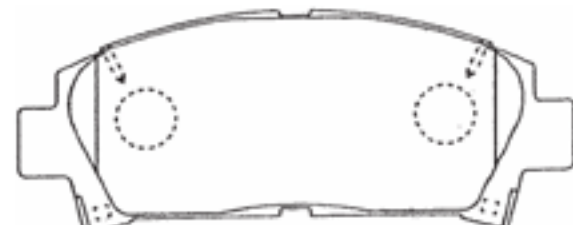

W : 141.1 H : 56.5 T : 15.5

**A1N049** ハイースワゴン HIACE WAGON ハイースバン HIACE VAN RZH100G,110G 89.08~  
front RZH102V,112V 89.08~

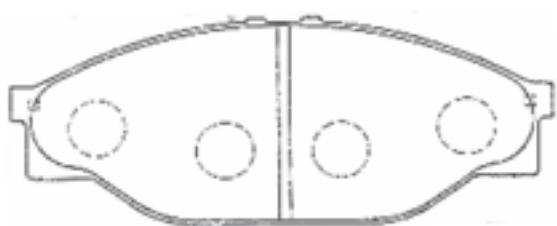

W : 140.1 H : 55.0 T : 15.5

**A1N054** ソアラ  
SOARER  
アリスト  
ARIST  
front

JZZ30,31,32  
JZS147  
91.05~  
91.10~

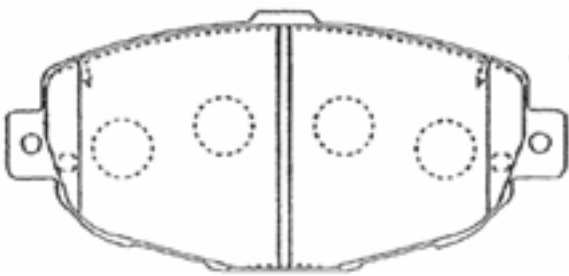
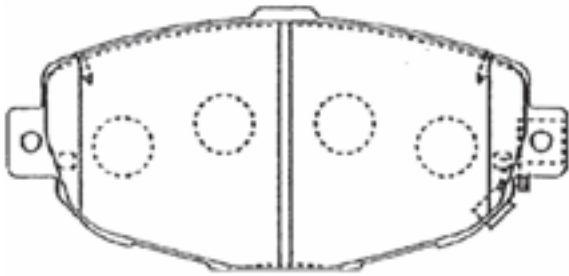
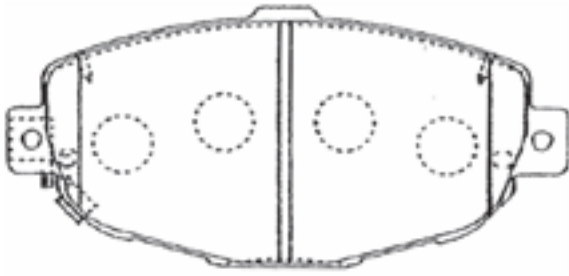

W : 144.1 H : 68.0 T : 17.1

**A1N055** セルシオ  
CELSIOR  
front

UCF10,11  
92.08~

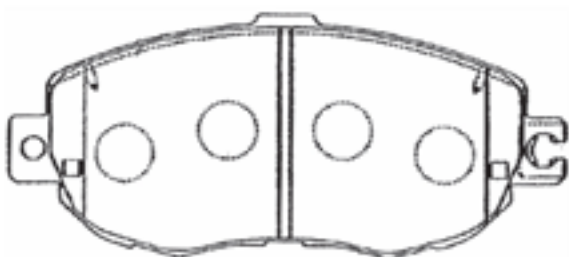
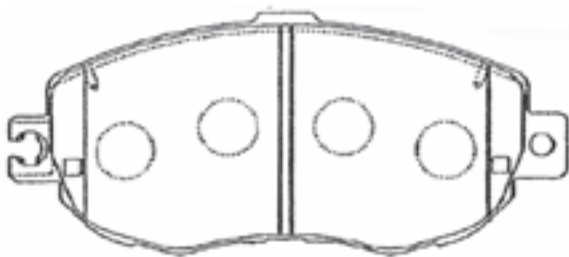

W : 144.0 H : 64.0 T : 17.0

**A1N056** セルシオ  
CELSIOR  
アルテッツァ  
ALTEZZA  
front

UCF10  
SXE10,GXE10  
92.08~  
98.10~

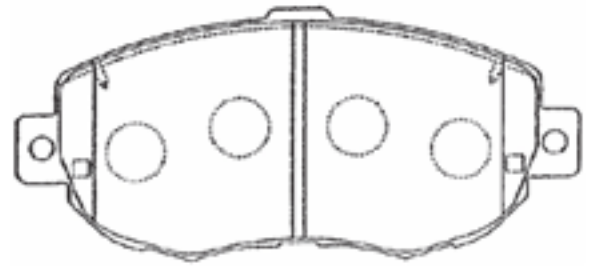
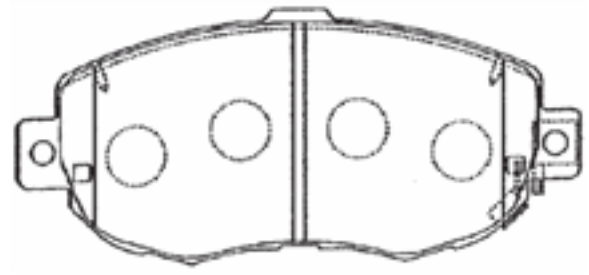
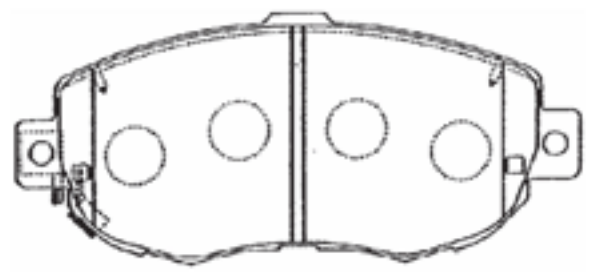

W : 144.0 H : 64.0 T : 17.0

**A1N060** ダイナトイース  
DYNA,TOYOACE  
レンジャー  
RANGER  
front

BU105,107,137  
BU107  
95.05~  
96.09~

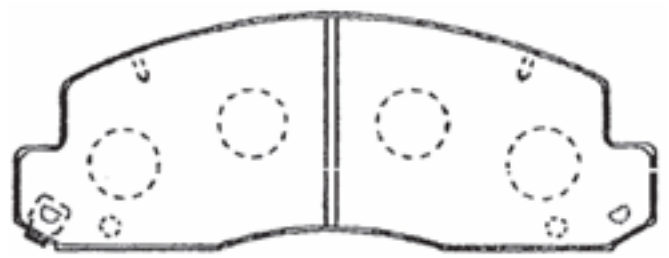

W : 166.3 H : 62.2 T : 20.0

DRAWINGS



**A1N061** コースター  
COASTER RB20,HZB30 84.08~  
front

W : 166.3 H : 62.2 T : 18.0

**A1N063** ハイース  
HIACE YH81,LH80,YY101 88.03~  
front タイトエース  
DYNA,TOYOACE LY101,111,YY101 96.01~

W : 140.1 H : 55.1 T : 15.5

**A1N065** ビスタアルティオ  
VISTA,ARDEO SV50,55,50G,55G 98.06~  
front アリオン,プレミオ  
ALLION,PREMIO AZT240,ZTT245 01.02~

W : 117.6 H : 58.5 T : 17.5

**A1N067** ヴォルフ  
VOLTZ SCP10,NCP10,15 01.03~  
front サクシード  
SUCCEED NCP50V,NLP51V 02.06~

W : 112.5 H : 46.7 T : 16.5

**A1N068** ファンカーゴ  
 FUN CARGO  
 ランクス,アレックス  
 RUNX,ALLEX  
 front

NCP20,21,25 01.04~  
 NZE121,124 01.04~

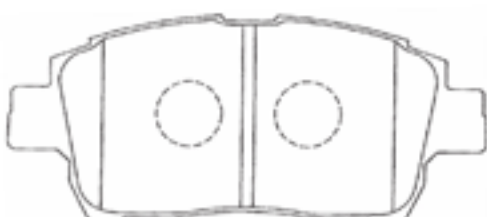
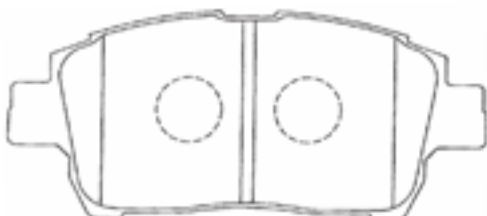
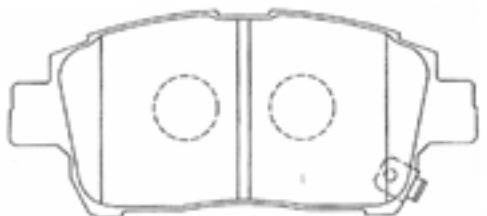
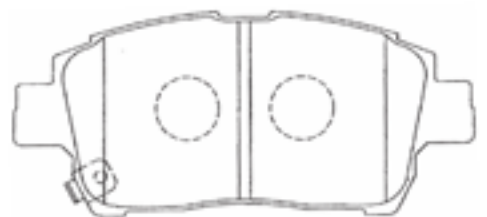

W : 116.5 H : 51.5 T : 16.5

**A1N078** タウンエースII  
 TOWN ACE NOAH  
 デリボーイ  
 DELIBOY  
 front

KM30G,YR20G 88.08~  
 KXC10V,CXC10 88.08~

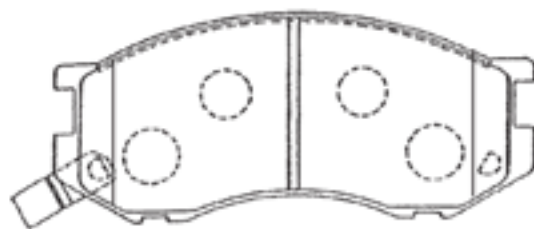
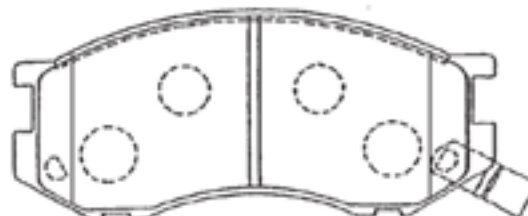
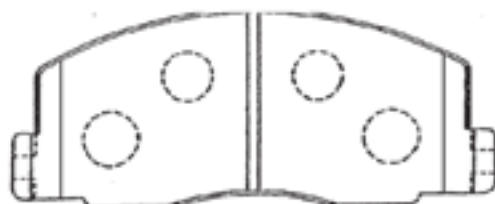

インチ W : 128.2 H : 52.0 T : 15.5  
 アウ W : 126.7 H : 55.0 T : 15.5

**A1N073** クイック  
 WISH  
 クラウン  
 CROWN  
 front

NZE10G,ANE10G 03.01~  
 GRS180,182 03.12~

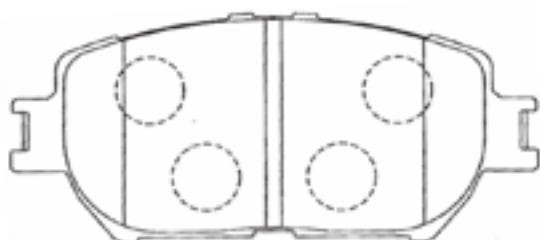

W : 131.5 H : 58.5 T : 17.5

**A1N083** タウンエース CR36V 88.08~  
 TOWN ACE  
 front タウンエースノア CR30G,37G 88.08~  
 TOWN ACE NOAH

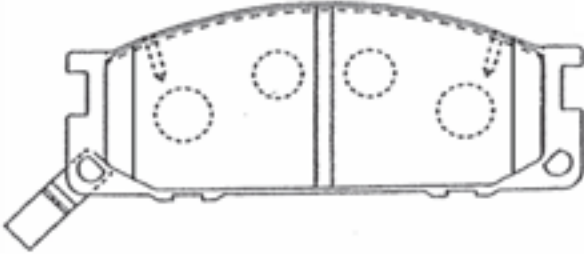
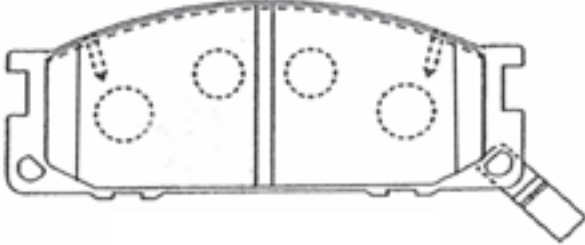
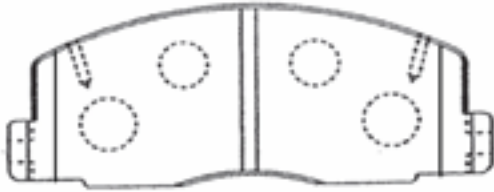

インナ W : 128.3 H : 52.0 T : 15.5  
 アウタ W : 136.7 H : 55.0 T : 15.5

**A1N085** エミナ,ルシータ CXR11G,TCR10G 90.10~  
 EMINA,LUCIDA  
 front ライト,タウンエース CM85 99.06~  
 LITE,TOWN ACE

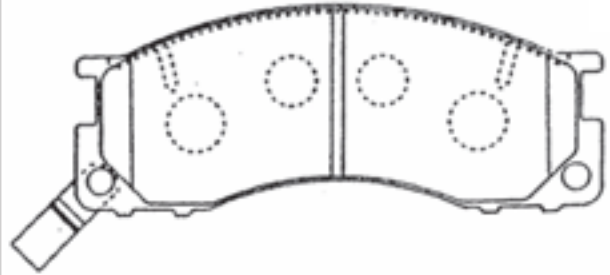
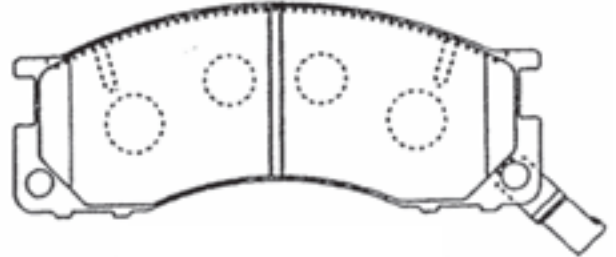
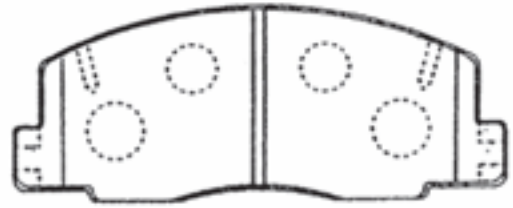

インナ W : 128.3 H : 52.0 T : 15.5  
 アウタ W : 136.7 H : 55.0 T : 15.5



**A1N092** エスティマ  
ESTIMA  
エミーナ、ルシーダ  
EMINA,LUCIDA  
front

TCR10W,20W 93.02~  
CXR10G,20G 93.08~

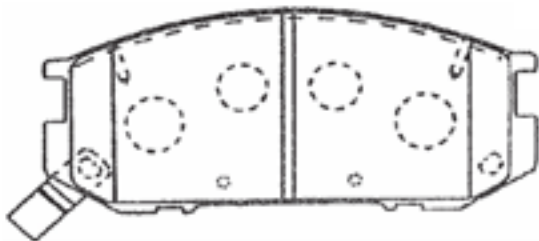
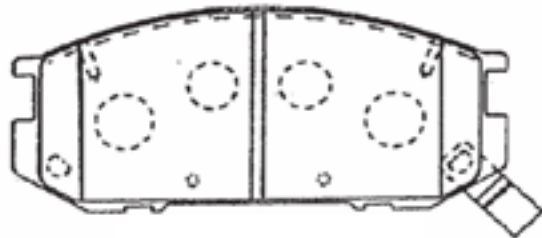
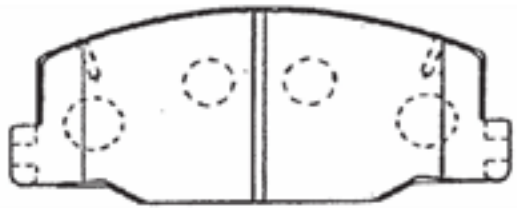

インナ W: 128.2 H: 55.0 T: 15.5  
アウト W: 126.7 H: 57.0 T: 15.5

**A1N093** エスティマ  
ESTIMA  
エミーナ、ルシーダ  
EMINA,LUCIDA  
front

TCR10W,20W 92.09~  
CXR10G,20G 93.08~

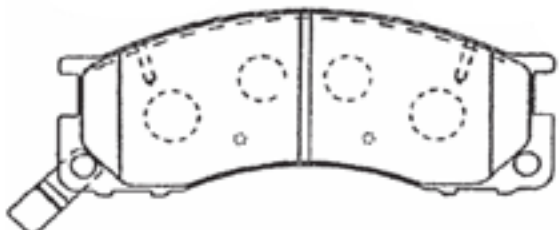
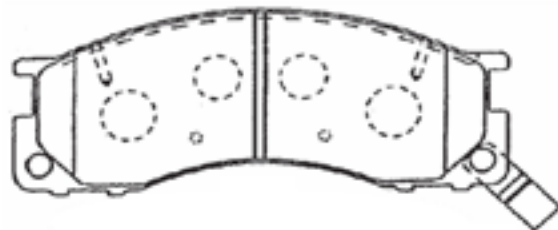

インナ W: 128.4 H: 52.0 T: 15.5  
アウト W: 136.7 H: 55.0 T: 15.5

**A1N096** エスティマ  
ESTIMA  
ライトタウンエース、ア  
LITE,TOWN ACE  
front

TCR10W,20W 96.08~  
SR40G,50G 96.10~

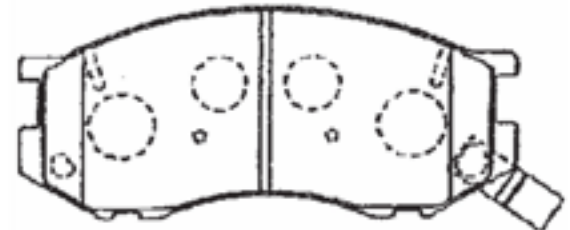
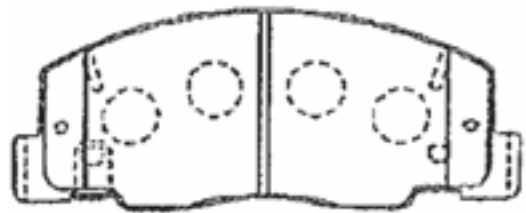

インナ W: 128.3 H: 52.0 T: 15.5  
アウト W: 126.8 H: 54.9 T: 15.5

**A1N097** カムリ、グラシア  
CAMRY,GRACIA  
ナディア  
NADIA  
front

SXV25,25W 97.06~  
SXN10,10H 98.07~

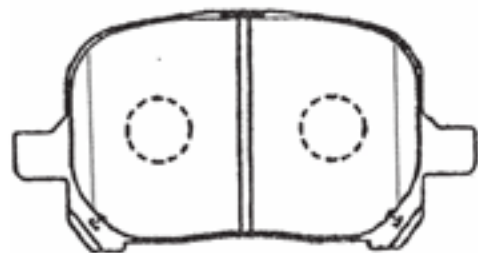

W: 116.7 H: 59.0 T: 17.0

**A1N100** ダイナトヨエース  
DYNA,TOYOACE BU105,145,107 97.08~  
front XZU362,362A,372 99.07~

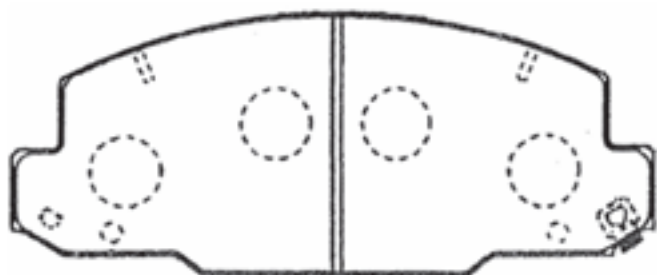
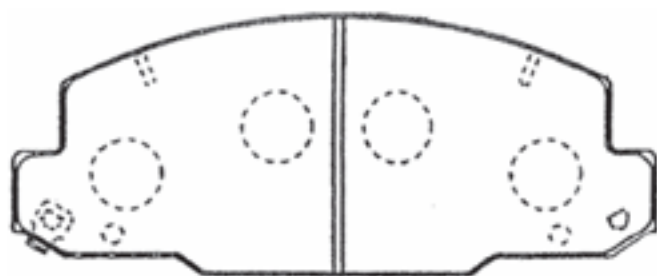

W : 166.4 H : 67.0 T : 20.0

**A1N101** エスティマT/L  
ESTIMA T/L MCR30W,40W 99.12~  
front ACR30W,40W 00.02~

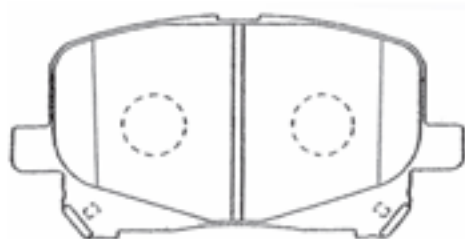

W : 116.8 H : 59.5 T : 17.0

**A1N103** クルーガーV  
KLUGER V ACU20W,25W 00.11~  
front MCU20W,25W 00.11~

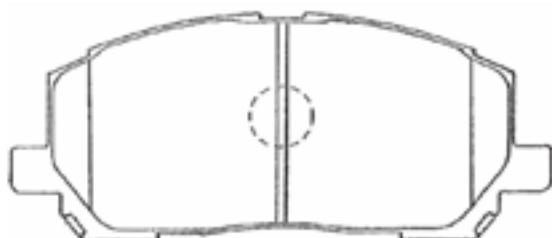

W : 138.9 H : 59.5 T : 18.7

**A1N105** イブサム  
IPSUM ACM21W,26W 01.05~  
front グェルク ZZE136,138 02.05~  
VOLTZ

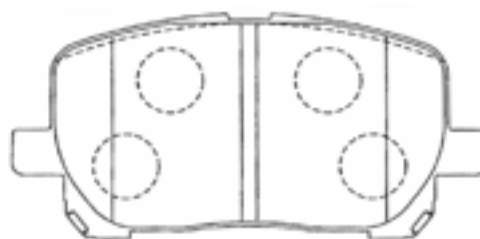

W : 123.0 H : 59.5 T : 17.0

**A1N106** ウィンダム  
WINDOM MCV30 01.07~  
front アルファード ANH10W,MNH10W 02.05~  
ALPHARD

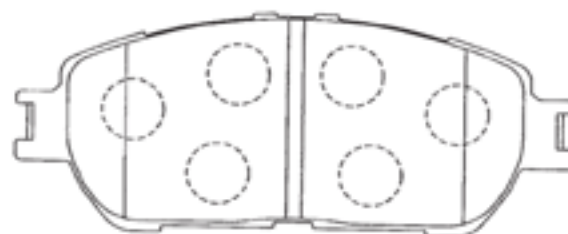

W : 143.5 H : 58.5 T : 16.0

**A1N110** ハリアー  
HARRIER ACU30W,35W 03.02~  
front MCU30W,31W 03.02~

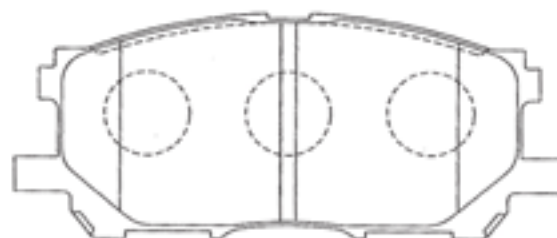

W : 140.8 H : 59.4 T : 17.0

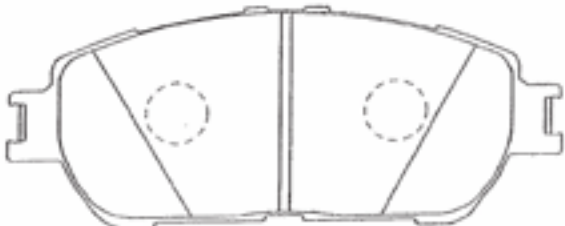
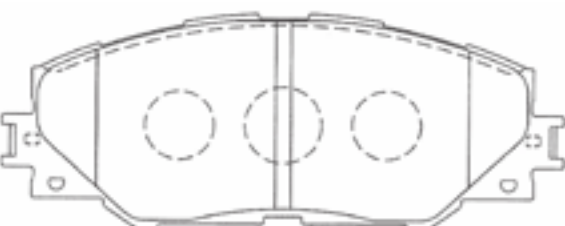
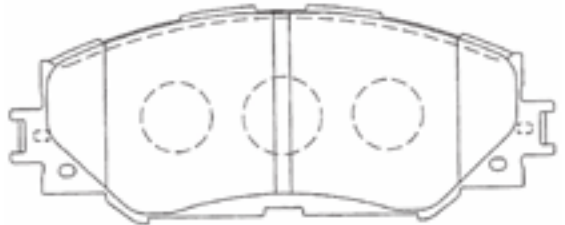
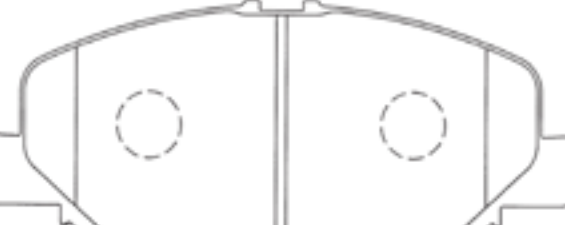
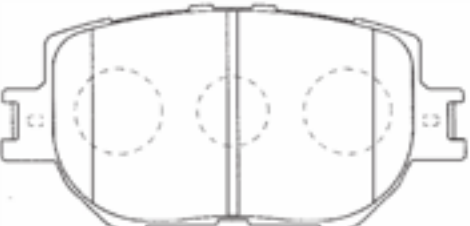
<p><b>A1N115</b> <small>アバロン</small> AVALON シエナ SIENNA</p> <p>GSX30 05.01~</p> <p>front</p>  <p>W : 143.5 H : 58.5 T : 17.5</p>	<p><b>A1N129</b> <small>RAV4</small> CAMRY</p> <p>ACA31W,36W ACV40</p> <p>05.11~ 06.01~</p> <p>front</p>  <p>W : 144.6 H : 57.0 T : 17.5</p>
<p><b>A1N128</b> <small>オーリス,アテン</small> AURIS,AXIO フィールダー FIELDER</p> <p>NZE141,144 NZE141G,144G</p> <p>06.10~ 06.10~</p> <p>front</p>  <p>W : 139.1 H : 55.6 T : 17.5</p>	<p><b>A1N139</b> <small>エスティマ</small> ESTIMA</p> <p>ACR5#,GSR5#</p> <p>06.01~</p> <p>front</p>  <p>W : 147.7 H : 60.9 T : 18.0</p>
	<p><b>A1N140</b> <small>クラウン</small> CROWN</p> <p>GRS180,182,183</p> <p>03.12~</p> <p>front</p>  <p>W : 117.6 H : 58.5 T : 17.5</p>

**A1N144** ランドクルーザー-100 HDJ101、UZJ100 98.01~  
 front LAND CRUISER100

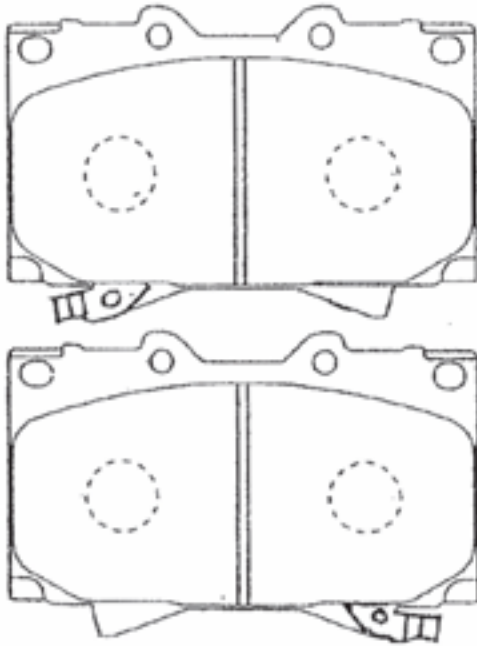

W : 119.5 H : 78.0 T : 17.5

**A1N154** カムリ CAMRY ACV40、45 06.01~  
 front

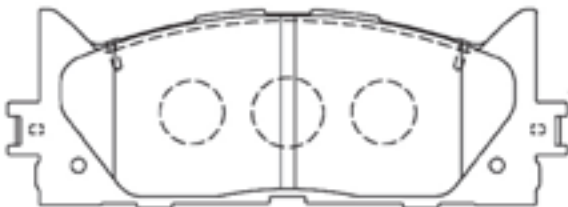

W : 157.6 H : 55.5 T : 17.5

**A1N155** ヴィッツ VITZ KSP90、  
 front NCP91、95 05.01~

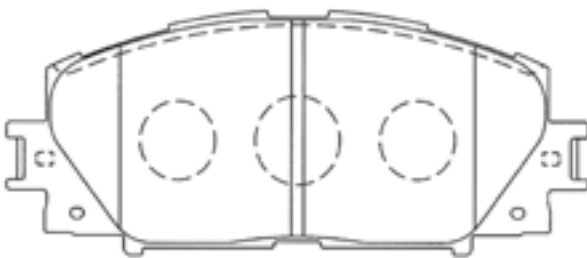

W : 123.8 H : 49.6 T : 17.5

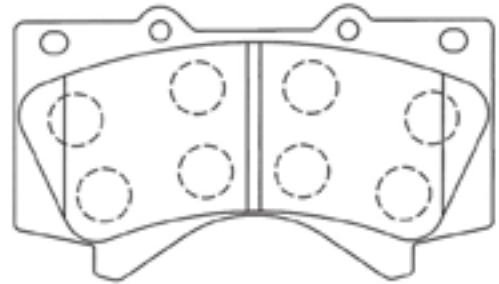
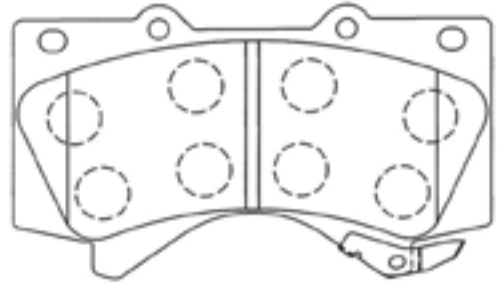
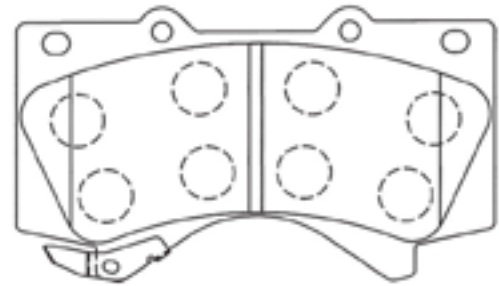

**A1N156** ランドクルーザー-200 UZJ200W 07.08~  
 front LAND CRUISER200

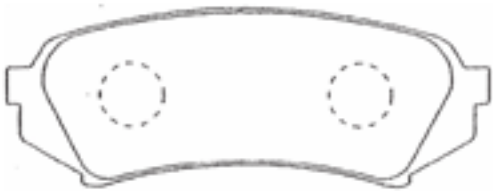
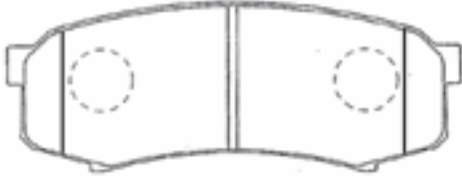
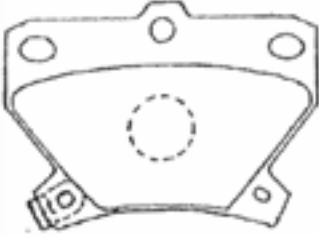
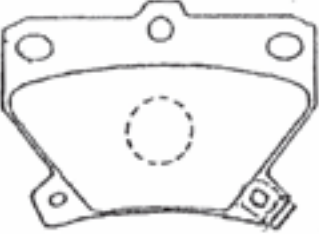
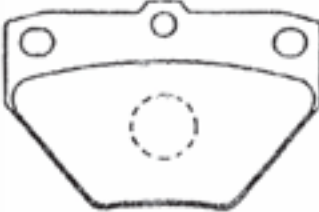
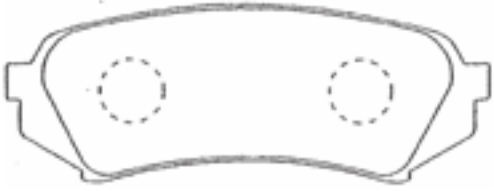
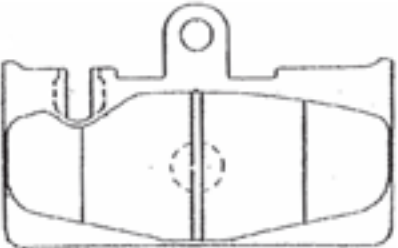
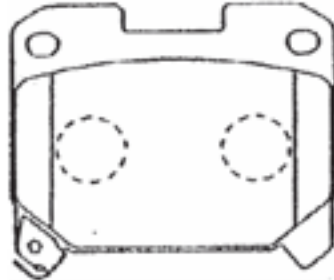
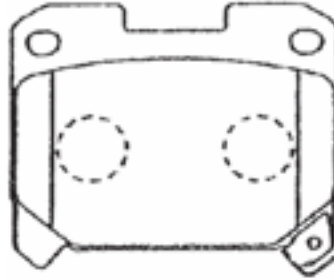

W : 143.73 H : 83.2 T : 17.9

<p><b>A2N004</b> ランドクルーザー LAND CRUISER rear</p> <p>HDJ101,UZJ100 98.01~</p>  <p>W : 123.0 H : 45.1 T : 17.5</p>	<p><b>A2N012</b> ランドクルーザー LAND CRUISER ハイラックスサーフ HILUX SURF rear</p> <p>RZJ120W,215W 02.09~ RZN210W,215W 02.11~</p>  <p>W : 116.0 H : 43.6 T : 15.5</p>
<p><b>A2N007</b> ヴェイツ VITZ ランクス,アレックス RUNX,ALLEX rear</p> <p>NCP13 00.10~ ZZE123 01.01~</p>    <p>W : 78.5 H : 55.1 T : 14.0</p>	<p><b>A2N022</b> ランドクルーザープラド LAND CRUISER PRADO rear</p> <p>LJ71G,78G,78W 90.04~ RZJ90W,85W 96.04~</p>  <p>W : 123.0 H : 45.1 T : 17.5</p>
<p><b>A2N010</b> セルシオ CELSIOR セルシオ CELSIOR rear</p> <p>UCF30,31 00.08~</p>  <p>W : 96.2 H : 62.0 T : 15.0</p>	<p><b>A2N027</b> セリカ CELICA スーフラ SUPRA rear</p> <p>ST205 94.02~ JZA80 94.08~</p>   <p>W : 80.9 H : 69.0 T : 16.0</p>

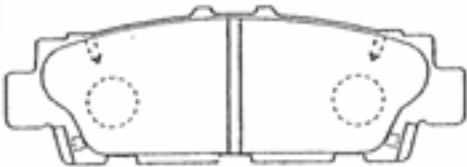
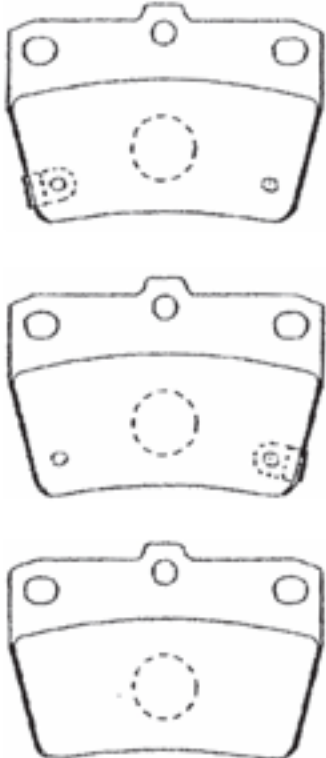
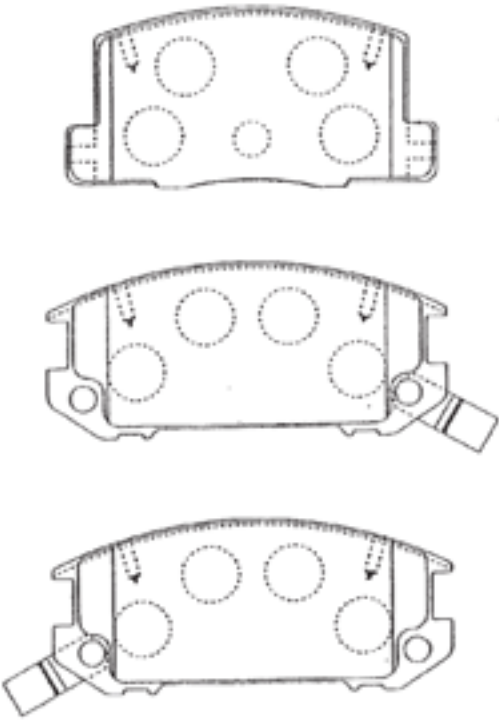

<p><b>A2N030</b> マークII,クレスタ MARK II,CRESTA チェイサー CHASER</p> <p>GX100,LX100 96.09~ SX100,JZX100 96.09~</p> <p>rear</p>  <p>W : 116.0 H : 40.0 T : 17.5</p>	<p><b>A2N042</b> セルシオ CELSIOR</p> <p>UCF10,11 89.11~</p> <p>rear</p>  <p>W : 117.0 H : 40.0 T : 15.5</p>
<p><b>A2N031</b> RAV4</p> <p>SXA10W,11W 97.09~</p> <p>rear</p>  <p>W : 78.5 H : 54.2 T : 14.0</p>	<p><b>A2N044</b> MR2 SW20 89.12~ MR-S ZZW30 99.10~</p>  <p>インナ W : 98.6 H : 47.3 T : 16.0 アウト W : 106.9 H : 47.0 T : 15.5</p>
<p><b>A2N040</b> スターレット STARLET サイラス CYNOS</p> <p>EP82,91 89.12~ EL44(β) 91.01~</p> <p>rear</p>  <p>W : 87.0 H : 38.0 T : 12.5</p>	<p><b>A2N047</b> エスティマ ESTIMA エミナ,ルシダ EMINA,LUCIDA</p> <p>TCR11W,21W 90.02~ CXR10G,TCR10G 93.08~</p> <p>rear</p>  <p>W : 119.7 H : 42.5 T : 15.5</p>

**A2N057** マークII,チェイサー  
MARK II, CHASER  
クラウン  
CROWN  
rear  
SX90,GX90,LX90 92.10~  
GS151,LS151 95.12~

W : 106.1 H : 38.3 T : 17.5

**A2N059** スーパ  
SUPRA  
マークII, クレスタ  
MARK II,CRESTA  
rear  
JZA80 93.05~  
JZX90,93,100 95.09~

W : 122.0 H : 41.0 T : 15.5

**A2N058** セルシオ  
CELSIOR  
センチュリー  
CENTURY  
rear  
UCF10,11,20,21 92.08~  
GZG50 97.04~

W : 122.0 H : 41.0 T : 15.5

**A2N066** ウィンダム  
WINDOM  
カムリ,グラシア  
CAMRY,GRACIA  
rear  
MCV20,21 99.08~  
SXV20,20W 99.08~

W : 83.1 H : 38.5 T : 15.0

**A2N069** エスティマ T/L  
ESTIMA T/L  
イプサム  
IPSUM  
rear  
RCR30W 99.12~  
ACM21W,26W 01.05~

W : 112.5 H : 42.9 T : 16.5

DRAWINGS

<b>A2N076</b>	カローラレビン COROLLA LEVIN	AE86	83.05~
	スプリンター SPRINTER	AE86	83.05~

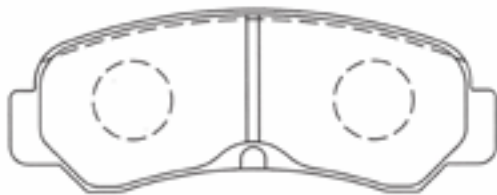

<b>A2N080</b>	クラウン CROWN	GS130,JZS131	87.09~
	スーパー SUPRA	GA70,JZA70	88.08~



W : 125.3 H : 42.3 T : 14.5

<b>A2N081</b>	カリーナ CARINA	AT171,175	88.05~
	セリカ CELICA	ST182,183,185	89.09~



W : 107.6 H : 42.5 T : 15.0

<b>A2N084</b>	プリスト ARIST	JZS147	91.10~
	クラウン CROWN	JZS147,149	91.10~

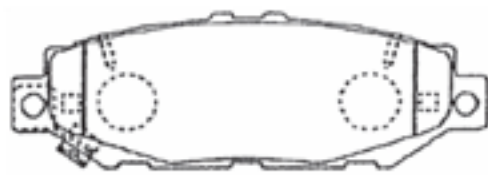



W : 122.0 H : 41.0 T : 15.5



<b>A2N094</b>	307EXIV CORONA EXIV	ST202,203,205	95.08~
	セリカ CELICA	ST202,202C,203	95.08~

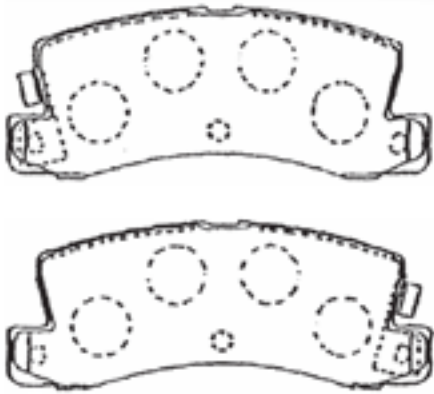
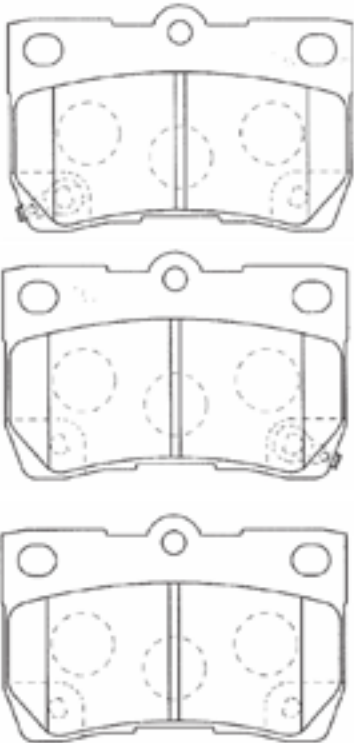
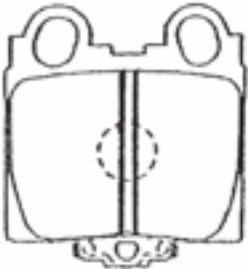
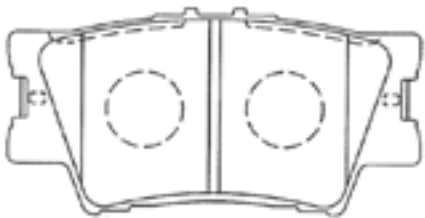
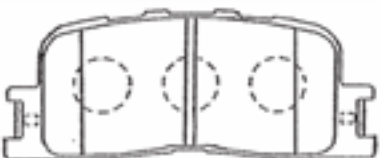

W : 107.6 H : 42.5 T : 15.0

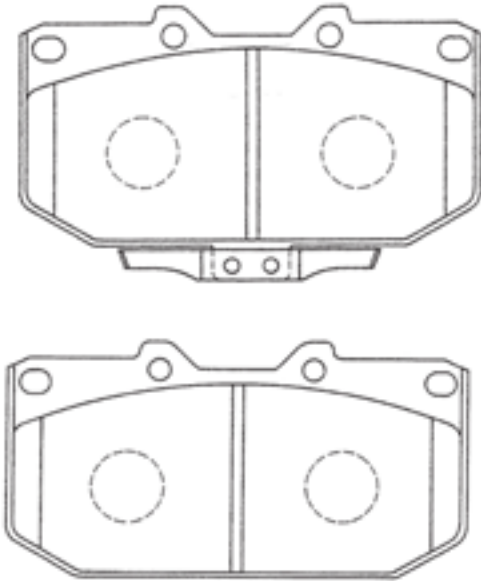
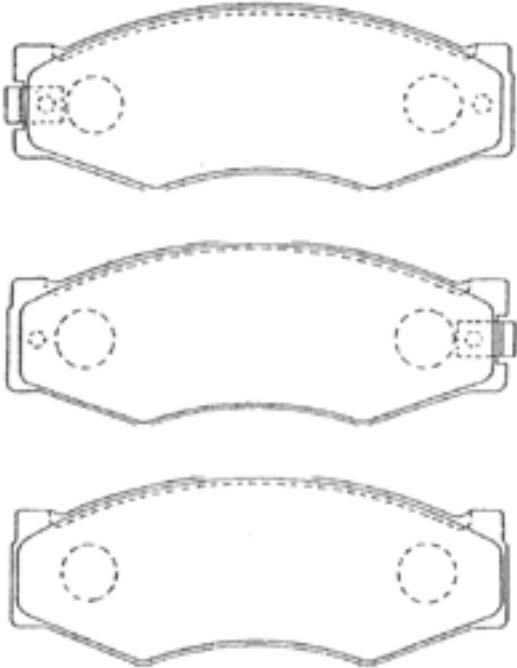

<p><b>A2N095</b> レビン,セレス LEVIN, CERES スプリンター,カリブ SPRINTER,CARIB</p> <p>AE101,111 95.05~ AE111G 96.05~</p> <p>rear</p>  <p>W : 107.6 H : 42.5 T : 15.0</p>	<p><b>A2N118</b> クラウン CROWN</p> <p>GRS180,182,183 03.12~</p> <p>rear</p>  <p>W : 88.0 H : 58.1 T : 15.5</p>
<p><b>A2N099</b> アルテzza ALTEZZA マークII MARK II</p> <p>SXE10,GXE10 98.10~ GX110,115 00.10~</p> <p>rear</p>  <p>W : 57.2 H : 63.6 T : 15.5</p>	<p><b>A2N130</b> RAV4 カムリ CAMRY</p> <p>ACA31W,36W 05.11~ ACV40 06.01~</p> <p>rear</p>  <p>W : 96.7 H : 49.2 T : 15.5</p>
<p><b>A2N104</b> クルガーV KLUGER V ワイッシュ WISH</p> <p>ACU20W 00.11~ ZNE10G,ANE10G 03.01~</p> <p>rear</p>  <p>W : 93.0 H : 37.9 T : 16.0</p>	<p><b>A2N159</b> ランドクルーサー-200 LAND CRUISER-200</p> <p>UZJ200W 07.08~</p> <p>rear</p>  <p>W : 116.2 H : 44.63 T : 17.5</p>
<p><b>A2N111</b> ハリアー HARRIER</p> <p>ACU30W,35W 03.02~ MCU30W,31W 03.02~</p> <p>rear</p>  <p>W : 101.8 H : 43.9 T : 15.5</p>	

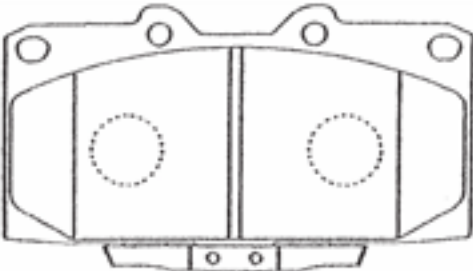
<p><b>B1N002</b> シルビア SILVIA S15 99.01~ front</p>  <p>W : 119.3 H : 61.9 T : 14.5</p>	<p><b>B1N004</b> セドリック CEDRIC, GLORIA ハネット VANETTE TY31, MJY31 87.06~ front KHGNC22 87.06~</p>  <p>W : 130.0 H : 48.5 T : 17.0</p>
<p><b>B1N003</b> アトラス ATLAS キャラバンホミー CARAVAN HOMOY BF22, BGF22, UF22 86.11~ front CHGE24, VHE24 88.10~</p>  <p>W : 130.0 H : 48.5 T : 17.0</p>	<p><b>B1N006</b> スカイライン SKYLINE シルビア SILVIA HCR32, HNR32 89.05~ front S14, CS14(ターボ) 89.10~</p>  <p>W : 119.3 H : 61.9 T : 14.5</p>

**B1N009** サニー  
SUNNY  
ハルサー  
PULSAR  
front  
B12,FB12  
N13,FN13  
85.09~  
86.05~

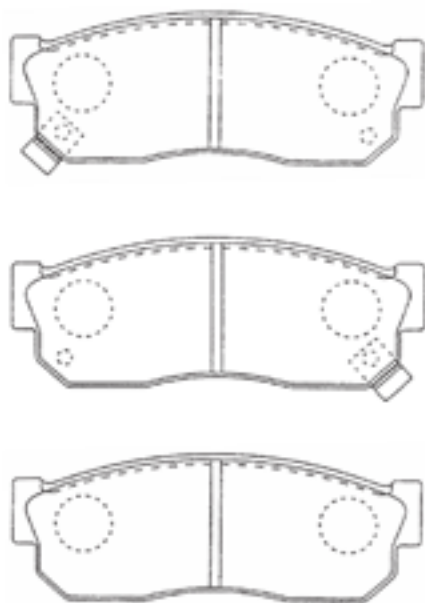

W : 108.6 H : 40.0 T : 16.0

**B1N011** キャラバンホミー  
CARAVAN HOMOY  
ミストラル  
MISTRAL  
front  
KSGE24,AEGE24  
R20,KR20  
88.10~  
94.02~

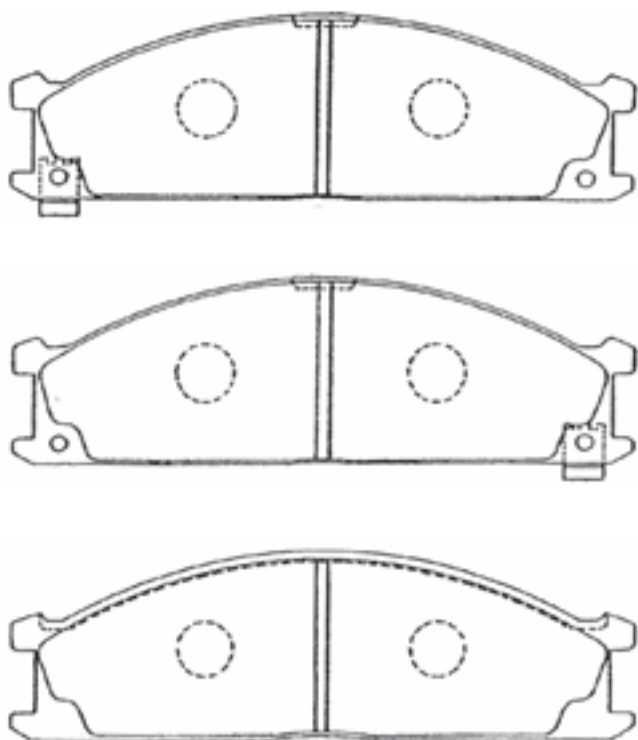

W : 160.6 H : 49.5 T : 17.0

**B1N017** プレセア  
PRESEA  
ハルサー  
PULSAR  
front  
R10,PR10  
N14,FN14,SN14  
90.06~  
90.08~

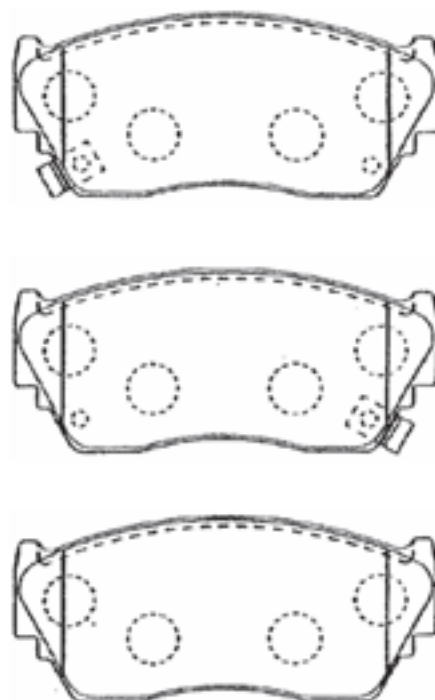

W : 108.6 H : 48.0 T : 16.5

**B1N018** サニー  
SUNNY  
ハルサー  
PULSAR  
front  
HB13,HNB13  
HN14  
90.01~  
90.08~

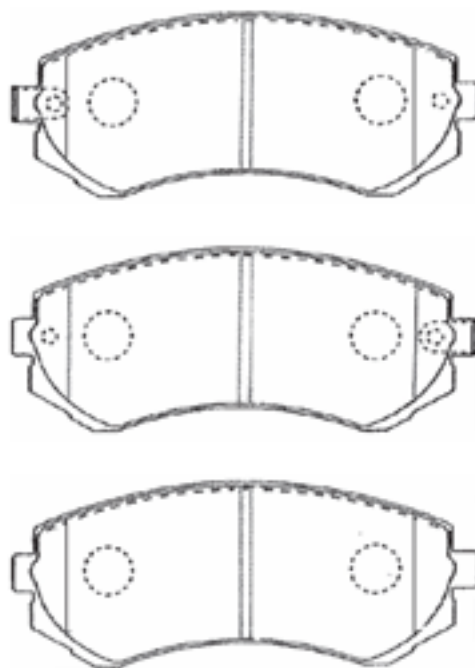

W : 121.0 H : 50.3 T : 16.0

**B1N028** セト、グロ CEDRIC, GLORIA PY32, Y33, MY33 91.06~  
 フレーサー、リハティ PRAIRE, LIBERTY PM12, PNM12 98.11~  
 front

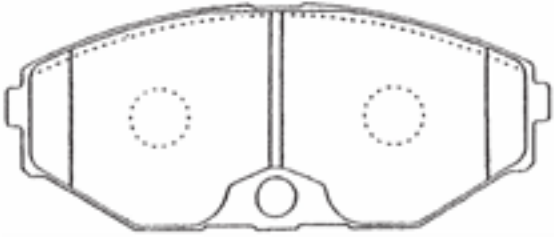
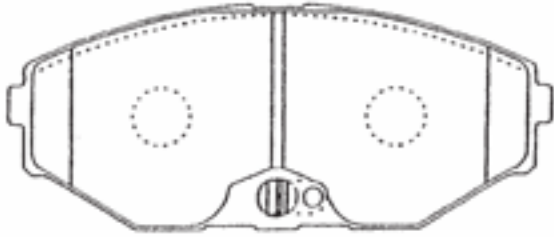

W : 139.1 H : 59.5 T : 15.0

**B1N031** アトラス ATLAS SK2F23, SK4F23 97.08~  
 エルフ ELF ASR2F23 99.06~  
 front



W : 142.0 H : 54.5 T : 18.0

**B1N036** シーマ CIMA HF50, GF50 01.02~  
 フーガ FUGA Y50, PY50, PNY50 04.10~  
 front

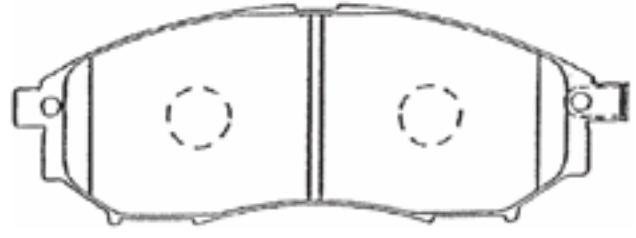
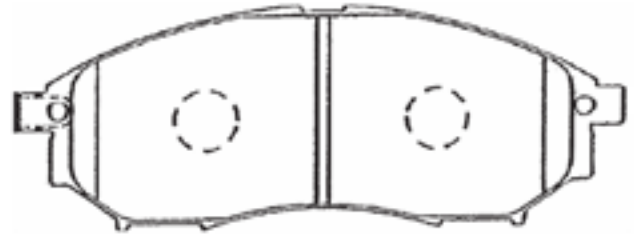

W : 157.0 H : 58.6 T : 16.0

**B1N037** キューブ CUBE AZ10, ANZ10 99.11~  
 イクストレイル X-TRAIL PNT30 00.09~  
 front

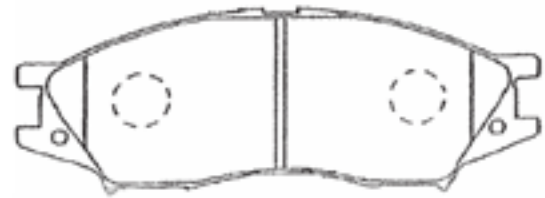
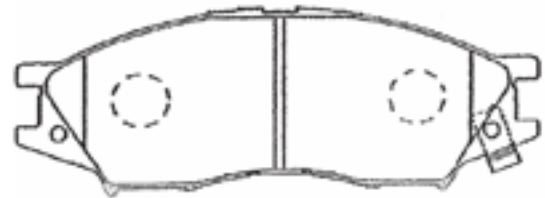
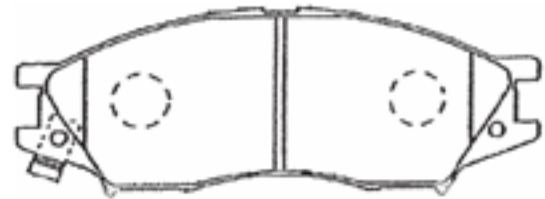

W : 135.0 H : 48.5 T : 15.0

**B1N039** セフィロ  
CEFIRO  
ティノ  
TINO  
A33,PA33  
V10,HV10  
98.12~  
98.12~

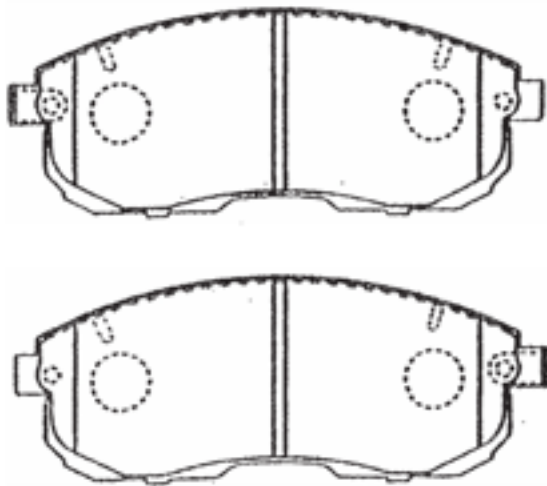

W : 137.0 H : 53.0 T : 17.0

**B1N062** テラノレグラス  
TERRANO,REGULUS  
プレサージュ  
PRESAGE  
JRR50,JLR50  
U30,NU30,VU30  
96.08~  
98.06~

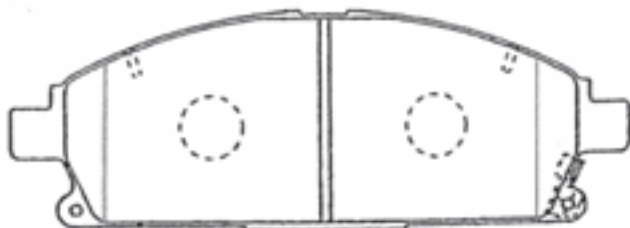
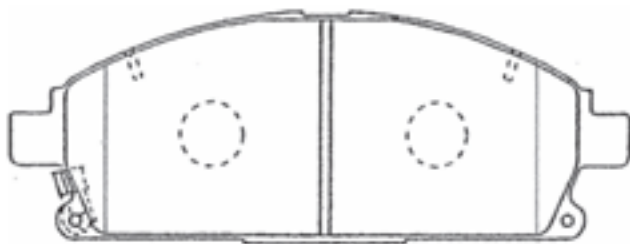

W : 158.9 H : 56.0 T : 16.5

**B1N079** ムラノ  
MURANO  
TZ50,  
PZ50,PNZ50  
04.09~

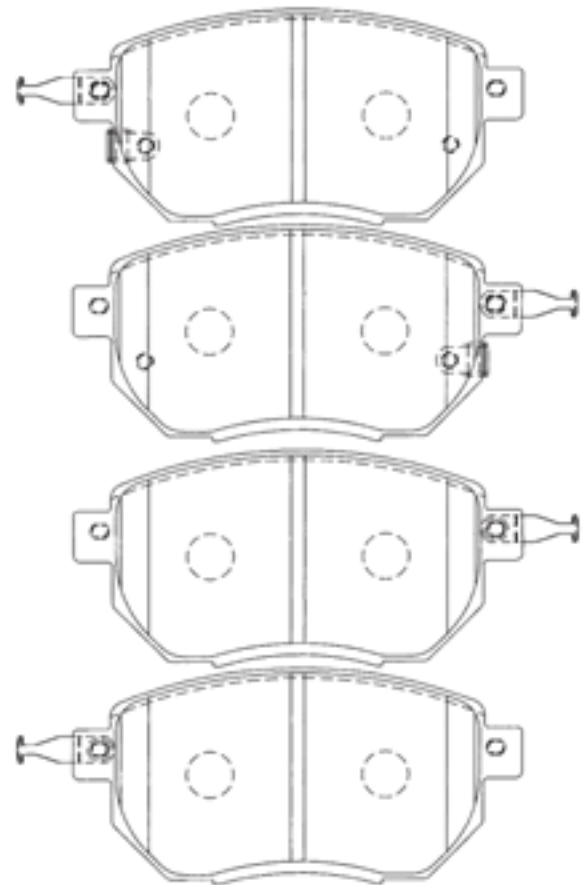

W : 135.6 H : 66.0 T : 15.5



**B2N016** シルビア PS13,KS13,S13,14 88.05~  
 rear SILVIA 180SX RS13,RPS13 91.01~



W : 85.3 H : 42.5 T : 14.0

**B2N026** マーチ MARCH K11,HK11 92.01~  
 rear フレオ PLEO RA1 98.10~

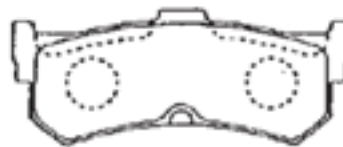
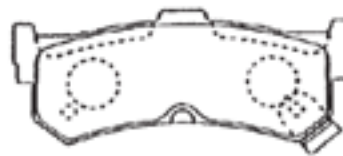
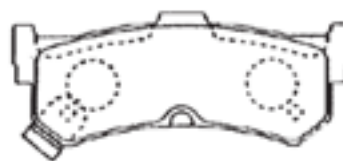

W : 85.4 H : 34.8 T : 13.0

**B2N029** サニー SUNNY FB14,EB14,HB14 94.01~  
 rear フレセア PRESEA R11,PR11,HR11 95.01~



W : 99.5 H : 40.0 T : 15.0

**B2N022** セフィロ CEFIRO A32,PA32,WA32 94.08~  
 rear ティーノ TINO V10,HV10 98.12~

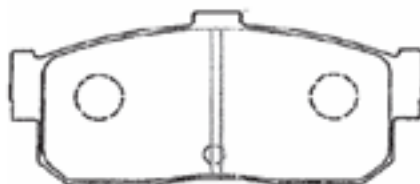
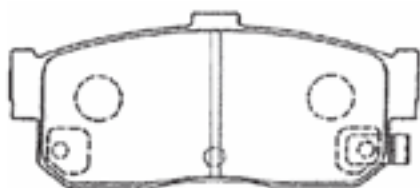
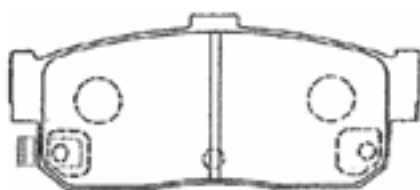

W : 105.3 H : 46.5 T : 16.0

**B2N040** セフィーロ  
CEFIRO  
ウイングロード  
WINGROAD  
rear

A33,PA33  
WPY11

00.12~  
01.03~

W : 105.5 H : 43.0 T : 16.0

**B2N050** テラノ  
TERRANO  
rear

WBVD21,LBYD21

87.10~

W : 114.8 H : 45.0 T : 16.0

**B2N045** シーマ  
CIMA  
スカイライン  
SKYLINE  
rear

FPY31,FPAY31  
HR32,HCR32

88.01~  
89.05~

W : 98.8 H : 34.7 T : 15.3

**B2N053** スカライン  
SKYLINE  
フェアレディZ  
FAIRLADY Z  
rear

HCR32,ER33  
GZ32,CZ32

89.05~  
89.07~

W : 73.3 H : 54.9 T : 16.0

DRAWINGS

**B2N056** スカイライン SKYLINE ステージア STAGEA  
 rear HR32,HCR32 90.04~  
 WHC34,WGC34 96.09~



W : 98.9 H : 34.7 T : 15.0

**B2N064** ALTIMA  
 rear V35, HV35, NV35 01.06~  
 E51, NE51 02.05~

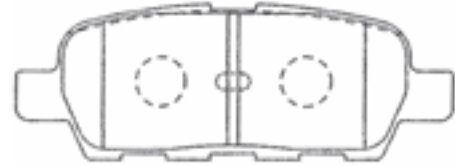
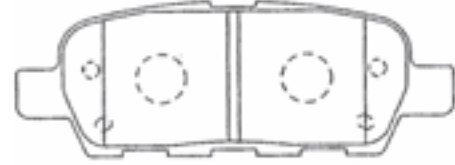
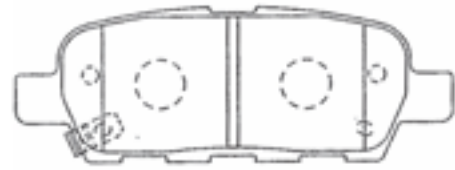

W : 105.4 H : 38.0 T : 14.5

**B2N057** シーマ CIMA ステージア STAGEA  
 rear FPY32,FHY33 93.09~  
 WGNC34 98.08~



W : 108.6 H : 35.2 T : 15.0



**C1N004** シビック CIVIC CR-X  
 front  
 FE1,2 EF6  
 87.07~ 87.07~

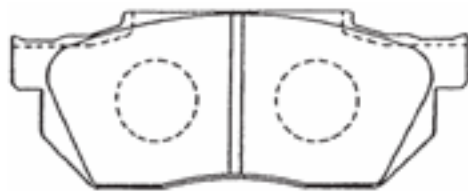

W : 116.0 H : 45.5 T : 15.0

**C1N016** シビック CIVIC ストリーム STREAM  
 front  
 EG4,5,6,EU1,2 RN1,2  
 00.09~ 00.10~

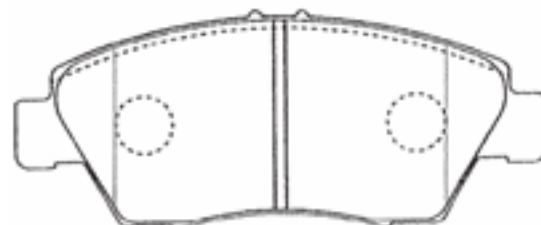
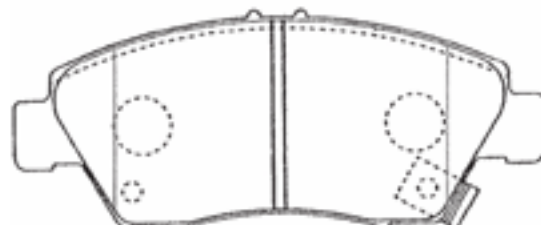
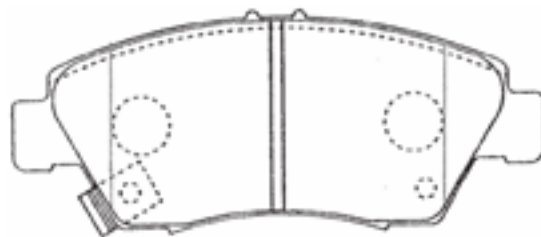

W : 136.5 H : 58.2 T : 16.5

**C1N013** CR-X, シビック CR-X, CIVIC レジェンド LEGEND  
 front  
 EF8,9 KA3,5,6  
 89.08~ 88.10~

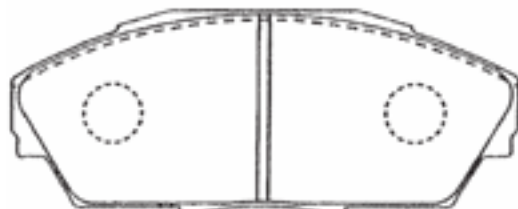
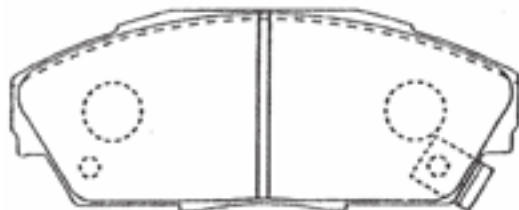
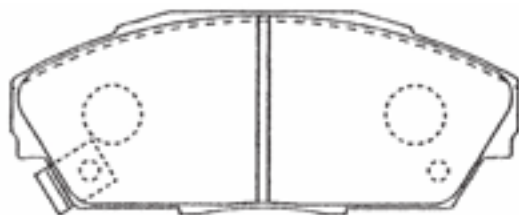

W : 129.0 H : 53.0 T : 17.0

**C1N018** フォード/トルネオ ACCORD.TORNEO オデッセイ ODYSSEY CF4,5,CL2,3,CD6 93.09~ RA1,2,3,4 94.10~  
front

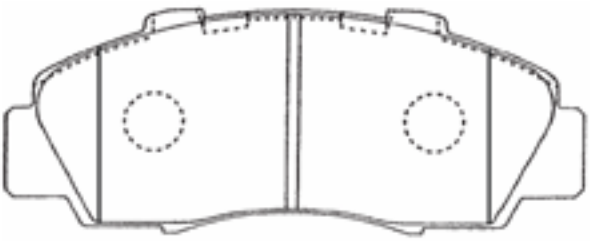
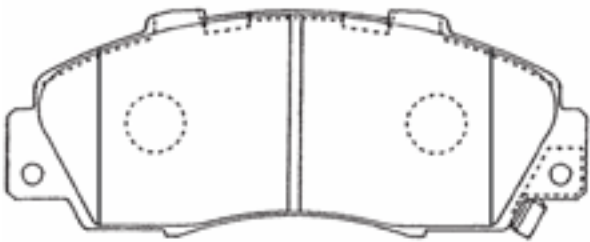
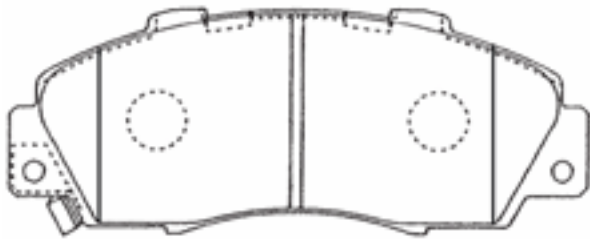

W : 148.7 H : 57.5 T : 17.5

**C1N020** シビックフェリオ CIVIC FERIO シビック CIVIC EG7,8,EH1,EK2,3 91.07~ EG4,5,EK2,3 91.09~  
front

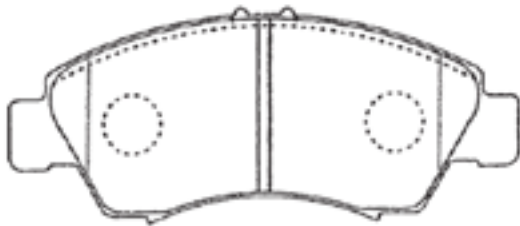
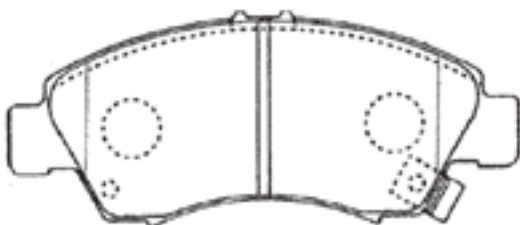
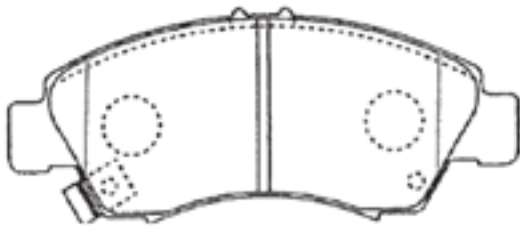

W : 131.5 H : 54.8 T : 15.0

**C1N024** インテグラ INTEGRA オルティア ORTHIA DC1,2,DB6,7,8 93.05~ EL1,2,3 96.03~  
front

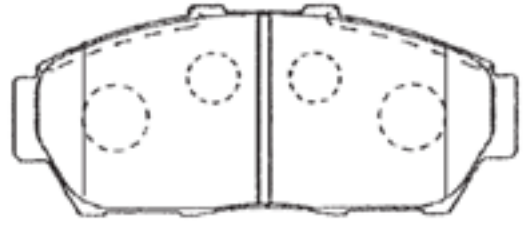
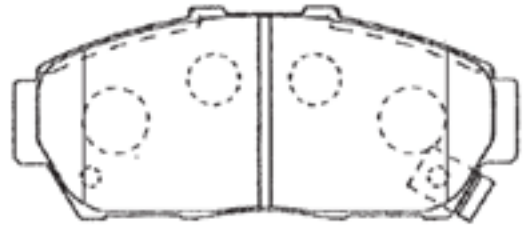
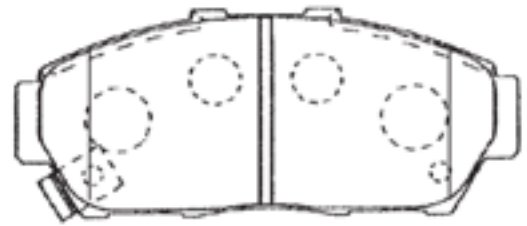

W : 129.1 H : 54.7 T : 16.5

**C1N026** フォード/トルネオ ACCORD.TORNEO オデッセイ ODYSSEY CL1 00.06~ RA6,7,8,9 99.12~  
front

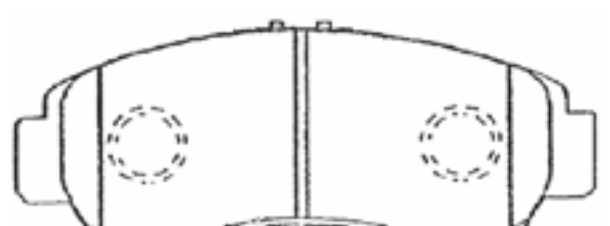
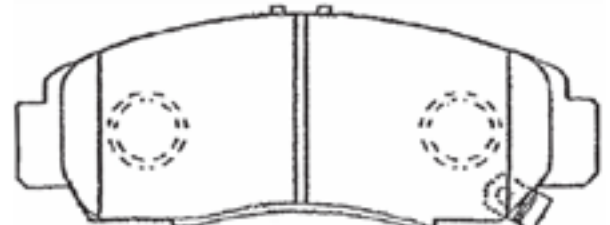
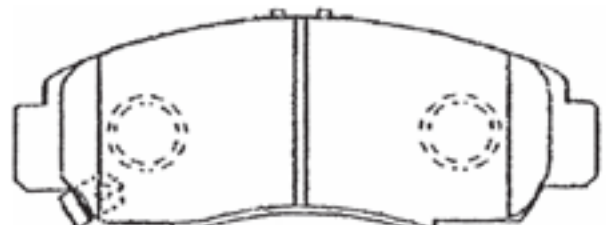

W : 148.7 H : 58.2 T : 17.0

**C1N030** ストリーム  
STREAM  
エクイナス  
EDIX      RN3,4      00.10~  
front      BE2,3,4      04.07~

W : 148.7 H : 59.7 T : 15.5

**C1N033** フォード  
ACCORD  
インテグラ  
INTEGRA      CA2,3,5      87.05~  
front      DA5,7      89.04~

W : 127.8 H : 48.5 T : 15.0

**C1N031** CR-V  
CR-V      RD5, 6      01.09~  
front           03.04~

W : 141.7 H : 56.8 T : 17.0

**C1N034** フォード  
ACCORD      CD7,CE1      94.02~  
front

W : 137.8 H : 52.5 T : 18.5

C1N035 CR-V RD1,2 95.10~

front

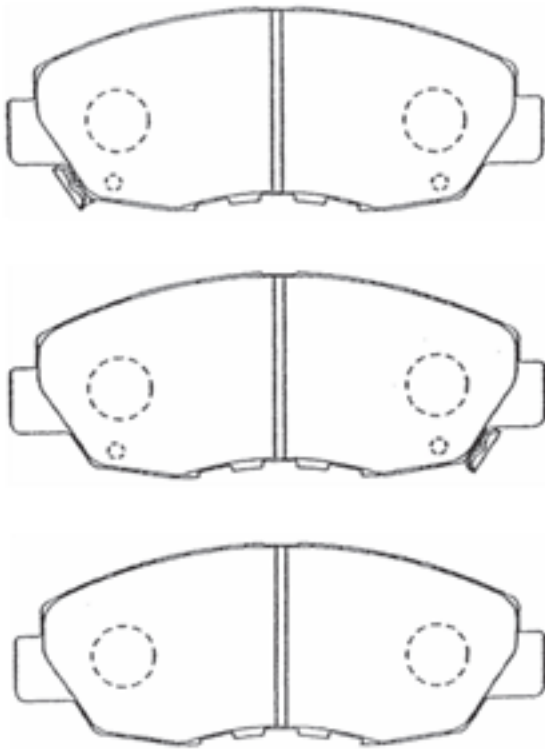

W : 137.8 H : 52.5 T : 17.0

C1N042 エリシオン ELYSION RR1,2,3,4 04.05~

front

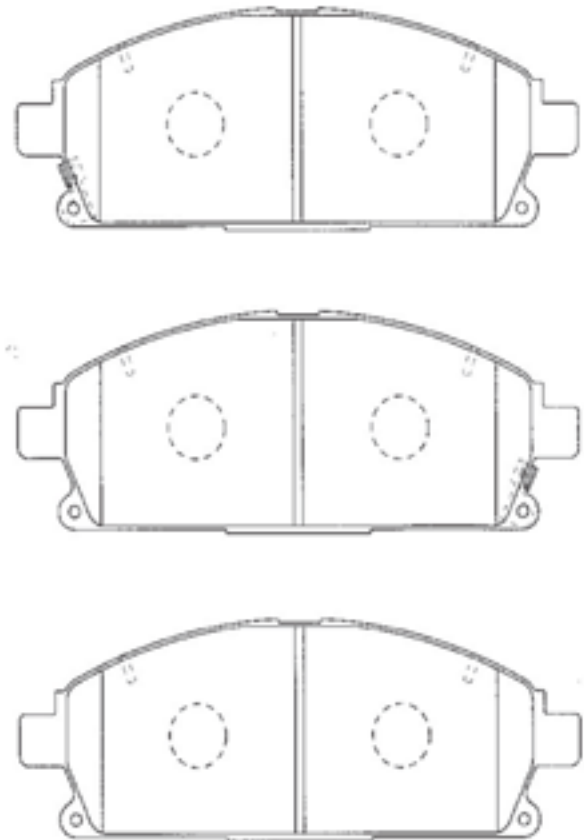

W : 158.9 H : 56.0 T : 16.5

C1N036 シビッククーペ CIVIC COUPE EJ7 96.01~

front

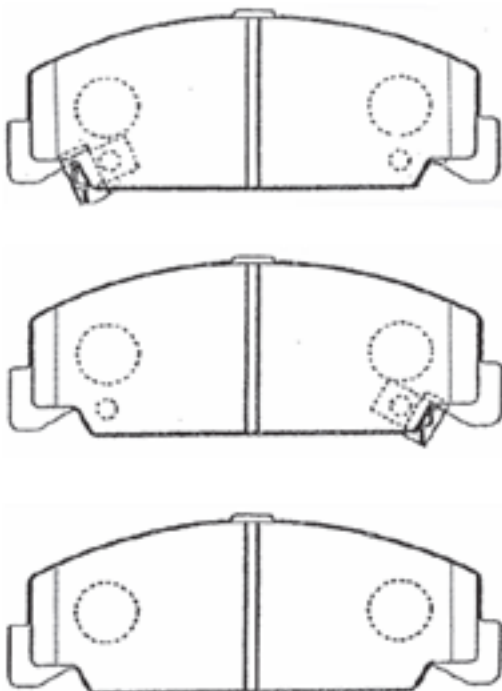

W : 127.5 H : 48.0 T : 15.0

C1N044

RL  
RL

KB1

04.10~

front

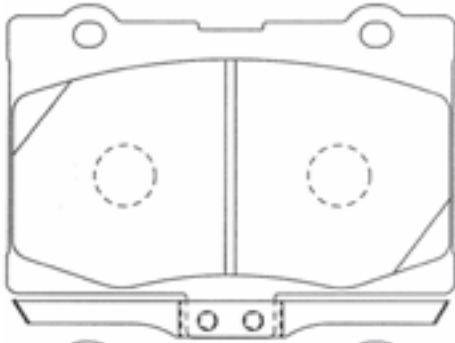

インナ右

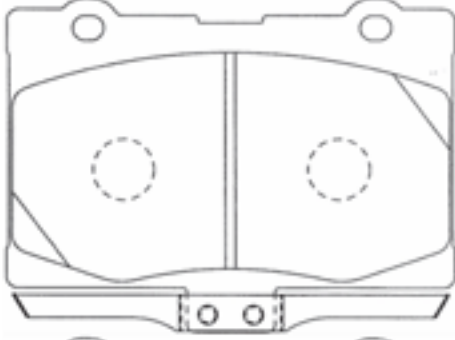

インナ左

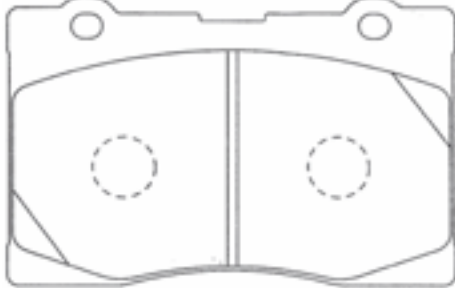

アウト右

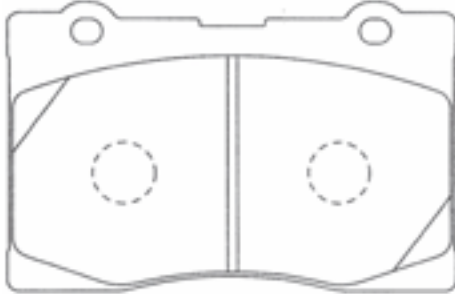

アウト左

W : 116.6 H : 76.2 T : 16.0

C1N048

CR-V/オデッセイ  
CR-V/ODYSSEY

RE3、4

06.10~

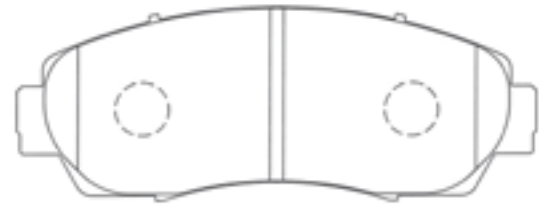
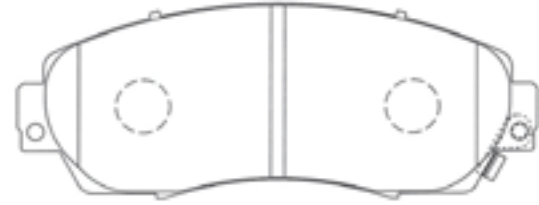
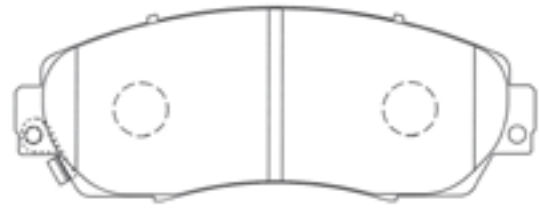

W : 154.7 H : 58.5 T : 18.0

DRAWINGS

**C2N015** プレリュード  
PRELUDE  
インテグラ  
INTEGRA

BA8,9,BB1  
DC2,8

91.09~  
98.01~

rear

W : 89.0 H : 48.0 T : 15.0

**C2N022** シビックフェリオ  
CIVIC FERIO  
インテグラ  
INTEGRA

EG8,9,EJ3,EK3,4  
DA5,6,7,DB1,6,7

91.09~  
91.10~

rear

W : 89.0 H : 36.5 T : 12.6

**C2N021** オディッセイ  
ODYSSEY  
ステップワゴン  
STEP WGN







RA1,2,3,4,5,6,8,9  
RF1,2

94.10~  
96.05~

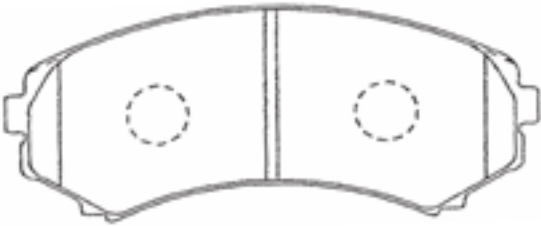
rear

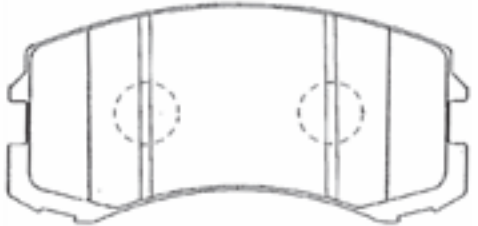
W : 89.0 H : 48.0 T : 15.0

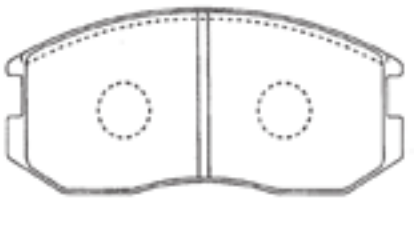

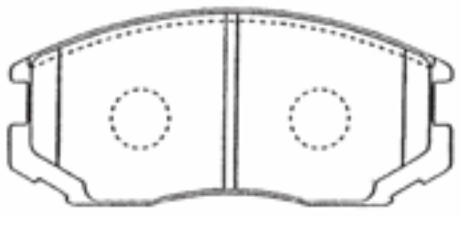
<p><b>D1N003</b> ハジロ PAJERO V63W,65W,68W 99.10~ front</p>  <p>W : 131.9 H : 58.5 T : 15.5</p>	<p><b>D1N014</b> ミラージュ,ランサー MIRAGE,LANCER リベロ,カーゴ LIBERO,CARGO CA1A,2A,CB1A 91.08~ front CB2W,1V,2V 92.04~</p>  <p>W : 114.0 H : 49.8 T : 15.0</p>
<p><b>D1N004</b> ランサーセテイフ LANCER ミラージュディンゴ MIRAGE DINGO CS5A,5W 00.05~ front CQ1A,2A,5A 00.12~</p>  <p>W : 114.0 H : 56.5 T : 15.5</p>	<p><b>D1N019</b> ハジロミニ PAJERO MINI ハジロJr PAJERO Jr H51A,56A 94.11~ front H57A 95.10~</p>  <p>W : 110.2 H : 46.0 T : 14.5</p>
<p><b>D1N011</b> ミラージュ MIRAGE ランサー LANCER C51A,52A,61A 89.09~ front C61A,62A,64A 89.09~</p>  <p>W : 114.0 H : 49.8 T : 15.0</p>	<p><b>D1N021</b> ハジロミニ PAJERO MINI ハジロイオ PAJERO io H51A,53A,58A 97.06~ front H61W,66W,76W 98.03~</p>  <p>W : 123.0 H : 47.9 T : 15.5</p>
<p><b>D1N013</b> ミラージュ,ランサー MIRAGE,LANCER リベロ,カーゴ LIBERO,CARGO CA1A,2A,CC3A 91.08~ front CB2W,4W,5W,1V 92.04~</p>  <p>W : 114.0 H : 49.8 T : 15.0</p>	

**D1N033** パジロ PAJERO ストラダ STRADA  
 front V14V,24V,34V K34T  
 90.10~ 91.03~

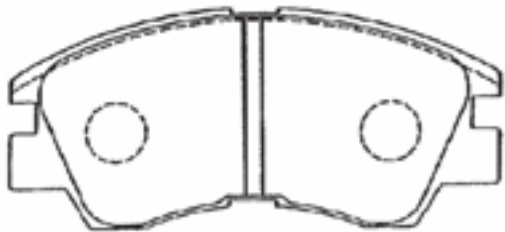
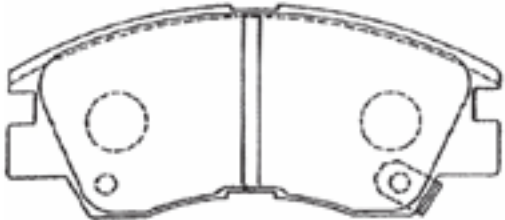
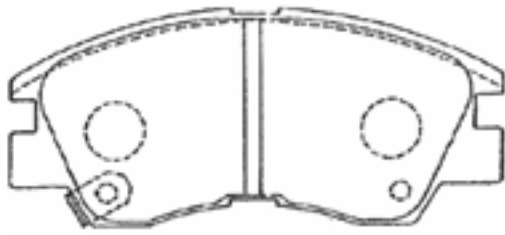

W : 127.9 H : 57.0 T : 17.0

**D1N035** シャリオ CHARIOT レグナム LEGNUM  
 front N33W,38W,48W EA1W,4W,5W,7W  
 91.05~ 96.08~

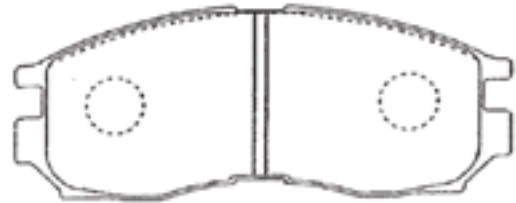
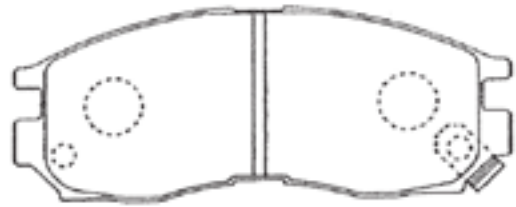
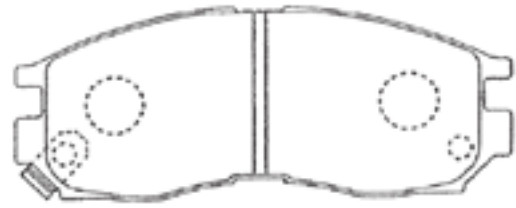

W : 127.8 H : 52.0 T : 16.0

**D1N034** デリカ DELICA ミラージュ MIRAGE  
 front PD4W,8W,PE8W CJ4A  
 94.03~ 95.08~

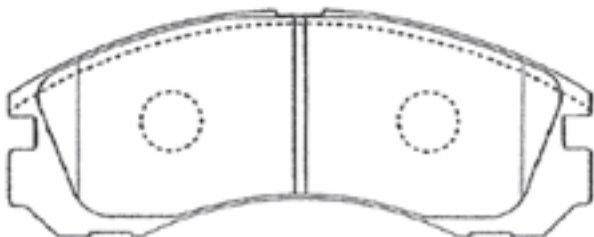
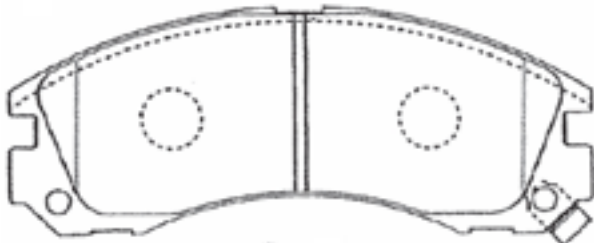
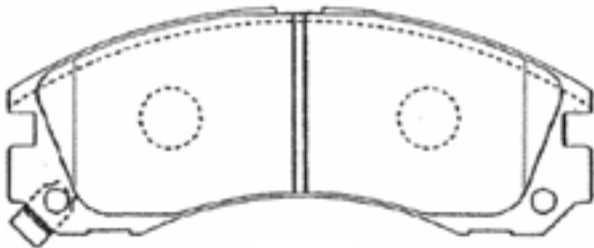

W : 149.8 H : 58.6 T : 15.6



**D1N038** キャンター  
CANTER  
front  
FB308,511,FE300 91.04~  
FA510 97.06~

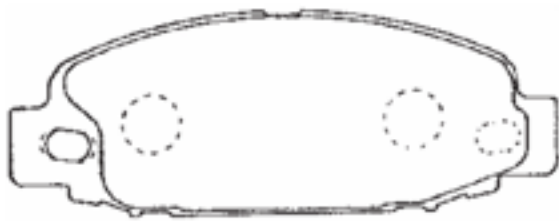

W : 140.2 H : 51.5 T : 18.0

**D1N039** キャンター  
CANTER  
front  
FB300,308 85.09~  
FE300,320,301 85.09~



W : 140.2 H : 51.5 T : 18.0

**D1N042** デリカ  
DELICA  
スヘースキー  
SPACEGEAR  
front  
P02T,13T,15T,25T 94.03~  
PA4W,5W,PB5W 94.03~

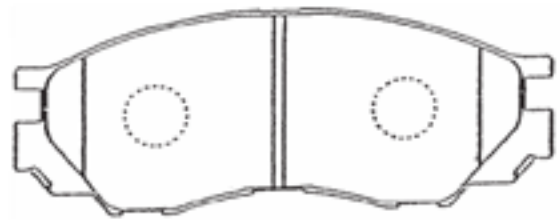

W : 137.7 H : 55.0 T : 15.6

**D1N045** シャリオグランデ  
CHARIOT  
front  
RVR  
N84W,94W,86W 97.08~  
N61W,71W,73WG 97.09~

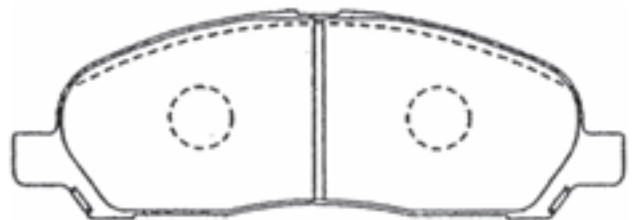

W : 156.9 H : 53.5 T : 16.0

**D1N046** ミニカトッポ  
MINICA, TOPPO  
EKワゴン  
eK WAGON  
front  
H41A,46A,47A 98.08~  
H81W 01.10~

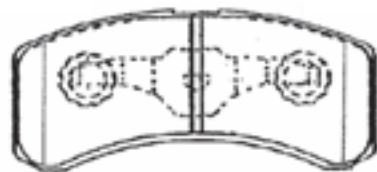
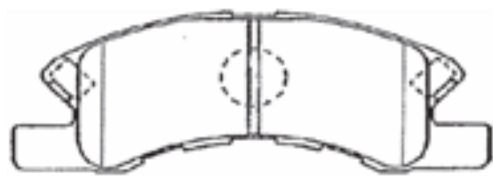

イナ W : 122.0 H : 44.3 T : 15.0

アウ W : 92.0 H : 44.3 T : 15.0

**D1N048** シャリオグランデイス  
CHARIOT  
デION  
DION

NA4W,84W,94W  
CR5W

00.04~  
02.05~

front

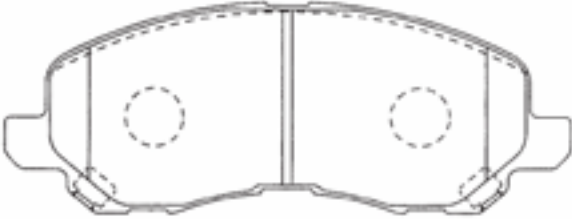

W : 145.0 H : 54.5 T : 15.8

**D2N022** チャレンジャー  
CHALLENGER

K94W,96W,99W  
K97WG,99WG

96.05~  
96.05~

rear

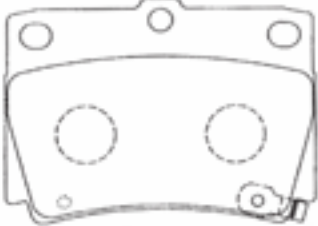

1枚

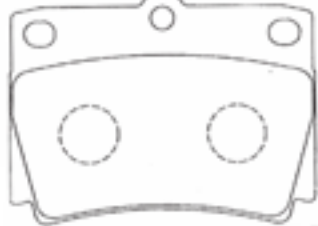

3枚

W : 78.8 H : 60.9 T : 15.0

**D2N012** GTO

Z15A,16A

92.10~

rear

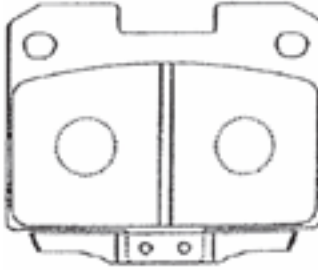
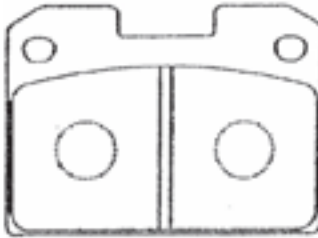
W : 81.3 H : 60.0 T : 16.0

**D2N028** ミラージュ,ランサー  
MIRAGE,LANCER  
エクリアス  
ECLIPSE

C53A,63A  
D27A

87.09~  
90.09~

rear

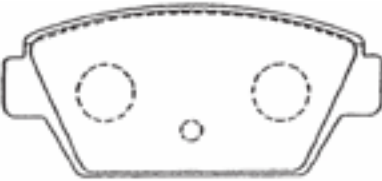



W : 98.3 H : 44.2 T : 14.0

**D2N032** デイマンテ  
DIAMANTE  
ギャラン  
GALANT

F11A,12A,13A  
E54A,64A,74A

90.02~  
92.02~

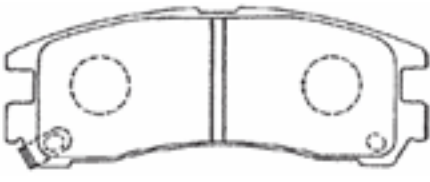
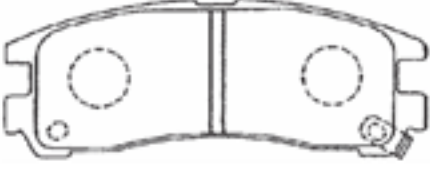
rear

W : 107.8 H : 41.0 T : 15.5

**D2N036** グランディス  
GRANDIS  
ブラクティイ  
PROUDIA  
rear N86W,96W  
S32A,33A,43A 99.08~  
00.02~

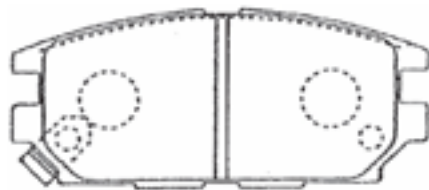

W : 107.9 H : 46.0 T : 15.4

**D2N037** ハジロ  
PAJERO  
スペースギア  
SPACEGEAR  
rear V24V,24C,24W  
PD4W,8W,PE8W 90.10~  
90.10~

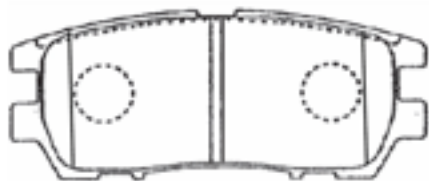
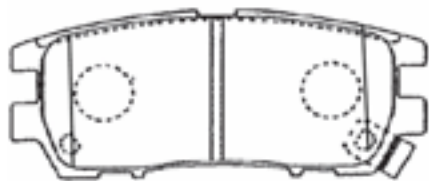
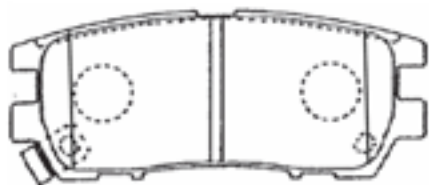

W : 107.9 H : 43.4 T : 14.0

**D2N040** ミラージュ,ランサー  
MIRAGE,LANCER  
コルト  
COLT  
rear CA1A,2A,CB1A  
Z27A,23A,27W 91.08~  
04.08~

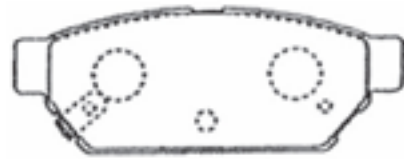

W : 98.8 H : 37.5 T : 14.5

**D2N041** エクリプス,スパイダー  
ECLIPSE,SPIDER  
ミラージュ,ランサー  
MIRAGE,LANCER  
rear D22A,27A  
C53A,63A 89.09~  
90.10~



W : 98.7 H : 44.3 T : 14.5

**D2N049** ランサーワゴン  
LANCER WAGON  
エアトリック  
AIRTREK  
rear CS5W  
CU2W,4W,5W 01.05~  
02.05~

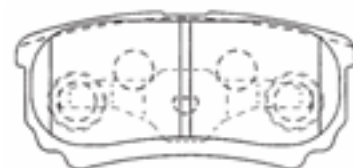
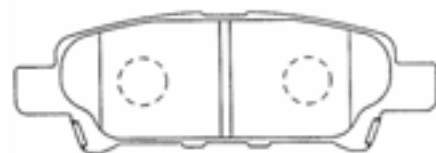

インナ W : 105.9 H : 35.7 T : 15.5

アウト W : 86.0 H : 40.0 T : 15.5

**E1N003** ファミリア FAMILIA  
front ファミリアワゴン FAMILIA WAGON  
BJ3P,5P,BJEP 98.04~  
BJ5W,8W 98.04~



W : 123.0 H : 51.7 T : 15.5

**E1N004** MPV  
front  
LWEW,LW5W 99.05~  
LFWF,LW3W 02.04~

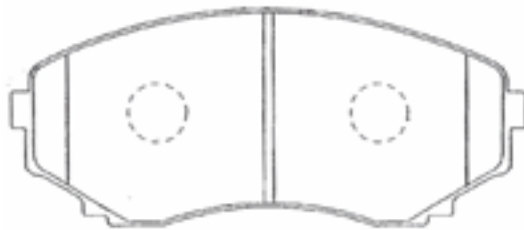

W : 139.2 H : 59.1 T : 16.0

**E1N006** RX-8 SE3P 03.04~  
front

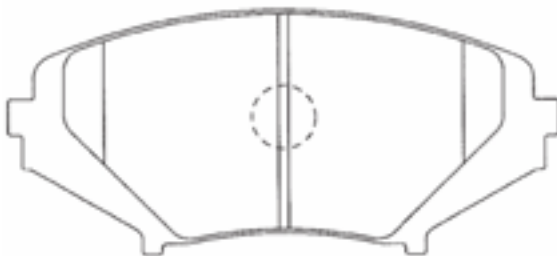

W : 138.0 H : 62.1 T : 16.5

**E1N008** ホンダ BONGO  
front J100  
SE88M,28M,48V 83.09~  
SS88MF,SSF8F 83.09~

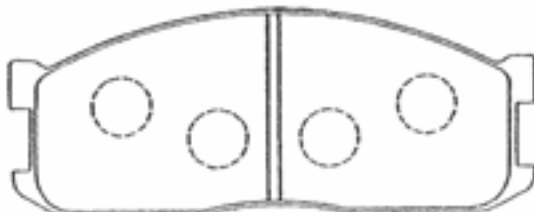

W : 133.0 H : 52.0 T : 15.5

**E1N009** ホンダ BONGO  
front BONGO BRAWNY  
SS88M,SS28M 87.09~  
SR89V,SRE9W 87.09~

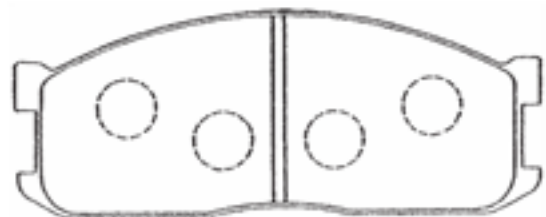
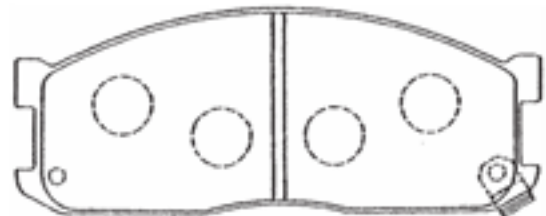
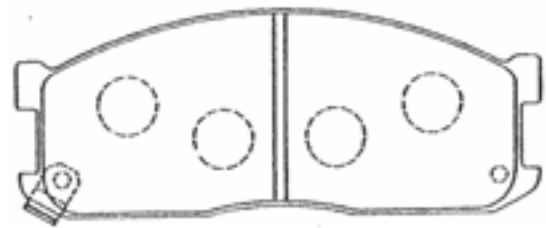

W : 133.0 H : 52.0 T : 15.5

**E1N011** RX-7 FC3S 85.09~  
front (C/#111985~)

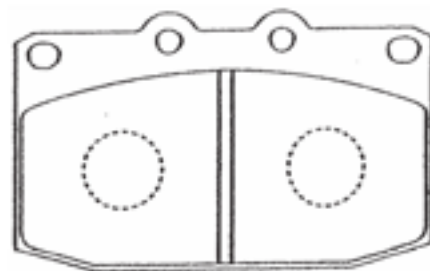

W : 107.1 H : 67.4 T : 14.7

**E1N014** ファミリア  
FAMILIA  
テミオ  
DEMO  
front  
BG3P,5P,6P  
DW3W,5W  
89.01~  
96.07~

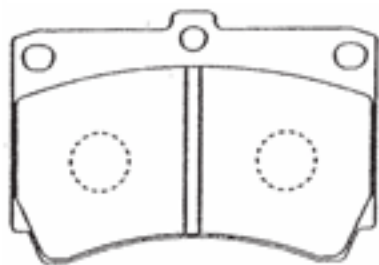
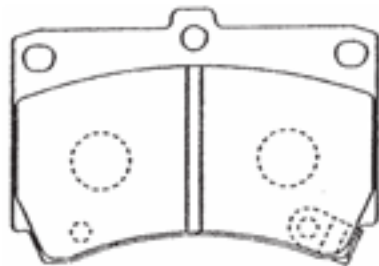
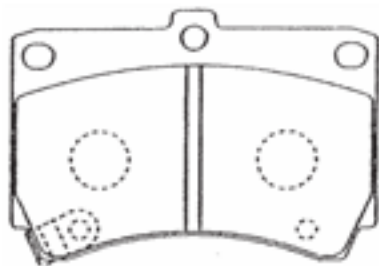

W : 91.8 H : 64.0 T : 15.0

**E1N015** ユーノロードスター  
EUNOSROADSTER  
front  
NA6CE  
89.07~



W : 110.1 H : 46.0 T : 14.5

**E1N016** ファミリア  
FAMILIA  
ランティス  
LANTIS  
front  
BG8P,BG8S  
CBA8P  
89.01~  
93.06~

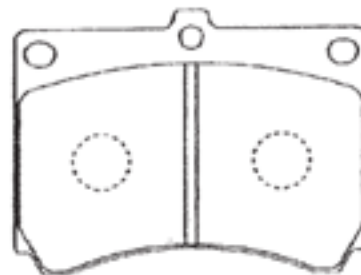
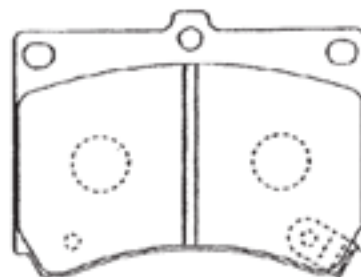
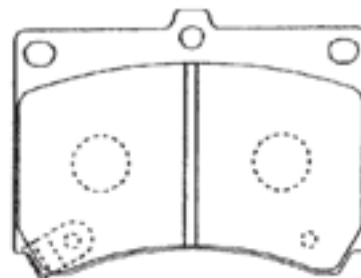

W : 91.8 H : 71.0 T : 15.0



**E1N018** MPV LVEW 89.11~  
front

W: 133.0 H: 56.0 T: 15.5

**E1N021** ホンゴフレんディ BONGO FRIENDEE  
front DELICA SKE6V,SK56M 95.05~  
99.06~

W: 139.2 H: 60.1 T: 16.0

**E1N022** ユノスロードスター EUNOSROADSTER NA8C,NB6C,8C 93.08~  
front

W: 110.1 H: 57.0 T: 13.0

**E1N026** ファミリアS-ワゴン FAMILIA S-WAGON  
front レーサーライド LASER RIDEA BJ5W,8W,BJFW 98.05~  
BJ5PF,8WF 98.11~

**E1N019** RX-7 FD3S 91.10~  
front

W: 107.1 H: 67.4 T: 14.8

インナ W: 131.5 H: 51.5 T: 15.5  
アウト W: 131.5 H: 51.5 T: 14.5

**E1N035** かへらコーゴ  
 CAPELLA WAGON  
 ユーノス300  
 EUNOS300  
 front  
 GD8Y,GV6V,FV  
 MA8P,8PE,EP  
 87.07~  
 88.10~

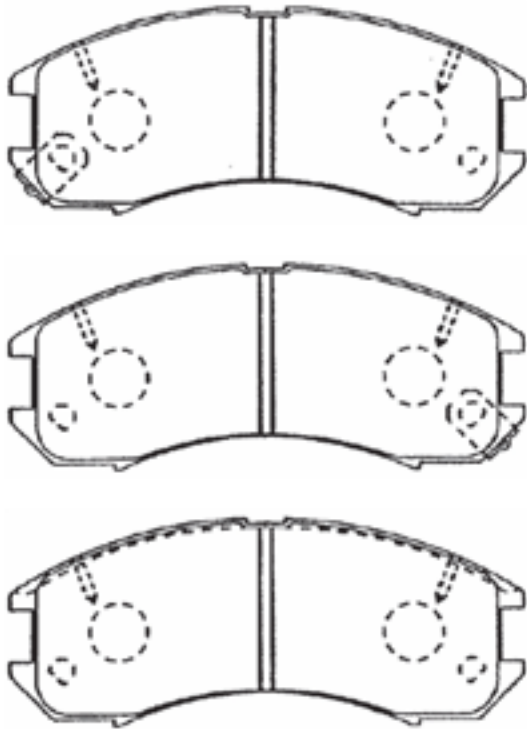

インナ W : 129.8 H : 52.5 T : 16.0  
 アウタ W : 129.8 H : 52.5 T : 15.0

**E1N038** ユーノス800  
 EUNOS 800  
 ミレニア  
 MILLENIA  
 front  
 TA3A,3P,3Y,3Z  
 TAFP  
 93.08~  
 98.06~

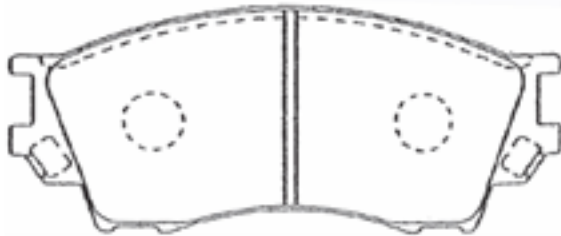

W : 142.0 H : 59.8 T : 15.0

**E1N042** かへらコーゴコン  
 CAPELLA WAGON  
 テルスター wagon  
 TELSTAR WAGON  
 front  
 GWER,GWFW  
 GWERF,GWFWF  
 97.10~  
 97.10~

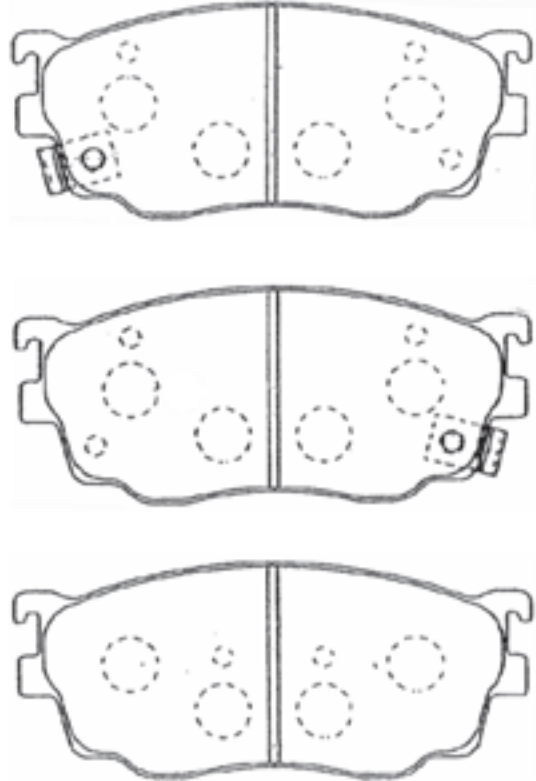

インナ W : 131.5 H : 56.1 T : 16.0  
 アウタ W : 131.5 H : 56.1 T : 15.0

**E1N053** MPV LY3P  
 front  
 06.02~

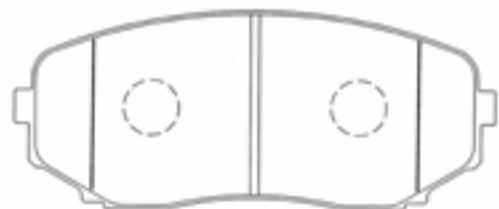



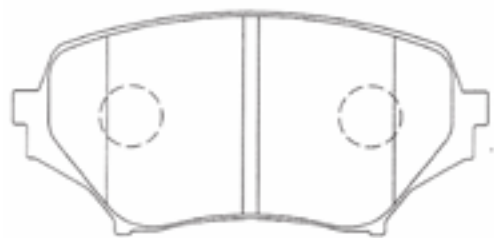

W : 139.0 H : 58.0 T : 17.5

**E1N054** ロードスター  
 ROADSTER  
 front  
 NCEC  
 05.08~

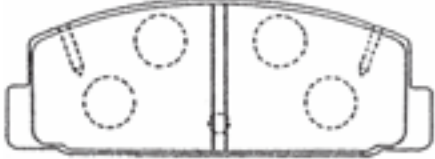

W : 123.0 H : 58.3 T : 14.5

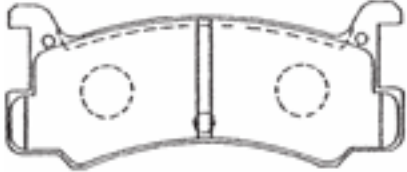
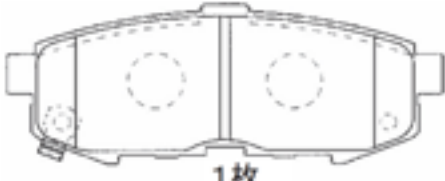
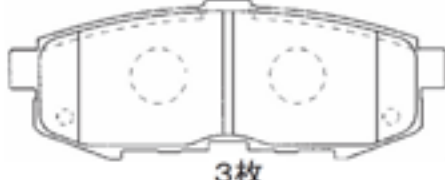
<p><b>E2N029</b>    ランティス LANTIS ファミリア FAMILIA</p> <p>rear</p> <p>CBA8P,EP    93.06~ BHALS,LP,5P,5S    94.03~</p>  <p>W : 102.0 H : 42.9 T : 12.6</p>	<p><b>E2N033</b>    ファミリア FAMILIA ファミリアS-ワゴン FAMILIA S-WAGON</p> <p>rear</p> <p>BG8Z,BJ5P    90.11~ BJ5W,8W,FW    98.05~</p>  <p>W : 107.8 H : 39.5 T : 13.0</p>
<p><b>E2N030</b>    ユーノロードスター EUNOSROADSTER</p> <p>rear</p> <p>NA8C,NB6C,8C    97.12~</p>    <p>W : 102.0 H : 42.9 T : 12.6</p>	<p><b>E2N043</b>    ファミリアS-ワゴン FAMILIA S-WAGON</p> <p>rear</p> <p>BJFW (2WD)    99.06~</p>  <p>W : 100.7 H : 39.0 T : 13.0</p>
<p><b>E2N032</b>    シャレード CHARADE ミラ MIRA</p> <p>rear</p> <p>G200S,201,203    93.01~ L502S    94.08~</p>  <p>W : 101.6 H : 41.7 T : 12.0</p>	<p><b>E2N048</b>    MPV</p> <p>rear</p> <p>LW3W,LWFW    02.04~</p>  <p>1枚</p>  <p>3枚</p> <p>W : 110.5 H : 41.0 T : 16.0</p>

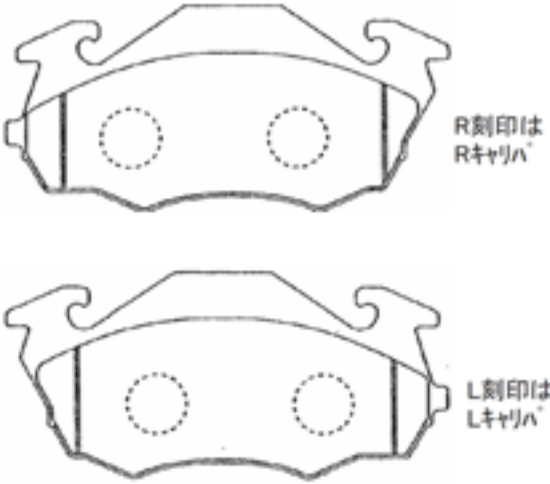
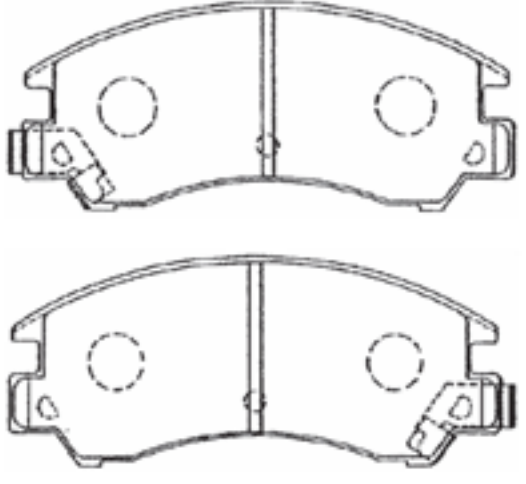
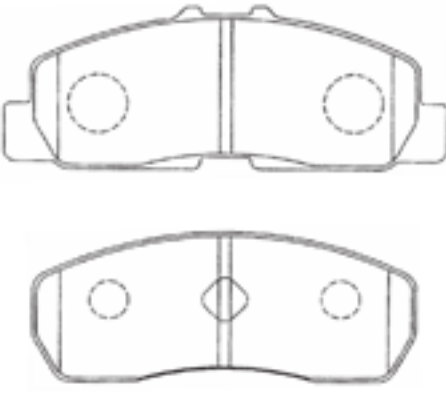
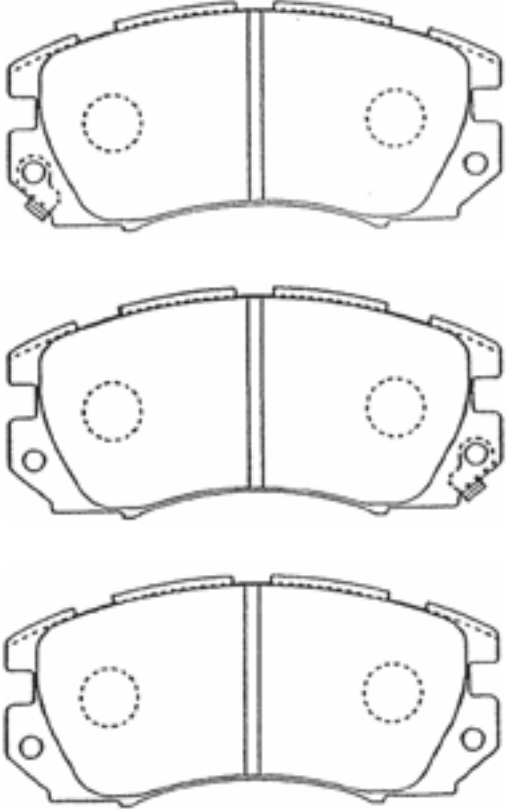

<p><b>F1N003</b> サンバー SAMBAR ドミンゴ DOMINGO</p> <p>KV3,4,KS3,4 FA7,8</p> <p>90.03~ 94.06~</p> <p>front</p>  <p>R刻印は Rキャリハ</p> <p>L刻印は Lキャリハ</p> <p>W : 118.0 H : 53.6 T : 15.0</p>	<p><b>F1N008</b> レオーネバン LEONE VAN レオーネ LEONE</p> <p>AP2,3,9 AA2,3</p> <p>84.06~ 84.07~</p> <p>front</p>  <p>W : 127.2 H : 54.8 T : 17.0</p>
<p><b>F1N005</b> フレオ PLEO</p> <p>RA1,2,RV1,2</p> <p>98.10~</p> <p>front</p>  <p>インナ W : 112.4 H : 42.0 T : 14.0 アウト W : 99.1 H : 40.0 T : 14.0</p>	<p><b>F1N011</b> レガシィ LEGACY インプレッサ IMPREZA</p> <p>BC4,5,BF5,7,BD5 GC8,GF8</p> <p>89.02~ 92.11~</p> <p>front</p>  <p>W : 127.8 H : 59.0 T : 17.0</p>

**F1N013** レガシィ LEGACY フォレスター FORESTER  
 front BD5,9,BE5,BG5 SF5,9  
 96.06~ 97.02~

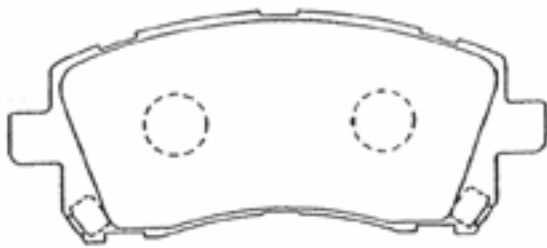

W : 137.8 H : 59.5 T : 17.0

**F1N014** レガシィ LEGACY インプレッサ IMPREZA  
 front BD2,3,4,5,BG2,3 GC1,2,8,GF1,2,5  
 96.06~ 96.09~



W : 137.8 H : 53.9 T : 17.0

**F1N018** インプレッサ IMPREZA レガシィ LEGACY  
 front GD9 BL5,BP5  
 02.11~ 03.05~

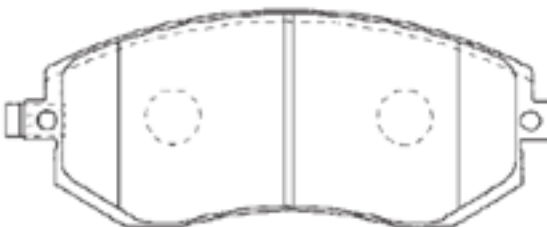

1枚

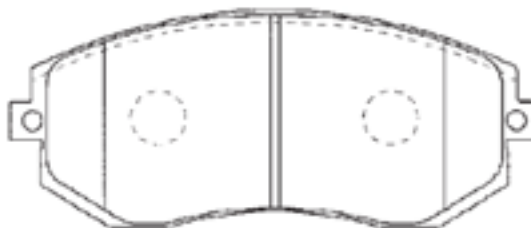

3枚

W : 137.0 H : 56.8 T : 17.0

**F1N019** レガシィ LEGACY  
 front BLE,BL5,BPE  
 03.05~

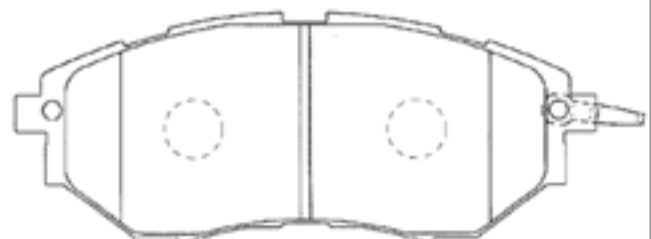
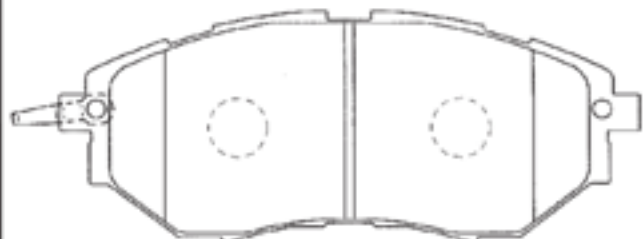
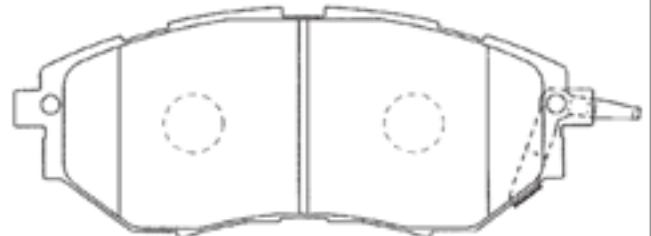
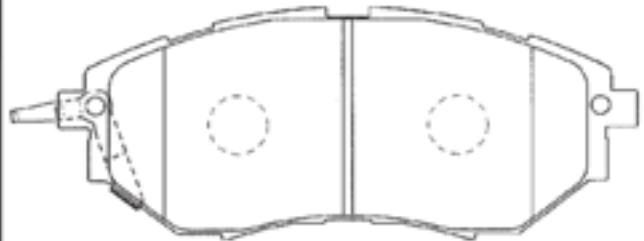

W : 157.0 H : 63.4 T : 17.0

<b>F2N012</b>	レガシィ	BC3,4,5,BD4,5	89.02~
	LEGACY		
rear	インプレッサ	GC1,2,4,6,8,GF3	92.11~
	IMPREZA		

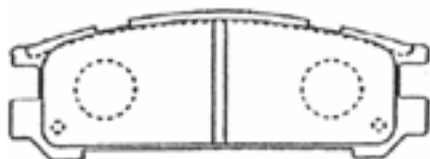
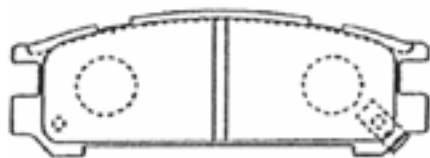
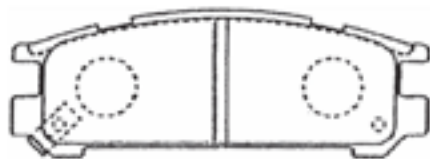

W : 107.8 H : 38.6 T : 15.0

<b>F2N015</b>	フォレスター	SF5,9	97.02~
	FORESTER		
rear	インプレッサ	GC8,GF8,GDA	98.09~
	IMPREZA		

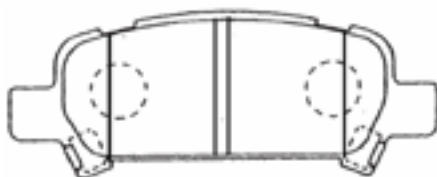

W : 108.4 H : 42.0 T : 14.0

<b>F2N016</b>	インプレッサ	GD9	02.11~
	IMPREZA		
rear	フォレスター	SG5	03.02~
	FORESTER		

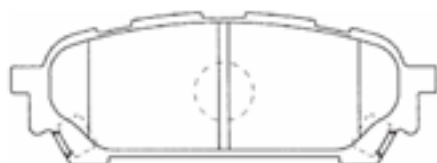

W : 108.5 H : 39.5 T : 14.0

**G1N006** エブリプラス  
front EVERY PLUS  
スィフト SWIFT  
DA32W HT51S,81S  
99.06~  
00.02~

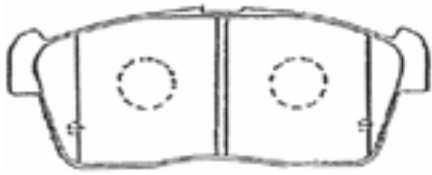

W : 108.5 H : 45.4 T : 15.0

**G1N011** ハイゼット  
front HIJET  
スパーキー SPARKY  
S100V,100W,200V S221,231  
94.01~  
00.09~

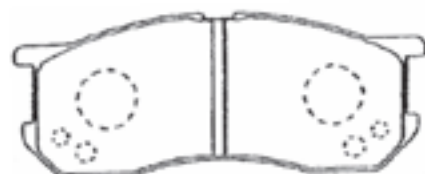
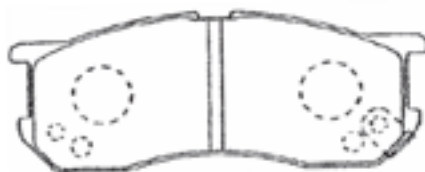
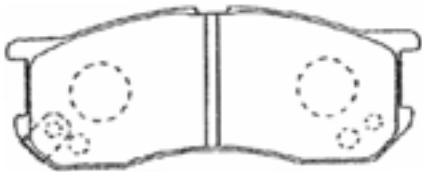

W : 106.1 H : 41.5 T : 15.0

**G1N015** ミラ  
front MIRA  
ムーブ MOVE  
L200S,210S,500S L600S,602S,610S  
91.05~  
96.04~

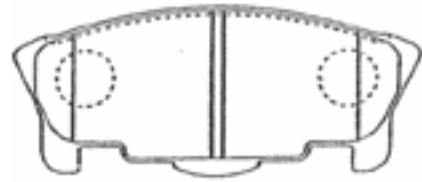

W : 104.6 H : 45.0 T : 13.5

**G1N017** ハイザー  
front PYZAR  
G303G,313G G301G,311G  
96.08~  
97.09~

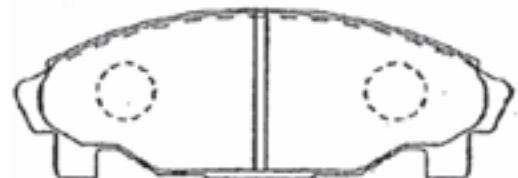
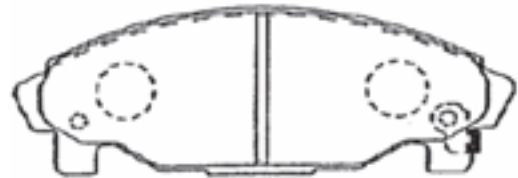
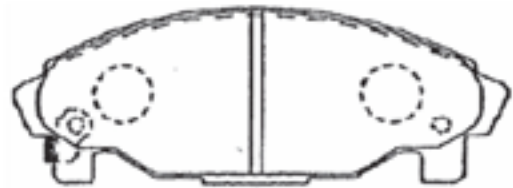

W : 127.6 H : 45.3 T : 15.0

**G1N018** フロント  
DUET  
front YRV M100A,110A,101A 98.09~  
M200G,201G,211G 00.08~

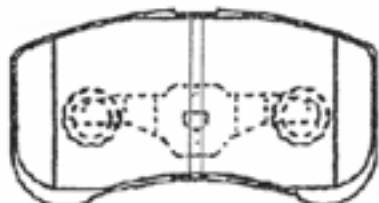
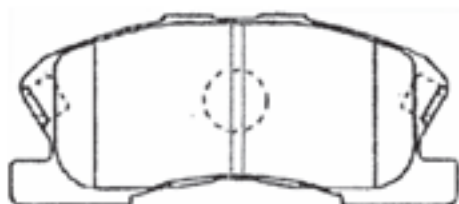

インナ W: 115.4 H: 49.7 T: 15.5  
アウト W: 95.0 H: 49.6 T: 15.5

**G1N019** フロント  
OPTI  
ムーブ MOVE L300S 96.04~  
L600S,610S 96.04~

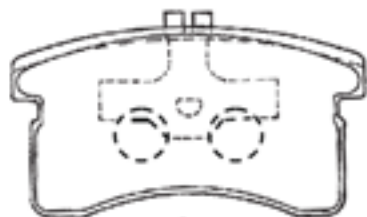





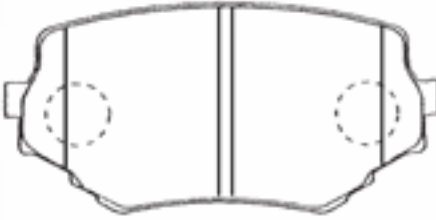
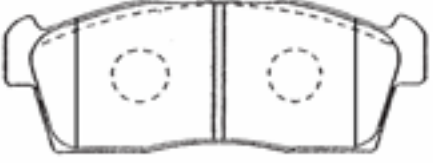

W: 88.4 H: 49.0 T: 13.5

**G2N010** AZ-3.7レック  
AZ-3.PRESSO EC5SA,8SE 91.06~  
rear ユーノス100 EUNOS100 EG8PE 98.10~

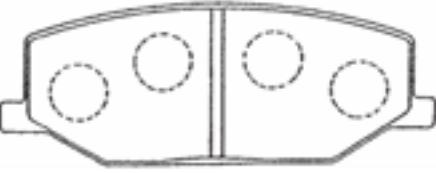
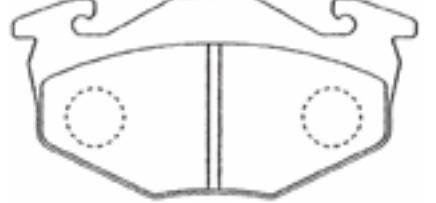

W: 102.0 H: 39.0 T: 12.5

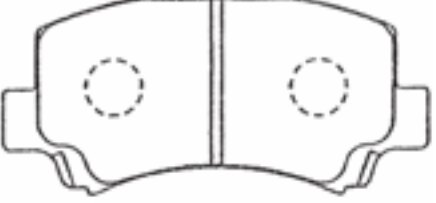
<b>H1N001</b> front	エスクード ESCUDO アロハード,レバンテ PROCEED, LEVANTE	TA11W,31W TF11W,31W	94.12~ 95.01~	<b>H1N009</b> front	ワゴン WAGON R Kei	MC11S,21S HN11S,22S	98.10~ 98.10~			
								<b>W : 108.5 H : 41.9 T : 15.0</b>		
<b>W : 110.2 H : 51.8 T : 15.0</b>				<b>H1N011</b> front	ジムニーシエラ JIMNY SIJERA ジムニーワイド JIMNY WIDE	JB31W,32W JB33W,43W	93.05~ 98.01~			
								<b>W : 110.4 H : 41.5 T : 15.0</b>		
<b>H1N005</b> front	AZ-1,AZワゴン AZ-1,AZ WAGON ワゴン WAGON R	PG6SA,CY21S CT21S,CV21S	92.08~ 93.09~	<b>H1N014</b> front				キャロル,AZワゴン CAROL,AZ WAGON ワゴン WAGON R	AA6PA,CY21S CT21S,CV21S	92.07~ 93.09~
<b>W : 108.6 H : 39.1 T : 13.8</b>								<b>W : 105.0 H : 54.0 T : 15.0</b>		
<b>H1N006</b> front	スクラム SCRUM キャリイ,エブリー CARRY,EVERY	DG41V,DK51B DA41,DE51V	89.05~ 89.05~	<b>H1N016</b> front				カルタスクレセント CULTUS CRESENT	GA11S,GB31S GC21W,GD31W	95.01~ 96.02~
								<b>W : 111.4 H : 48.5 T : 15.0</b>		
				<b>H1N020</b> front				ワゴンワイド WAGON R WIDE ワゴンR(+プラス) WAGON R PLUS	MA61S,MB61S MA63S	97.02~ 99.05~
<b>インナ W : 102.0 H : 40.0 T : 15.0</b> <b>アウト W : 88.0 H : 40.0 T : 15.0</b>								<b>W : 106.4 H : 50.0 T : 15.0</b>		
<b>H1N008</b> front	ワゴン WAGON R アルト ALTO	CT21S,CV21S HA11S,HB11S	95.10~ 94.11~							



**J1N008** ビッグホーン  
BIGHORN  
ビーグロス  
VEHI CROSS  
front

UBS25,26,69,73 91.12~  
UGS25 97.05~

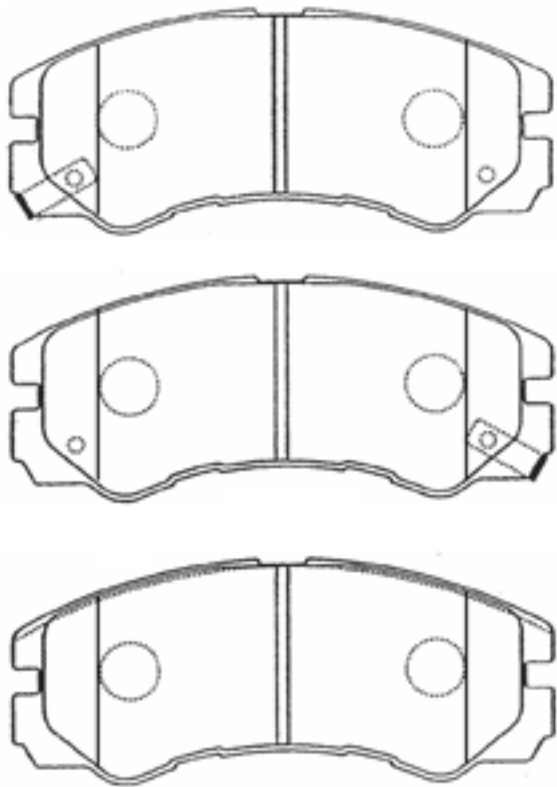

W : 137.8 H : 58.7 T : 16.5

**J2N009** ビッグホーン  
BIGHORN  
ビーグロス  
VEHI CROSS  
rear

UBS25,26,69,73 91.12~  
UGS25 97.05~

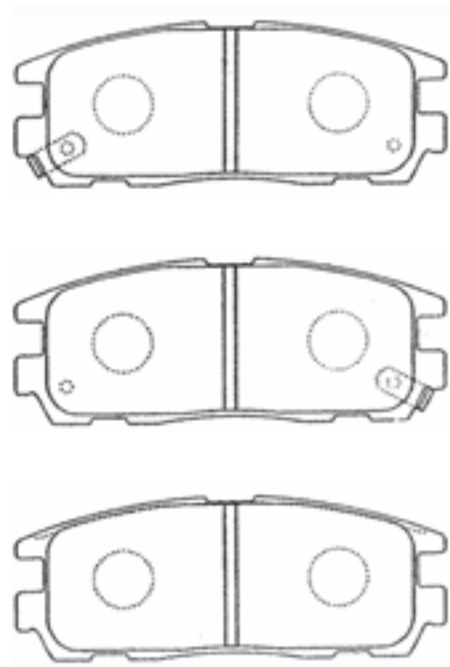

W : 109.6 H : 42.5 T : 16.0

**J1N010** ビッグホーン  
BIGHORN  
ミュウ  
MU  
front

UBS17,55 87.06~  
UCS17,55 89.02~

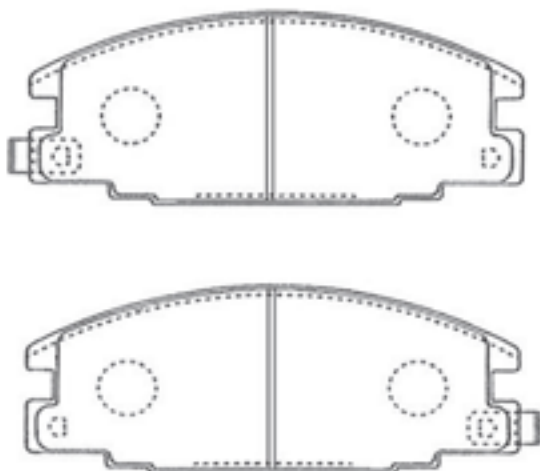

W : 127.0 H : 51.0 T : 16.0

**J2N016** ミューウィザード  
MU.WIZARD  
rear

UES73,UER25 98.03~

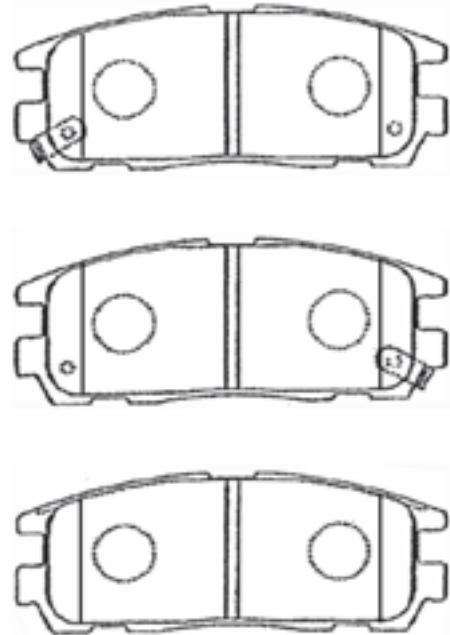

W : 109.6 H : 42.5 T : 14.0





# BRAKE SYSTEM PICTURES





**47710-6010**



**47720-6010**



**47750-30233**



**47750-33020**



**47750-33100**



**47750-50031**



**AD-002R**



**AD-004**



**AD-005L**



**AD-005R**



**AD-006L**



**AD-009R**



**AD-010L**



**AD-010R**



**AD-020LFA**



**AD-020LFB**



**AD-020RFA**



**AD-020RFB**



**AD-022LA**



**AD-022LB**



**AD-022RA**



**AD-022RB**



**AD-027**



**AF-002**



**AG-002LR**



**AG-003RF**



**AH-001L**



**AH-002L**



**AH-002R**



**AH-003L**



**AH-004**



**AH-008**



**AH-011LFA**



**AK-002**



**AK-003**



**AK-004**



**AM-001L**



**AM-001R**



**AM-002R**



**AM-003L**



**AM-003R**



**AM-004**



**AM-010L**



**AM-010R**



**AM-011R**



**AM-012**



**AM-018**



**AN-002**



**AN-003**



**AN-004**



**AN-005**



**AN-006**



**AN-008**



**AN-009**



**AN-010**



**AN-012**



**AN-013**



**AN-016**



**AN-028**



**AN-029**







**AN-904**



**AN-905**



**AO-001**



**AS-001L**



**AS-001R**



**AS-002R**



**AS-003L**



**AS-005L**



**AS-005R**



**AS-006L**



**AS-006R**



**AS-007L**



**AS-007R**



**AS-008**



**AS-009L**



**AS-011**



**AS-013**



**AS-016L**



**AS-016R**



**AS-017FU**



**AS-020L**



**AS-020R**



**AS-023**



**AS-026**



**AS-027L**



**AT-042R**



**AT-047L**



**AT-047R**



**AY-001**



**AY-003L**



**AY-003R**



**AY-010R**



**AY-012L**



**AY-014L**



**AY-016L**



**AY-017R**



**AZ-002**



**AZ-003**



**AZ-005**



**AZ-006L**



**AZ-006R**



**AZ-007L**



**AZ-007R**



**AZ-019L**



**AZ-022L**



**AZ-022R**



**AZ-023L**



**AZ-023R**



**AZ-030L**



**AZ-030R**



**BBD-006**



**BBT-003**



**BBT-010**



**BBT-022**



**BBT-026**



**BBT-031**



**BBT-038**



**BBT-041**



**BBT-052**



**BBT-053**



**BBT-074**



**BBT-094**



**BMD-002**



**BMS-001**



**BMS-004**



**BMS-008**



**BMS-010**



**BMT-004**



**BMT-005**



**BMT-007**



**BMT-008**



**BMT-009**



**BMT-010**



**BMT-013**



**BMT-015**





**BMT-016**



**BMT-022**



**BMT-024**



**BMT-025**



**BMT-027**



**BMT-028**



**BMT-029**



**BMT-033**



**BMT-034**



**BMT-035**



**BMT-040**



**BMT-041**



**BMT-043**



**BMT-048**



**BMT-052**



**BMT-059**



**BMT-062**



**BMT-063**



**BMT-064**

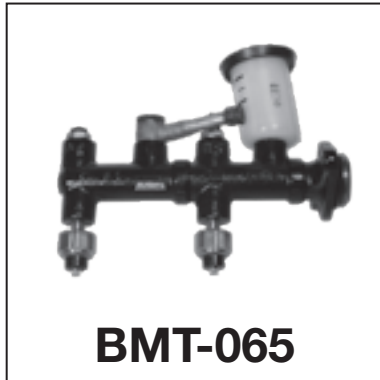

**BMT-065**



**BMT-067**



**BMT-068**



**BMT-069**



**BMT-070**



**BMT-075**



**BMT-076**

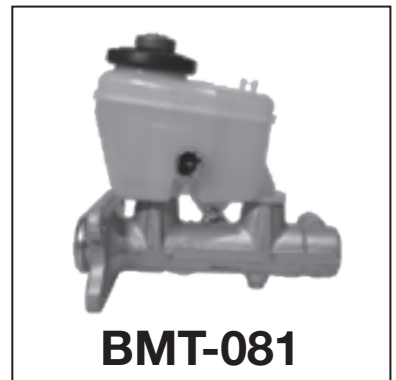

**BMT-081**



**BMT-084**



**BMT-085**



**BMT-088**



**BMT-089**

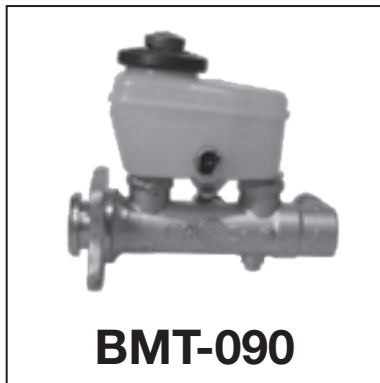

**BMT-090**



**BMT-091**

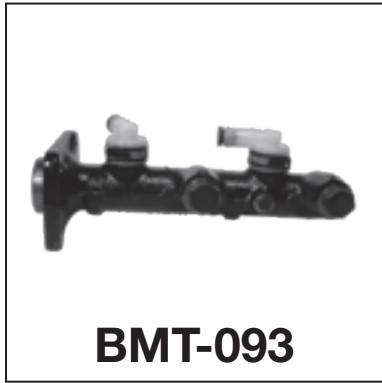

**BMT-093**



**BMT-096**



**BMT-099**

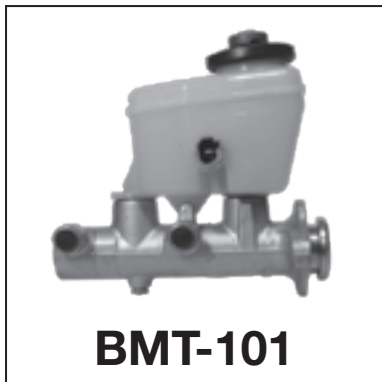

**BMT-101**

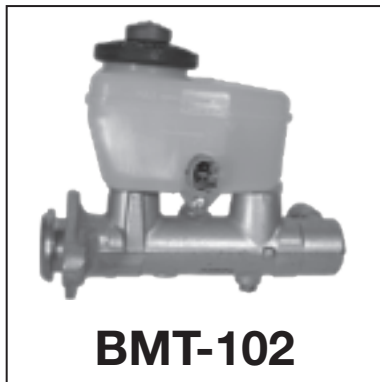

**BMT-102**



**BMT-103**



**BMT-107**



**BMT-110**



**BMT-112**



**BMT-113**



**BMT-117**



**BMT-125**





**BMT-127**



**BMT-130**



**BMT-131**



**BMT-133**



**BMT-136**



**BMT-141**



**BMT-145**



**BMT-148**



**BMT-149**



**BMT-150**



**BMT-151**



**BMT-152**



**BMT-153**



**BMT-154**



**BMT-155**

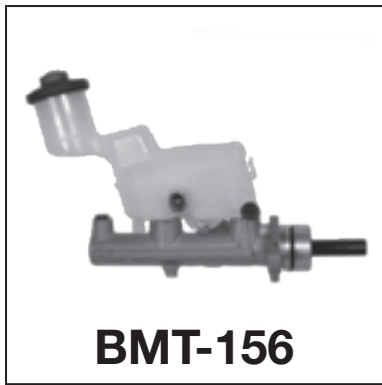

**BMT-156**

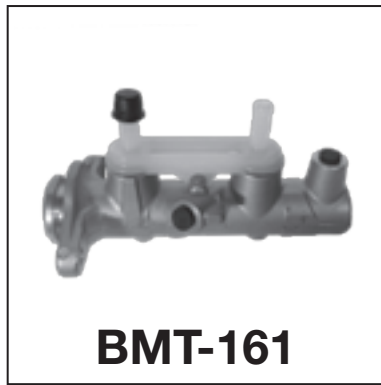

**BMT-161**

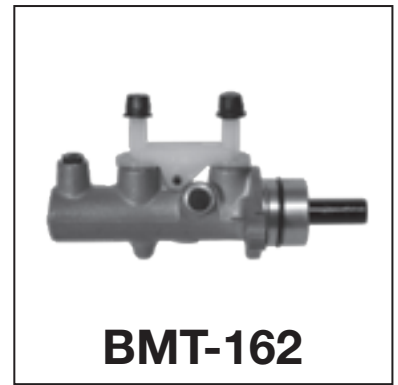

**BMT-162**

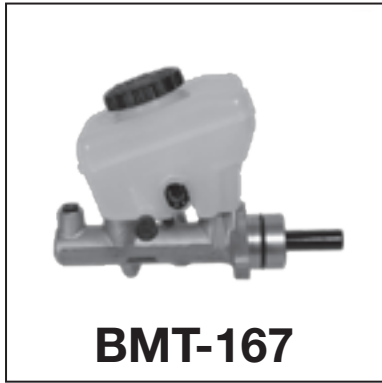

**BMT-167**



**BMT-170**



**BMT-171**



**BMT-198**



**BMT-202**



**BMT-209**

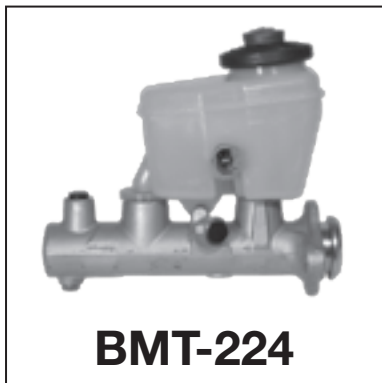

**BMT-224**



**BMT-232**



**BMT-234**

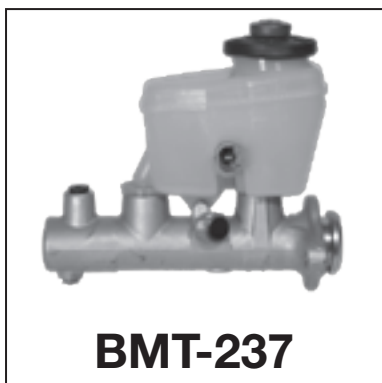

**BMT-237**



**BMT-238**



**BMT-239**



**BMT-244**



**BMT-252**



**BMT-258**



**BMT-262**



**BMT-267**



**BMT-275**

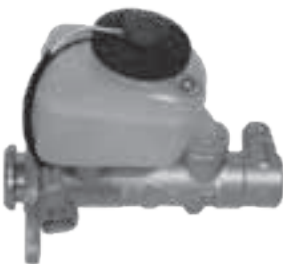

**BMT-304**



**BMW-002**



**BMW-003**



**BMW-004**



**BMW-006**



**BMW-008**



**BMW-009**



**EG-007LR**

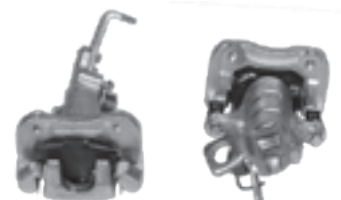

**EH-004L**



**EH-004R**



**EM-036L**



**EM-037LR**



**ES-004L**



**ES-004R**



**ET-033L**



**ET-033R**



**ET-034L**



**ET-034R**

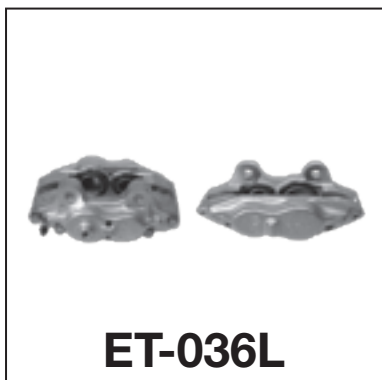

**ET-036L**



**ET-037R**



**ET-038L**



**EZ-034LR**



**EZ-034RR**



**MD-003**



**MD-018**



**MD-024**



**MD-030**



**MF-004**



**MF-009**



**MF-011**



**MG-001**



**MG-003**



**MG-004**



**MG-005**



**MG-011**



**MG-016**



**MG-018**



**MG-019**



**MH-001**



**MH-002**



**MH-003**



**MH-008**



**MH-010**



**MH-012**

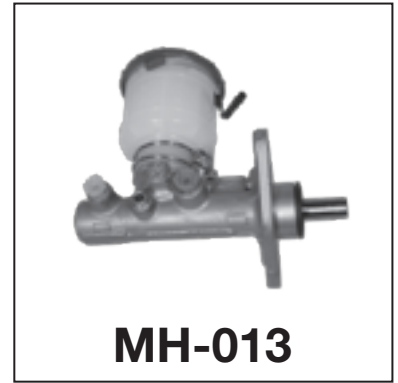

**MH-013**



**MH-017**



**MH-018**



**MH-020**



**MM-004**



**MM-009**



**MM-011**



**MM-014**



**MM-019**



**MM-031**





**MM-034**



**MM-038**



**MM-044**



**MM-045**



**MM-046**



**MM-051**



**MM-054**



**MM-058**



**MM-063**



**MM-065**



**MN-003**



**MN-005**



**MN-007**



**MN-012**



**MN-014**





**MN-019**



**MN-021**



**MN-022**



**MN-023**



**MN-027**



**MN-069**



**MN-074**



**MN-078**



**MN-081**



**MN-089**



**MN-090**



**MN-100**



**MN-105**



**MN-109**



**MN-118**



**MN-119**



**MN-120**



**MN-124**



**MN-125**



**MN-128**



**MN-901**



**MN-902**



**MN-903**



**MO-006**



**MO-016**



**MO-018**



**MS-001**



**MS-005**



**MS-006**



**MS-011**



**MS-016**



**MT-008**



**MY-005**



**MY-007**



**MY-011**

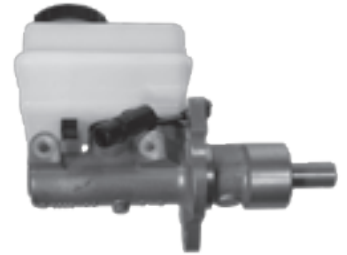

**MY-012**



**MY-013**



**MY-016**



**MY-017**



**MY-018**



**MY-019**



**MY-023**



**MY-030**



**MY-032**



**MZ-001**



**MZ-003**

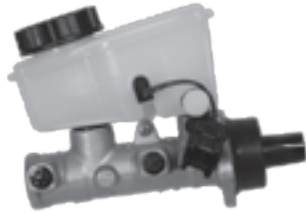

**MZ-019**



**MZ-020**



**MZ-039**



**MZ-042**



**MZ-048**



**MZ-088**



**WCD-001**



**WCD-003**



**WCT-001**



**WCT-002**



**WCT-003**



**WCT-004**



**WCT-005**



**WCT-006**



**WCT-007**



**WCT-011**



**WCT-013**



**WCT-014**



**WCT-015**



**WCT-016**



**WCT-017**



**WCT-018**



**WCT-019**



**WCT-020**



**WCT-021**



**WCT-022**



**WCT-023**



**WCT-024**



**WCT-027**





**WCT-028**



**WCT-033**



**WCT-034**



**WCT-035**



**WCT-036**



**WCT-038**



**WCT-039**



**WCT-040**



**WCT-041**



**WCT-042**



**WCT-044**



**WCT-046**



**WCT-047**



**WCT-048**



**WCT-049**



**WCT-051**



**WCT-053**



**WCT-054**



**WCT-055**



**WCT-056**



**WCT-057**



**WCT-059**



**WCT-060**



**WCT-061**



**WCT-062**



**WCT-063**



**WCT-064**



**WCT-068**



**WCT-069**



**WCT-070**





**WCT-072**



**WCT-075**



**WCT-078**



**WCT-079**



**WCT-081**



**WCT-084**



**WCT-090**



**WCT-108**



**WCT-115**



**WCT-118**



**WCT-119**



**WCT-121**



**WCT-122**



**WCT-133**



**WCT-134**



**WCT-135**



**WCT-136**



**WCT-137**



**WCT-138**



**WCT-145**



**WCT-146**



**WCT-147**



**WCT-151**



**WCT-152**



**WCT-178**



**WCT-192**



**WCT-199**



**WCT-206**



**WCT-209**



# CROSS REFERENCE LIST



OE N <sup>R</sup> TO AISIN N <sup>R</sup>	185	
ABS N <sup>R</sup> TO AISIN N <sup>R</sup>	213	
AKEBONO N <sup>R</sup> TO AISIN N <sup>R</sup>	215	
ASHIKA N <sup>R</sup> TO AISIN N <sup>R</sup>	216	
ATE N <sup>R</sup> TO AISIN N <sup>R</sup>	218	233 JURID N <sup>R</sup> TO AISIN N <sup>R</sup>
BENDIX N <sup>R</sup> TO AISIN N <sup>R</sup>	219	234 KASHIYAMA N <sup>R</sup> TO AISIN N <sup>R</sup>
BOSCH N <sup>R</sup> TO AISIN N <sup>R</sup>	221	235 MINTEX N <sup>R</sup> TO AISIN N <sup>R</sup>
CIFAM N <sup>R</sup> TO AISIN N <sup>R</sup>	222	236 NISSHINBO N <sup>R</sup> TO AISIN N <sup>R</sup>
FERODO N <sup>R</sup> TO AISIN N <sup>R</sup>	224	237 PAGID N <sup>R</sup> TO AISIN N <sup>R</sup>
FTE N <sup>R</sup> TO AISIN N <sup>R</sup>	226	238 REMSA N <sup>R</sup> TO AISIN N <sup>R</sup>
HP N <sup>R</sup> TO AISIN N <sup>R</sup>	227	239 ROADHOUSE N <sup>R</sup> TO AISIN N <sup>R</sup>
ICER BRAKES N <sup>R</sup> TO AISIN N <sup>R</sup>	230	240 SUMITOMO N <sup>R</sup> TO AISIN N <sup>R</sup>
JAPANPARTS N <sup>R</sup> TO AISIN N <sup>R</sup>	231	241 TEXTAR N <sup>R</sup> TO AISIN N <sup>R</sup>
		242 TOKICO N <sup>R</sup> TO AISIN N <sup>R</sup>
		243 TRW N <sup>R</sup> TO AISIN N <sup>R</sup>





# CROSS REFERENCE LIST

## OE N<sup>R</sup> TO AISIN N<sup>R</sup>

OE N <sup>R</sup>	AISIN N <sup>R</sup>	OE N <sup>R</sup>	AISIN N <sup>R</sup>	OE N <sup>R</sup>	AISIN N <sup>R</sup>
00000A00529	AT-050	04465-26050	A1N049	04465-YZZAJ	A1N036
00000A00721	MS-031	04465-26051	A1N049	04466-07010	A2N057
00000A00984	MS-030	04465-26210	A1N036	04466-07011	A2N057
00000A01221	AS-030	04465-26300	A1N050	04466-07020	A2N057
00000A00983	LS-001	04465-26310	A1N050	04466-0C010	A2N159
0433-26-610A	AZ-019R	04465-26320	A1N050	04466-12010	A2N075
0433-26-710A	AZ-019L	04465-28040	A1N085	04466-12020	A2N075
04465-02070	A1N105	04465-28050	A1N083	04466-12030	A2N075
04465-02080	A1N105	04465-28170	A1N093	04466-12031	A2N075
04465-05010	A1N048	04465-28171	A1N093	04466-12040	A2N095
04465-10020	A1N043	04465-28180	A1N091	04466-12070	A2N075
04465-10040	A1N034	04465-28270	A1N083	04466-12080	A2N075
04465-10070	A1N043	04465-28350	A1N096	04466-12100	A2N076
04465-12010	A1N034	04465-28410	A1N101	04466-12110	A2N075
04465-12030	A1N034	04465-2B010	A1N065	04466-14010	A2N080
04465-12040	A1N034	04465-30030	A1N019	04466-14040	A2N027
04465-12070	A1N034	04465-30040	A1N019	04466-16010	A2N040
04465-12090	A1N034	04465-30080	A1N041	04466-17030	A2N044
04465-12140	A1N034	04465-30100	A1N019	04466-17040	A2N044
04465-12160	A1N053	04465-30110	A1N056	04466-17080	A2N044
04465-12240	A1N034	04465-30170	A1N019	04466-17090	A2N044
04465-12250	A1N034	04465-30270	A1N056	04466-18010	A2N040
04465-12490	A1N034	04465-30310	A1N056	04466-20020	A2N094
04465-12510	A1N034	04465-32050	A1N038	04466-20040	A2N081
04465-12540	A1N048	04465-32091	A1N038	04466-20050	A2N027
04465-12550	A1N034	04465-33020	A1N048	04466-20070	A2N081
04465-14080	A1N056	04465-33050	A1N048	04466-20080	A2N081
04465-14081	A1N056	04465-33060	A1N041	04466-20090	A2N007
04465-14150	A1N028	04465-33120	A1N097	04466-20110	A2N094
04465-16031	A1N034	04465-33130	A1N097	04466-20140	A2N081
04465-16070	A1N034	04465-35010	A1N036	04466-21010	A2N104
04465-16120	A1N034	04465-35020	A1N036	04466-22030	A2N080
04465-17021	A1N034	04465-35030	A1N021	04466-22040	A2N080
04465-17050	A1N053	04465-35031	A1N021	04466-22060	A2N057
04465-17070	A1N034	04465-35040	A1N021	04466-22070	A2N080
04465-17090	A1N034	04465-35080	A1N029	04466-22080	A2N080
04465-20020	A1N034	04465-35090	A1N017	04466-22090	A2N080
04465-20030	A1N034	04465-35120	A1N016	04466-22110	A2N080
04465-20050	A1N038	04465-35170	A1N017	04466-22140	A2N057
04465-20060	A1N034	04465-35190	A1N029	04466-22150	A2N030
04465-20080	A1N034	04465-35210	A1N017	04466-22160	A2N057
04465-20090	A1N038	04465-35220	A1N049	04466-22170	A2N030
04465-20100	A1N028	04465-35230	A1N029	04466-22180	A2N099
04465-20110	A1N048	04465-36050	A1N061	04466-22190-79	A2N118
04465-20120	A1N048	04465-42010	A1N048	04466-24010	A2N084
04465-20130	A1N048	04465-42011	A1N048	04466-24020	A2N084
04465-20140	A1N048	04465-42012	A1N048	04466-26010	A2N059
04465-20300	A1N034	04465-50060	A1N025	04466-26020	A2N059
04465-20310	A1N038	04465-50080	A1N041	04466-28010	A2N047
04465-20450	A1N048	04465-50110	A1N055	04466-28011	A2N047
04465-20480	A1N068	04465-52010	A1N068	04466-28020	A2N047
04465-22010	A1N016	04465-59010	A1N067	04466-28030	A2N069
04465-22020	A1N016	04465-59020	A1N067	04466-28040	A2N069
04465-22040	A1N020	04465-60020	A1N023	04466-28050	A2N069
04465-22060	A1N020	04465-60030	A1N021	04466-28070	A2N069
04465-22140	A1N016	04465-60060	A1N017	04466-28080	A2N069
04465-22180	A1N020	04465-60150	A1N005	04466-28090	A2N047
04465-26030	A1N049	04465-60170	A1N005	04466-30010	A2N080
04465-26040	A1N049	04465-YZZ52	A1N019	04466-30020	A2N084

# CROSS REFERENCE LIST

## OE N<sup>R</sup> TO AISIN N<sup>R</sup>

OE N <sup>R</sup>	AISIN N <sup>R</sup>	OE N <sup>R</sup>	AISIN N <sup>R</sup>	OE N <sup>R</sup>	AISIN N <sup>R</sup>
04466-30030	A2N059	04466-50120	A2N010	04491-12360	A1N034
04466-30050	A2N059	04466-51010	A2N099	04491-12361	A1N034
04466-30080	A2N057	04466-51011	A2N099	04491-12370	A1N034
04466-30100	A2N059	04466-51020	A2N099	04491-12421	A1N034
04466-30120	A2N099	04466-52010	A2N007	04491-12422	A1N034
04466-30122	A2N099	04466-52020	A2N007	04491-12431	A1N034
04466-30130	A2N099	04466-52030	A2N007	04491-12432	A1N034
04466-30140	A2N059	04466-52040	A2N007	04491-12450	A1N034
04466-30150	A2N099	04466-52050	A2N007	04491-12480	A1N034
04466-30151	A2N099	04466-52060	A2N007	04491-12490	A1N034
04466-30160	A2N099	04466-52090	A2N007	04491-12491	A1N034
04466-30161	A2N099	04466-53010	A2N118	04491-12510	A1N034
04466-30170	A2N099	04466-53010-79	A2N118	04491-12540	A1N034
04466-30170-79	A2N099	04466-60010	A2N012	04491-12541	A1N034
04466-30190	A2N099	04466-60020	A2N012	04491-12560	A1N034
04466-30210	A2N118	04466-60030	A2N004	04491-12561	A1N034
04466-30230	A2N118	04466-60040	A2N012	04491-12580	A1N034
04466-32010	A2N051	04466-60050	A2N012	04491-12581	A1N034
04466-32020	A2N094	04466-60060	A2N012	04491-12651	A1N048
04466-32030	A2N066	04466-60070	A2N004	04491-16040	A1N034
04466-32040	A2N066	04466-60090	A2N012	04491-16041	A1N034
04466-32050	A2N051	04466-60110	A2N004	04491-16052	A1N034
04466-33010	A2N081	04466-60120	A2N159	04491-17030	A1N034
04466-33040	A2N051	04470-2230	MW-2230	04491-17031	A1N034
04466-33050	A2N051	04470-3040	MW-3040	04491-17040	A1N034
04466-33090	A2N104	04470-3041	47210-10911-71	04491-17050	A1N034
04466-33100	A2N104	04470-4240	MW-4240	04491-17060	A1N034
04466-33110	A2N081	04471-30010	MWK-703	04491-17061	A1N034
04466-33140	A2N104	04471-30010-71	MWK-703	04491-17070	A1N034
04466-33150	A2N051	04479-12090	ET-009R	04491-17170	A1N053
04466-33160	A2N130	04491-10111	A1N043	04491-20191	A1N034
04466-33170	A2N104	04491-10131	A1N043	04491-20192	A1N034
04466-35010	A2N118	04491-10141	A1N043	04491-20220	A1N034
04466-40030	A2N080	04491-10220	A1N034	04491-20221	A1N034
04466-40040	A2N058	04491-10221	A1N034	04491-20250	A1N034
04466-42010	A2N031	04491-10230	A1N034	04491-20251	A1N034
04466-42020	A2N031	04491-10231	A1N034	04491-20310	A1N034
04466-42030	A2N031	04491-10240	A1N034	04491-20390	A1N036
04466-42040	A2N031	04491-12170	A1N034	04491-20391	A1N038
04466-42050	A2N031	04491-12230	A1N034	04491-20400	A1N034
04466-42060	A2N130	04491-12231	A1N034	04491-20401	A1N034
04466-48020	A2N104	04491-12240	A1N034	04491-20450	A1N034
04466-48030	A2N111	04491-12250	A1N034	04491-20451	A1N034
04466-48040	A2N111	04491-12270	A1N034	04491-20460	A1N034
04466-48060	A2N111	04491-12271	A1N034	04491-20461	A1N034
04466-48090	A2N111	04491-12290	A1N034	04491-20470	A1N034
04466-50010	A2N042	04491-12291	A1N034	04491-20471	A1N034
04466-50020	A2N058	04491-12292	A1N034	04491-20480	A1N038
04466-50030	A2N058	04491-12300	A1N034	04491-20481	A1N038
04466-50040	A2N059	04491-12301	A1N034	04491-20610	A1N034
04466-50041	A2N059	04491-12322	A1N034	04491-20620	A1N034
04466-50050	A2N058	04491-12330	A1N034	04491-20660	A1N038
04466-50051	A2N058	04491-12331	A1N034	04491-20670	A1N038
04466-50060	A2N058	04491-12340	A1N034	04491-20680	A1N038
04466-50070	A2N058	04491-12341	A1N034	04491-20690	A1N038
04466-50080	A2N058	04491-12342	A1N034	04491-20750	A1N034
04466-50090	A2N010	04491-12350	A1N034	04491-20790	A1N034
04466-50091	A2N010	04491-12351	A1N034	04491-20800	A1N034
04466-50110	A2N058	04491-12352	A1N034	04491-20801	A1N034



# CROSS REFERENCE LIST

## OE N<sup>R</sup> TO AISIN N<sup>R</sup>

OE N <sup>R</sup>	AISIN N <sup>R</sup>	OE N <sup>R</sup>	AISIN N <sup>R</sup>	OE N <sup>R</sup>	AISIN N <sup>R</sup>
04491-20820	A1N034	04491-30191	A1N019	04491-60090	A1N021
04491-20850	A1N038	04491-30200	A1N019	04491-60160	A1N023
04491-20880	A1N048	04491-30220	A1N019	04491-9201	G1N018
04491-20890	A1N048	04491-30230	A1N019	04491-97201	G1N018
04491-22140	A1N016	04491-30231	A1N019	04491-97205	G1N018
04491-22150	A1N016	04491-30240	A1N019	04491-97401	G1N018
04491-22160	A1N016	04491-30250	A1N019	04492-02010	A2N075
04491-22161	A1N016	04491-30260	A1N019	04492-07010	A2N057
04491-22162	A1N016	04491-30270	A1N019	04492-10010	A2N040
04491-22170	A1N016	04491-30300	A1N019	04492-12030	A2N076
04491-22171	A1N016	04491-30310	A1N019	04492-12031	A2N076
04491-22172	A1N016	04491-30320	A1N019	04492-12040	A2N075
04491-22180	A1N016	04491-32010	A1N034	04492-12041	A2N075
04491-22200	A1N016	04491-32011	A1N034	04492-12042	A2N075
04491-22210	A1N016	04491-32012	A1N034	04492-12051	A2N075
04491-22230	A1N016	04491-32030	A1N034	04492-12052	A2N075
04491-22260	A1N020	04491-32080	A1N034	04492-12060	A2N075
04491-22270	A1N020	04491-32131	A1N038	04492-12070	A2N075
04491-22280	A1N020	04491-32132	A1N038	04492-12080	A2N075
04491-22300	A1N016	04491-32150	A1N038	04492-12090	A2N075
04491-22310	A1N020	04491-32250	A1N038	04492-14080	A2N080
04491-22311	A1N020	04491-32280	A1N038	04492-14081	A2N080
04491-22340	A1N020	04491-32281	A1N038	04492-14090	A2N080
04491-22380	A1N016	04491-32301	A1N038	04492-14100	A2N080
04491-24010	A1N016	04491-33010	A1N048	04492-14110	A2N080
04491-24020	A1N016	04491-33011	A1N048	04492-14120	A2N080
04491-26040	A1N036	04491-33020	A1N041	04492-14130	A2N080
04491-26070	A1N036	04491-33030	A1N048	04492-14150	A2N084
04491-26071	A1N036	04491-33040	A1N041	04492-14160	A2N027
04491-26130	A1N036	04491-33042	A1N041	04492-14161	A2N027
04491-26131	A1N036	04491-33091	A1N041	04492-16010	A2N040
04491-26141	A1N036	04491-33100	A1N041	04492-17040	A2N044
04491-26151	A1N036	04491-33110	A1N041	04492-17050	A2N044
04491-26191	A1N036	04491-35050	A1N036	04492-17051	A2N044
04491-26240	A1N049	04491-35051	A1N036	04492-18010	A2N040
04491-26250	A1N049	04491-35060	A1N036	04492-20010	A2N081
04491-26261	A1N050	04491-35061	A1N036	04492-20011	A2N081
04491-26262	A1N050	04491-35062	A1N036	04492-20021	A2N081
04491-26270	A1N050	04491-35063	A1N036	04492-20030	A2N081
04491-26280	A1N049	04491-35070	A1N017	04492-20040	A2N081
04491-26310	A1N049	04491-35071	A1N017	04492-20050	A2N081
04491-26320	A1N050	04491-35080	A1N017	04492-20051	A2N081
04491-26340	A1N050	04491-35090	A1N016	04492-20060	A2N081
04491-27100	A1N078	04491-35091	A1N016	04492-20110	A2N027
04491-28112	A1N083	04491-35100	A1N017	04492-20140	A2N094
04491-28160	A1N083	04491-35120	A1N017	04492-20150	A2N081
04491-28170	A1N083	04491-35160	A1N021	04492-22040	A2N080
04491-28220	A1N085	04491-35170	A1N021	04492-22041	A2N080
04491-28270	A1N083	04491-351701	A1N021	04492-22042	A2N080
04491-28280	A1N085	04491-35171	A1N021	04492-22043	A2N080
04491-28350	A1N093	04491-35200	A1N036	04492-22090	A2N080
04491-28351	A1N093	04491-36010	A1N061	04492-22101	A2N080
04491-28370	A1N091	04491-42011	A1N048	04492-22110	A2N080
04491-2B010	A1N048	04491-50060	A1N034	04492-22111	A2N080
04491-2B040	A1N028	04491-60010	A1N017	04492-22120	A2N080
04491-2B050	A1N048	04491-60030	A1N017	04492-22121	A2N080
04491-2B060	A1N041	04491-60050	A1N017	04492-22130	A2N080
04491-30180	A1N019	04491-60070	A1N021	04492-22131	A2N080
04491-30190	A1N019	04491-60080	A1N021	04492-22140	A2N080

# CROSS REFERENCE LIST

## OE N<sup>R</sup> TO AISIN N<sup>R</sup>

OE N <sup>R</sup>	AISIN N <sup>R</sup>	OE N <sup>R</sup>	AISIN N <sup>R</sup>	OE N <sup>R</sup>	AISIN N <sup>R</sup>
04492-22141	A2N080	06430-S3N-J00	C2N021	2469-43-400	MZ-037
04492-22150	A2N057	06430-S5A-J00	C2N015	2469-43-400A	MZ-037
04492-22160	A2N057	06430-S6D-000	C2N015	2469-43-400B	MZ-037
04492-24060	A2N084	06430-S6D-E50	C2N015	25110-GA180	EF-006R
04492-24070	A2N084	06430-S7A-J00	C2N021	25110-GA190	EF-006L
04492-24080	A2N084	06430-S7S-000	C2N021	25110-GA370	EF-005R
04492-24090	A2N059	06430-SAA-J50	C2N022	25110-GA371	EF-005R
04492-24100	A2N084	06430-SCV-A00	C2N021	25110-GA380	EF-005L
04492-28010	A2N047	06430-SED-000	C2N021	25110-GA381	EF-005L
04492-28020	A2N047	06430-SED-E50	C2N021	25110-GA382	EF-007L
04492-30110	A2N080	0660-26-510	AZ-025D	25177-GA340	AF-004
04492-30111	A2N080	0660-26-510C	AZ-025D	25177-GA350	AF-005
04492-30120	A2N080	0660-26-510D	AZ-025D	25177-GA360	AF-006
04492-30130	A2N080	0660-33-510	AZ-028F	25191-GA600	EF-004R
04492-30140	A2N059	0662-33-410	AZ-032RF	25191-GA610	EF-004L
04492-30150	A2N084	069021740	AN-053	25721-GA441	MF-009
04492-30160	A2N059	069030110	AN-053	25721-GA442	MF-009
04492-30161	A2N059	069041420	AN-054	25721-GA443	MF-009
04492-32010	A2N081	069052380	AN-907	25721-GA461	MF-003
04492-32011	A2N081	06905238-0	AN-907	25721-GA462	MF-003
04492-32020	A2N081	069053150	LN-003	25721-GA463	MF-003
04492-32040	A2N081	0778-26-610	AZ-027	25731GA441	MF-009
04492-32041	A2N081	0778-26-610B	AZ-027	26211-KC000	47710-6210
04492-40020	A2N080	0813-26-610A	AZ-013	26211-KC010	47720-6210
04492-40030	A2N080	0813-26-610B	AZ-013	26211-KC020	47710-6220
04492-50010	A2N042	0813-26-610C	AZ-013	26211-KC030	47720-6220
04492-50011	A2N042	0813-26-610D	AZ-013	26221KA050	AF-008
04492-50020	A2N058	0K011-26-610	AK-002	26221KA051	AF-008
04492-50030	A2N058	0K011-43-400	MK-003	26221KA052	AF-008
04492-50040	A2N059	0K045-26-610	AK-004	26221-TA021	AF-007
04492-50050	A2N058	0K201-26-610A	AK-001	26256AA000	AF-009
04492-50060	A2N059	0K552-26-610	AK-002	26256AA001	AF-009
04492-50070	A2N058	0ST20-43-400B	MK-001	26256AA010	AF-010
04492-50071	A2N058	1393-43-400	MZ-031	26256AA011	AF-010
04492-50080	A2N058	1524-43-400A	MZ-010	26296-AA020	F1N010
04492-60010	A2N012	1620-43-990A	MZ-009	26296-AA041	F1N011
04492-60020	A2N012	16300282-1	MN-904	26296AA060	F2N012
04492-87101	G2N010	16300283-0	MN-904	26296-AA060	F2N012
04492-87101-000	G2N010	1745-26-610	AZ-016R	26296AA061	F2N012
04492-87102-000	G2N010	1745-26-610A	AZ-016R	26296-AA061	F2N012
04492-87201-000	E2N032	1745-26-710	AZ-016L	26296AA062	F2N012
04492-87202-000	E2N032	1745-26-710A	AZ-016L	26296-AA062	F2N012
04492-87705-000	E2N032	17680000	AS-013	26296AA080	F2N012
04492-87706-000	E2N032	1A00-26-43Z	C2N022	26296-AA080	F2N012
04492-87707-000	E2N032	1A00-26-43ZA	C2N022	26296AA081	F2N012
0589-26-610E	AZ-029R	1E0326610	AZ-035	26296-AA081	F2N012
0589-26-710E	AZ-029L	1E0426610	AZ-035	26296AA082	F2N012
0589-33-610	AZ-028RFL	1E0626610	AE-FO01	26296-AA082	F2N012
0589-33-710	AZ-028LFL	1U00-26-48Z	E2N030	26296-AA100	F1N010
06022-SP8-000	C2N022	1U01-26-48Z	E2N032	26296-AA120	F1N010
0603-26-610A	AZ-026R	1U03-26-48Z	E2N032	26296-AA121	F1N010
0603-26-710A	AZ-026L	1U04-26-48Z	E2N033	26296-AA141	F1N010
0603-33-610A	AZ-028RFL	1U06-26-48Z	E2N033	26296-AA142	F1N010
0603-33-710	AZ-028LFL	1U07-26-48Z	E2N033	26296-AA143	F1N010
0613-26-610A	AZ-012	1U08-26-48Z	E2N033	26296-AC010	F1N014
06430-S0A-J00	C2N015	1U0J-26-48Z	G2N010	26296-AC020	F1N014
06430-S0K-J01	C2N021	1U0K-26-48Z	E2N030	26296-AC050	F1N013
06430-S2A-000	C2N015	1U0N-26-48Z	E2N033	26296-FA000	F1N010
06430-S2X-J00	C2N021	1E0426610A	AZ-036	26296-FA001	F1N010

# CROSS REFERENCE LIST

## OE N<sup>R</sup> TO AISIN N<sup>R</sup>

OE N <sup>R</sup>	AISIN N <sup>R</sup>	OE N <sup>R</sup>	AISIN N <sup>R</sup>	OE N <sup>R</sup>	AISIN N <sup>R</sup>
26296-FC000	F2N015	41000-V1700	EN-041R	41001-77S06	EN-021R
26296-FC001	F2N015	41000-W1000	EN-001R	41001-80E01	EN-076R
26296PA040	F2N012	41000-W1010	EN-001R	41001-88E00	EN-077R
26296PA060	F2N012	41000-W1011	EN-001R	41001-88E01	EN-077R
26401AA230	ME-CI01	41000-W2300	EN-044R	41001-88E02	EN-077R
26401-AA350	MF-012	41000-W2301	EN-044R	41001-94M10	EN-030R
26401-AA351	MF-012	41000-Y4101	EN-041R	41001-C7801	EN-025R
26401-AA352	MF-012	41001-01A00	EN-027R	41001-C7811	EN-025R
26401-AA353	MF-012	41001-01A01	EN-027R	41001-D0190	EN-034R
26401-AA354	MF-012	41001-01A90	EN-027R	41001-D0191	EN-035R
26401-AA400	MF-005	41001-01J00	EN-023R	41001-D1490	EN-036R
26401-AA401	MF-005	41001-01J01	EN-023R	41001-D1491	EN-037R
26401-AA410	MF-004	41001-03N00	EN-039R	41001-G4091	EN-042R
26401AA411	MF-004	41001-03N01	EN-039R	41001-G4290	EN-043R
26401-AC121	MF-900	41001-03P00	EN-062R	41001-N7190	EN-073R
26401-AC190	MF-014	41001-04C02	EN-040R	41001-R8205	EN-065R
26401-AC191	MF-014	41001-05A90	EN-028R	41001-R9090	EN-079R
26401-FA010	MF-011	41001-06E90	EN-004R	41001-T7890	EN-009R
26401-FA011	MF-011	41001-06E91	EN-004R	41001-U8790	EN-041R
26401-FA012	MF-011	41001-07S91	EN-056R	41001-V7000	EN-018R
26401-FA013	MF-011	41001-08E90	EN-003R	41001-V7001	EN-018R
26401-FA014	MF-011	41001-08E91	EN-003R	41001-V7004	EN-018R
26401-FA030	MF-011	41001-08N01	EN-066R	41001-W2291	EN-032R
26401-FA031	MF-011	41001-08N02	EN-066R	41001-W6590	EN-072R
26420-PA030	MF-013	41001-08N03	EN-066R	41001-Y4190	EN-041R
26696AE000	F2N015	41001-09W00	EN-017R	41010-11L01	EN-019L
26696AE020	F2N015	41001-09W02	EN-017R	41010-11L02	EN-019L
26696AE040	F2N015	41001-09W90	EN-017R	41010-11L12	EN-020L
26696AE080	F2N015	41001-09W91	EN-017R	41010-C7161	EN-067L
26696AG020	F2N015	41001-09W93	EN-017R	41010-F5010	EN-002L
26696FA010	F2N015	41001-10G02	EN-075R	41010-F5011	EN-002L
26696FC000	F2N015	41001-13E00	EN-005R	41010-H8700	EN-049L
26696FC001	F2N015	41001-13E01	EN-005R	41010-H9300	EN-038L
26696FC002	F2N015	41001-16R91	EN-048R	41010-M7910PL	EN-047L
26696FE040	F2N016	41001-20J01	EN-024R	41010-P9101	EN-057L
26696-FE040	F2N016	41001-21T00	EN-010R	41010-R8201	EN-079L
26696FE050	F2N016	41001-21T01	EN-010R	41010-R8203	EN-079L
26696KE000	B2N026	41001-22T00	EN-008R	41010-S3401	EN-041L
2677-43-400A	MZ-038	41001-22T01	EN-008R	41010-S3402	EN-041L
31410-22001-71	LT-001	41001-26E60	EN-005R	41010-U8900	EN-041L
31440-36080	BBT-082	41001-26E63	EN-005R	41010-V1700	EN-041L
31510-13002-71	LW-003	41001-31E02PL	EN-055R	41010-W1000	EN-001L
3958-43-400	MZ-011	41001-32R00	EN-078R	41010-W1010	EN-001L
40140-5011	LT-001	41001-32R01	EN-078R	41010-W1011	EN-001L
40160-5252	LW-003	41001-37J00	EN-074R	41010-W2300	EN-044L
41000-11L01	EN-019R	41001-44F01	EN-022R	41010-W2301	EN-044L
41000-11L02	EN-019R	41001-49L92	EN-017R	41010-Y4101	EN-041L
41000-11L12	EN-020R	41001-50Y00	EN-031R	41011-01A00	EN-027L
41000-C7161	EN-067R	41001-50Y01	EN-031R	41011-01A01	EN-027L
41000-F5010	EN-002R	41001-50Y02	EN-031R	41011-01A90	EN-027L
41000-F5011	EN-002R	41001-58A01	EN-029R	41011-01J00	EN-023L
41000-H8700	EN-049R	41001-60Y00	EN-026R	41011-01J01	EN-023L
41000-H9300	EN-038R	41001-60Y01	EN-026R	41011-03N00	EN-039L
41000-M7910PL	EN-047R	41001-60Y02	EN-026R	41011-03N01	EN-039L
41000-P9101	EN-057R	41001-61A01	EN-028R	41011-03P00	EN-062L
41000-R8202	EN-079R	41001-62A01	EN-050R	41011-04C02	EN-040L
41000-R8203	EN-079R	41001-70J00	EN-080R	41011-05A90	EN-028L
41000-S3402	EN-041R	41001-71E02	EN-053R	41011-06E90	EN-004L
41000-U8900	EN-041R	41001-76A00	EN-051R	41011-06E91	EN-004L

# CROSS REFERENCE LIST

## OE N<sup>R</sup> TO AISIN N<sup>R</sup>

OE N <sup>R</sup>	AISIN N <sup>R</sup>	OE N <sup>R</sup>	AISIN N <sup>R</sup>	OE N <sup>R</sup>	AISIN N <sup>R</sup>
41011-07S90	EN-056L	41011-U8790	EN-041L	41100-18000	AN-046RFA
41011-08E90	EN-003L	41011-V7000	EN-018L	41100-B5001	AN-030RF
41011-08E91	EN-003L	41011-V7001	EN-018L	41100-B5010	AN-030RF
41011-08N01	EN-066L	41011-V7004	EN-018L	41100-B9600	AN-045RFA
41011-08N02	EN-066L	41011-VB200	EN-082L	41100-C6000	AN-033RF
41011-08N03	EN-066L	41011-W2291	EN-032L	41100-C7800	AN-033RF
41011-09W00	EN-017L	41011-W6590	EN-072L	41100-R8010	AN-045RFA
41011-09W02	EN-017L	41011-Y4190	EN-041L	41101-B5001	AN-030LF
41011-09W90	EN-017L	41060-04B91	B1N012	41101-B5010	AN-030LF
41011-09W91	EN-017L	41060-04C85	B1N004	41101-B9600	AN-045RFB
41011-09W93	EN-017L	41060-0E591	B1N020	41101-C6000	AN-033LF
41011-10G02	EN-075L	41060-0M891	B1N025	41101-C7800	AN-033LF
41011-13E00	EN-005L	41060-0M892	B1N025	41101-H1000	AN-046RFB
41011-13E01	EN-005L	41060-0M893	B1N025	41101-R8010	AN-045RFB
41011-16R91	EN-048L	41060-11P26	B1N003	41102-18000	AN-046LFA
41011-20J01	EN-024L	41060-11P85	B1N003	41102-B9600	AN-045LFA
41011-21T00	EN-010L	41060-11P91	B1N004	41102-R8010	AN-045LFA
41011-21T01	EN-010L	41060-11P93	B1N004	41103-B9600	AN-045LFB
41011-22T00	EN-008L	41060-11P94	B1N004	41103-H1000	AN-046LFB
41011-22T01	EN-008L	41060-13E85	B1N004	41103-R8010	AN-045LFB
41011-26E60	EN-005L	41060-16C90	B1N003	41110-01B01	EN-046R
41011-26E63	EN-005L	41060-1W385	B1N062	41120-01B01	EN-046L
41011-31E02PL	EN-055L	41060-31E85	B1N003	426296	MO-018
41011-32R00	EN-078L	41060-31E86	B1N003	426298	MO-016
41011-32R01	EN-078L	41060-31E88	B1N003	426320	MO-017
41011-37J00	EN-074L	41060-31E89	B1N004	426321	MO-006
41011-44F00	EN-022L	41060-31E90	B1N003	426503	MO-007
41011-44F01	EN-022L	41060-31E93	B1N003	426504	MO-011
41011-49L92	EN-017L	41060-32E91	B1N003	426507	MO-009
41011-50Y00	EN-031L	41060-32G91	B1N011	426508	MO-013
41011-50Y01	EN-031L	41060-32G92	B1N011	426510	MO-019
41011-50Y02	EN-031L	41060-32R90	B1N020	426570	MO-010
41011-58A01	EN-029L	41060-37G93	B1N003	426571	MO-014
41011-60Y00	EN-026L	41060-3S590	B1N011	426695	MO-022
41011-60Y01	EN-026L	41060-40U90	B1N019	427166	MO-007
41011-60Y02	EN-026L	41060-40U92	B1N019	427167	MO-011
41011-61A01	EN-028L	41060-56L25	B1N003	427168	MO-021
41011-62A01	EN-050L	41060-58G90	B1N011	43022-S04-000	C2N022
41011-70J00	EN-080L	41060-58Y85	B1N054	43022-S04-010	C2N022
41011-71E01	EN-053L	41060-58Y87	B1N054	43022-S04-020	C2N022
41011-76A00	EN-051L	41060-61A90	B1N009	43022-S04-030	C2N022
41011-77S06	EN-021L	41060-62A91	B1N009	43022-S04-E00	C2N022
41011-80E01	EN-076L	41060-65E90	B1N020	43022-S04-E01	C2N022
41011-88E00	EN-077L	41060-65E91	B1N020	43022-S2A-000	C2N015
41011-88E01	EN-077L	41060-6P085	B1N062	43022-S3N-000	C2N021
41011-88E02	EN-077L	41060-71E90	B1N020	43022-S5A-J00	C2N015
41011-94M10	EN-030L	41060-78E90	B1N020	43022-S6D-000	C2N015
41011-C7801	EN-025L	41060-78E91	B1N020	43022-S6D-E50	C2N015
41011-C7811	EN-025L	41060-78J90	B1N020	43022-S7S-010	C2N021
41011-D0190	EN-034L	41060-G8190	B1N020	43022-S9A-010	C2N061
41011-D0191	EN-035L	41060-G8191	B1N020	43022-SAA-J50	C2N022
41011-D1490	EN-036L	41060-V5786	B1N003	43022-SCV-A00	C2N021
41011-D1491	EN-037L	41060-V5788	B1N003	43022-SD2-317	C2N022
41011-G4091	EN-042L	41060-V5789	B1N003	43022-SED-000	C2N021
41011-G4290	EN-043L	41060-V6791	B1N003	43022-SED-E50	C2N021
41011-N7190	EN-073L	41060-V6794	B1N003	43022-SF1-010	C2N010
41011-R8205	EN-065L	41060-V7085	B1N011	43022-SF1-505	C2N022
41011-R9090	EN-079L	41060-V7090	B1N011	43022-SF1-515	C2N022
41011-T7890	EN-009L	41060-VB290	B1N018	43022-SF1-525	C2N022

# CROSS REFERENCE LIST

## OE N<sup>R</sup> TO AISIN N<sup>R</sup>

OE N <sup>R</sup>	AISIN N <sup>R</sup>	OE N <sup>R</sup>	AISIN N <sup>R</sup>	OE N <sup>R</sup>	AISIN N <sup>R</sup>
43022-SF1-S00	C2N010	43022-SV4-A21	C2N015	43230-SE0-935	EH-001LR
43022-SF1-S01	C2N010	43022-SV4-A22	C2N015	43230-SE0-936	EH-001LR
43022-SG0-010	C2N015	43022-SV4-G00	C2N015	43230-SE0-937	EH-001LR
43022-SG0-020	C2N015	43022-SV4-G01	C2N015	43230-SE0-N50	EH-001LR
43022-SG0-505	C2N015	43022-SV4-G02	C2N015	43230-SE0-S01	EH-017L
43022-SH3-305	C2N022	43022-SV4-G20	C2N015	43230-SF0-033	EH-027LR
43022-SH3-507	C2N022	43022-SV4-G21	C2N015	43230-SF0-N50	EH-027LR
43022-SH3-930	C2N022	43022-SV4-G22	C2N015	43230-SK7-023	EH-016L
43022-SH3-931	C2N022	43022-SX0-A50	C2N021	43230-SK7-033	EH-016L
43022-SH3-932	C2N022	43022-SX0-A51	C2N021	43230-SL4-950	EH-004L
43022-SH3-G00	C2N022	43022-SX0-A52	C2N021	43230-SL4-951	EH-004L
43022-SH3-G01	C2N022	43022-SY8-A00	C2N015	43230-SL5-A01	EH-036LR
43022-SH3-J00	C2N022	43022-SY8-A01	C2N015	43230-SM4-951	EH-004L
43022-SH3-N30	C2N022	43022-SZ3-A00	C2N021	43230-SM4-952	EH-004L
43022-SJF-000	C2N021	43022-SZ3-A01	C2N021	43230-SM4-953	EH-004L
43022-SL5-000	C2N015	43030SP8000	AH-019R	43230-SM4-954	EH-004L
43022-SL5-305	C2N015	43031SP8000	AH-019L	43230-SM4-G01	EH-004L
43022-SL5-505	C2N015	43210-SB0-952	EH-024RR	43230-SM4-G02	EH-004L
43022-SL5-515	C2N015	43210-SB0-N50	EH-024RR	43230-SM4-G03	EH-004L
43022-SL5-525	C2N015	43210-SD2-932	EH-012R	43230-SM4-G04	EH-004L
43022-SM4-305	C2N015	43210-SD2-934	EH-012R	43230-SM-G64	EH-005L
43022-SM4-505	C2N015	43210-SD2-935	EH-012R	43230-SR3-013	EH-010L
43022-SM4-515	C2N015	43210-SE0-931	EH-001RR	43230-SR3-G02	EH-009L
43022-SM4-525	C2N015	43210-SE0-932	EH-001RR	43300-634-003	AH-007
43022-SM4-950	C2N015	43210-SE0-933	EH-001RR	43300-634-670	43300-634-670
43022-SM4-G00	C2N015	43210-SE0-934	EH-001RR	43300-634-931	43300-634-670
43022-SM5-A00	C2N015	43210-SE0-935	EH-001RR	43300-671-601	AH-009
43022-SN7-000	C2N015	43210-SE0-936	EH-001RR	43300-671-602	AH-009
43022-SP0-000	C2N021	43210-SE0-937	EH-001RR	43300-671-632	AH-006
43022-SP0-010	C2N021	43210-SE0-N50	EH-001RR	43300-671-633	AH-006
43022-SP0-020	C2N021	43210-SE0-S01	EH-017R	43300-679-931	AH-007
43022-SP0-305	C2N021	43210-SF0-033	EH-027RR	43300680931	AH-016R
43022-SP0-E00	C2N021	43210-SF0-N50	EH-027RR	43300-692-003	AH-005R
43022-SP0-E01	C2N021	43210-SK7-023	EH-016R	43300-692-013	AH-005R
43022-SR2-000	C2N022	43210-SK7-033	EH-016R	43300-S04-003	AH-003R
43022-SR2-010	C2N022	43210-SL4-950	EH-004R	43300-SA0-003	AH-013R
43022-SR2-030	C2N022	43210-SL4-951	EH-004R	43300-SA3-681	AH-001R
43022-SR3-000	C2N022	43210-SL5-A01	EH-036RR	43300SAAG01	AH-017
43022-SR3-010	C2N022	43210-SM4-951	EH-004R	43300-SB2-003	AH-002R
43022-SR3-020	C2N022	43210-SM4-952	EH-004R	43300-SE0-003	AH-004
43022-SR3-030	C2N022	43210-SM4-953	EH-004R	43300-SE0-013	AH-004
43022-SR3-305	C2N022	43210-SM4-954	EH-004R	43300-SE1-003	AH-010
43022-SR3-G00	C2N022	43210-SM4-G01	EH-004R	43300SF4003	AH-002R
43022-SR3-G01	C2N022	43210-SM4-G02	EH-004R	43300-SH3-J01	AH-003R
43022-SS1-000	C2N022	43210-SM4-G03	EH-004R	43300-SH5-003	AH-008
43022-SS1-010	C2N022	43210-SM4-G04	EH-004R	43300-SH5-013	AH-012
43022-SS1-020	C2N022	43210-SM4-G64	EH-005R	43300SJ8003	AH-018
43022-ST3-E00	C2N022	43210-SR3-013	EH-010R	43300SM4A01	AH-003R
43022-ST7-000	C2N022	43210-SR3-G02	EH-009R	43300-SR3-003	AH-003R
43022-ST7-A00	C2N022	43230-SB0-951	EH-024LR	43300ST3E01	AH-015R
43022-SV4-000	C2N015	43230-SB0-952	EH-024LR	43300ST3E010	AE-RO02R
43022-SV4-010	C2N015	43230-SB0-N50	EH-024LR	43301-692-003	AH-005L
43022-SV4-020	C2N015	43230-SD2-932	EH-012L	43301-692-013	AH-005L
43022-SV4-030	C2N015	43230-SD2-934	EH-012L	43301S04003	AH-003L
43022-SV4-305	C2N015	43230-SD2-935	EH-012L	43301-SA0-003	AH-013L
43022-SV4-A00	C2N015	43230-SE0-931	EH-001LR	43301-SA3-681	AH-001L
43022-SV4-A01	C2N015	43230-SE0-932	EH-001LR	43301-SB2-003	AH-002L
43022-SV4-A02	C2N015	43230-SE0-933	EH-001LR	43301-SH3-003	AH-003L
43022-SV4-A20	C2N015	43230-SE0-934	EH-001LR	43301-SH3-J01	AH-003L



# CROSS REFERENCE LIST

## OE N<sup>R</sup> TO AISIN N<sup>R</sup>

OE N <sup>R</sup>	AISIN N <sup>R</sup>	OE N <sup>R</sup>	AISIN N <sup>R</sup>	OE N <sup>R</sup>	AISIN N <sup>R</sup>
43301SM4A01	AH-003L	44060-0P691	B2N057	44060-AU091	B2N040
43301-SR3-003	AH-003L	44060-0P692	B2N057	44060-CB10J	B2N064
43301ST3E01	AH-015L	44060-10V85	B2N045	44060-D3590	B2N008
43301ST3E010	AE-RO02L	44060-10V87	B2N045	44060-EG086	B2N064
44000-04S03	EN-054RR	44060-10V88	B2N045	44060-F6686	B2N045
44000N4601	AN-008	44060-21P85	B2N045	44060-P9125	B2N016
44000-N9501	EN-054RR	44060-31U90	B2N022	44060-P9194	B2N016
44000-P7200	EN-058RR	44060-31U91	B2N022	44060-V6786	B2N045
44000-P9102	EN-059RR	44060-31U92	B2N022	44100-01A00	AN-044
44000-P9403	EN-060R	44060-32G85	B2N050	44100-01A01	AN-044
44000-P9612	EN-061RR	44060-35F92	B2N016	44100-01A02	AN-044
44000-V1403	EN-081RR	44060-41L85	B2N045	4410001AOO	AN-044
44001-04S90	EN-033R	44060-43P85	B2N053	4410001J10	AN-007
44001-05J00	EN-068RR	44060-44B90	B2N026	44100-01J11	AN-007
44001-06P90	EN-063RR	44060-45L85	B2N045	44100-01W01	AN-026
44001-07P90	EN-064RR	44060-4U010	B2N040	44100-03W01	AN-028
44001-08E90	EN-006R	44060-4U090	B2N022	44100-04B00	AN-002
44001-21F90	EN-070RR	44060-4U092	B2N040	44100-04B02	AN-002
44001-50A00	EN-052RR	44060-53F92	B2N016	44100-05N10	AN-035
44001-58Y00	EN-076RR	44060-54C90	B2N022	44100-05W01	AN-027
44001-61E01	EN-071RR	44060-54C91	B2N022	44100-08G10	AN-004
44001-62C00	EN-045R	44060-58S85	B2N045	44100-08G11	AN-036
44001-78N00	EN-085RR	44060-5L325	B2N056	4410008G12	AN-004
44001-D3502	EN-007R	44060-60F90	B2N016	44100-08W10	AN-029
44001-D3503	EN-007R	44060-61J90	B2N022	44100-08W11	AN-029
44001-VB200	EN-083RR	44060-61U88	B2N057	44100-08W12	AN-009
44010-04S03	EN-054LR	44060-63C90	B2N022	4410008W14	AN-009
44010-N9501	EN-054LR	44060-6E390	B2N022	44100-08W20	AN-047
44010-P7200	EN-058LR	44060-6P085	B2N057	44100-08W21	AN-047
44010-P9102	EN-059LR	44060-6U390	B2N040	44100-08W22	AN-041
44010-P9403	EN-060L	44060-6Y390	B2N040	44100-0F000	AN-906
44010-P9611	EN-061LR	44060-70T85	B2N056	441000F001	AN-053
44010-V1403	EN-081LR	44060-71L85	B2N045	441000X900	AN-052
44011-04S90	EN-033L	44060-71L86	B2N056	44100-13A00	AN-012
44011-05J00	EN-068LR	44060-73C90	B2N022	44100-13A01	AN-012
44011-06P90	EN-063LR	44060-73C91	B2N022	44100-13A02	AN-012
44011-07P90	EN-064LR	44060-75C90	B2N022	44100-17C10	AN-013
44011-08E90	EN-006L	44060-78N90	B2N022	4410017C11	AN-013
44011-0N600	EN-084LR	44060-78N91	B2N022	4410017C12	AN-013
44011-21F90	EN-070LR	44060-7E690	B2N022	44100-31G10	AN-037
44011-50A00	EN-052LR	44060-85F90	B2N016	44100-35G10	AN-005
44011-58Y00	EN-076LR	44060-85L85	B2N056	4410037G10	AN-003
44011-61E01	EN-071LR	44060-85L86	B2N056	44100-37G11	AN-003
44011-62C00	EN-045L	44060-87N90	B2N022	4410037G12	AN-003
44011-78N00	EN-085LR	44060-87N91	B2N022	44100-3F000	AN-902R
44011-D3501	EN-007L	44060-8H385	B2N064	44100-3J310	AN-903
44011-D3502	EN-007L	44060-9V590	B2N016	441003T010	AN-054
44011-D3503	EN-007L	44060-A1190	B2N016	44100-48W10	AN-038
44060-01P25	B2N016	44060-A1588	B2N045	44100-48W11	AN-038
44060-01P90	B2N016	44060-A1690	B2N008	44100-50C10	AN-011
44060-01P92	B2N016	44060-AA525	B2N053	44100-50C11	AN-011
44060-01P93	B2N016	44060-AA585	B2N053	4410050C12	AN-011
44060-04U85	B2N053	44060-AA586	B2N053	44100-51S10	AN-008
44060-08E91	B2N008	44060-AG085	B2N057	44100-55S10	AN-020
44060-08G11	B2N050	44060-AG088	B2N057	44100-5F600	AN-904
44060-0H085	B2N045	44060-AG089	B2N056	4410060A10	AN-050
44060-0M890	B2N029	44060-AL586	B2N064	4410060A12	AN-050
44060-0N690	B2N022	44060-AR085	B2N057	44100-6F611	AN-904
44060-0P690	B2N057	44060-AU090	B2N040	44100-70J20	AN-901R

# CROSS REFERENCE LIST

## OE N<sup>R</sup> TO AISIN N<sup>R</sup>

OE N <sup>R</sup>	AISIN N <sup>R</sup>	OE N <sup>R</sup>	AISIN N <sup>R</sup>	OE N <sup>R</sup>	AISIN N <sup>R</sup>
44100-70J22	AN-052R	44610-26431	BBT-055	44610-60421	BBT-060
44100-7F000	AN-049	44610-26441	BBT-062	44610-60460	BBT-042
44100-99B12	AN-904	44610-26450	BBT-052	44610-60470	BBT-061
44100AX600	AN-051	44610-27350	BBT-044	44610-60500	BBT-022
44100-B5000	AN-043	44610-28730	BBT-049	44610-60540	BBT-027
44100-C6000	AN-034	44610-2D090	BBT-056	44610-60570	BBT-036
44100-C7100	AN-001	44610-2G101	BBT-078	44610-60580	BBT-035
44100-C7101	AN-001	44610-30650	BBT-059	44610-60740	BBT-053
44100-D0110	AN-017	44610-30A00	BBT-089	44610-60741	BBT-041
44100-D0111	AN-017	44610-33150	BBT-011	44610-60771	BBT-043
44100-D0112	AN-017	44610-33430	BBT-031	44610-60772	BBT-018
44100-D5510	AN-010	44610-33510	BBT-090	44610-60783	BBT-096
44100-F1700	AN-022R	44610-33710	BBT-074	44610-60801	BBT-017
44100-G2800	AN-042	44610-35550	BBT-065	44610-60802	BBT-016
44100-G5110	AN-016	44610-35660	BBT-021	44610-60822	BBT-032
44100-G5510	AN-006	44610-35680	BBT-001	44610-60880	BBT-014
44100-G9825	AN-905	44610-35690	BBT-064	44610-6A060	BBT-058
44100-H3100	AN-048	44610-35710	BBT-051	44610-6A070	BBT-069
44100-H3300	AN-032	44610-35720	BBT-028	44610-6A140	BBT-076
44100-M0205	AN-014R	44610-35860	BBT-009	44610-6A150	BBT-077
44100-M7000	AN-015	44610-36190	BBT-023	44610-6A170	BBT-080
44100-N3001	AN-024R	44610-36201	BBT-030	44610-6A182	BBT-085
44100-N4601	AN-008	44610-36250	BBT-026	44610-87309	BBD-001
44100-N4602	AN-025	44610-36251	BBT-026	44610-87314	BBD-002
44100-Q3110	AN-020	44610-38010	BBT-068	44610-87317	BBD-003
44100-T3260	AN-031	44610-38071	BBT-073	44610-87318	BBD-006
44100-T6000	AN-039	44610-38080	BBT-091	44610-87320	BBD-005
44100-T6001	AN-039	44610-38090	BBT-092	44610-87503	BBD-010
44100-T6213	AN-040	44610-3A151	BBT-081	44610-87506	BBD-008
44100-U4600	AN-018R	44610-3D091	BBT-003	44610-87510	BBD-011
44100-U8710	AN-019	44610-3D121	BBT-034	44610-87511	BBD-007
44100-U9200	AN-013	44610-3D130	BBT-038	44610-87514	BBD-004
44100-V0201	AN-023	44610-3D131	BBT-048	44610-87519	BBD-012
44101-3F000	AN-902L	44610-3D311	BBT-057	44610-87613	BBD-009
44101-3J310	AN-903	44610-3D730	BBT-094	44610-97501	BBD-013
44101-70J20	AN-901L	44610-3D770	BBT-010	45018-SF1-003	EH-034R
4410170J22	AN-052L	44610-43011	BBT-095	45018-SH3-G33	EH-021R
44101-F1700	AN-022L	44610-48230	BBT-086	45018-SH3-N32	EH-022R
44101-M0205	AN-014L	44610-48240	BBT-087	45018-SK7-003	EH-013R
44101-N3001	AN-024L	44610-48270	BBT-088	45019-SF1-003	EH-034L
44101-U4600	AN-018L	44610-50010	BBT-075	45019-SH3-G33	EH-021L
44160-14630	BBT-072	44610-52242	BBT-079	45019-SH3-N32	EH-022L
44160-26080	BBT-071	44610-52323	BBT-083	45019-SK7-003	EH-013L
441610-3D770	BBT-010	44610-58011	BBT-084	45022-S04-V10	C1N016
4460-85L85	B2N056	44610-60030	BBT-054	45022-S04-V11	C1N016
4461009060	LT-003	44610-60060	BBT-039	45022-S04-V12	C1N016
4461009070	LT-005	44610-60080	BBT-006	45022-S30-G10	C1N023
4461009080	LT-004	44610-60110	BBT-070	45022-SA5-010	C1N004
44610-12270	BBT-040	44610-60130	BBT-050	45022-SD2-505	C1N033
44610-12540	BBT-063	44610-60160	BBT-002	45022-SD2-506	C1N033
44610-14630	BBT-072	44610-60190	BBT-037	45022-SD2-A01	C1N033
44610-20720	BBT-019	44610-60250	BBT-025	45022-SD2-A02	C1N033
44610-22260	BBT-033	44610-60260	BBT-067	45022-SD2-A10	C1N033
44610-22360	BBT-007	44610-60270	BBT-046	45022-SD2-A11	C1N033
44610-22460	BBT-005	44610-60310	BBT-020	45022-SD2-A12	C1N033
44610-22611	BBT-066	44610-60320	BBT-024	45022-SD2-A13	C1N033
44610-22730	BBT-008	44610-60350	BBT-029	45022-SD4-000	C1N013
44610-25190	BBT-045	44610-60360	BBT-047	45022-SD4-020	C1N013
44610-26080	BBT-071	44610-60370	BBT-004	45022-SD4-A13	C1N013



# CROSS REFERENCE LIST

## OE N<sup>R</sup> TO AISIN N<sup>R</sup>

OE N <sup>R</sup>	AISIN N <sup>R</sup>	OE N <sup>R</sup>	AISIN N <sup>R</sup>	OE N <sup>R</sup>	AISIN N <sup>R</sup>
45022-SD4-E00	C1N013	45210-SD4-674	EH-013R	45370-679-003	AH-011LFB
45022-SE0-315	C1N033	45210-SD4-675	EH-013R	4601000QAF	MN-138
45022-SE0-912	C1N033	45210-SE0-A13	EH-025R	46010-01A00	MN-016
45022-SE0-G10	C1N013	45210-SG0-G13	EH-030R	46010-01A05	MN-016
45022-SG0-G10	C1N013	45210-SG0-J01	EH-031RR	46010-01B05	MN-117
45022-SG0-G11	C1N013	45210-SH3-023	EH-006R	46010-01G00	MN-012
45022-SH3-G00	C1N004	45210-SH3-913	EH-008R	46010-01J00	MN-078
45022-SH3-G01	C1N004	45210-SH3-930	EH-034R	46010-01L00	MN-027
45022-SH3-G02	C1N004	45210-SH3-931	EH-034R	46010-02J00	MN-003
45022-SH3-G03	C1N004	45210-SH3-932	EH-034R	46010-02W10	MN-026
45022-SH3-G10	C1N036	45210-SK7-003	EH-013R	46010-03A00	MN-016
45022-SH3-G11	C1N036	45210-SM2-023	EH-003R	46010-03R05	MN-004
45022-SH3-G50	C1N004	45210-SR3-G01	EH-007R	46010-04B00	MN-005
45022-SH3-N30	C1N013	45210-SR3-N32	EH-014R	46010-04B05	MN-005
45022-SL0-G00	C1N018	45210-SR3-V11	EH-035R	46010-04B15	MN-025
45022-SL0-G01	C1N018	45210-SR3-V12	EH-035R	46010-04P00	MN-074
45022-SL0-G02	C1N018	45210-SR3-V13	EH-035R	46010-04P20	MN-006
45022-SM2-000	C1N014	45230-657-672	EH-020L	46010-06F00	MN-074
45022-SM2-010	C1N014	45230-659-013	EH-020L	46010-06F20	MN-008
45022-SM4-A00	C1N034	45230-659-023	EH-020L	46010-07P01	46010-07P01
45022-SM5-305	C1N018	45230-659-033	EH-020L	46010-07P02	46010-07P02
45022-SM5-A00	C1N018	45230-SA0-681	EH-019L	46010-07P03	46010-07P03
45022-SN7-G41	C1N023	45230-SA0-682	EH-019L	46010-07P10	46010-07P10
45022-SN7-G42	C1N023	45230-SA0-772	EH-018L	46010-08W10	MN-024
45022-SN7-G50	C1N018	45230-SA5-003	EH-002L	46010-09G00	MN-083
45022-SR3-G00	C1N020	45230-SA5-013	EH-002L	46010-0M801	MN-114
45022-SR3-G01	C1N020	45230-SA5-023	EH-002L	46010-0M821	MN-114
45022-SR3-V01	C1N016	45230-SA5-033	EH-002L	460100N620	MN-139
45022-SR3-V10	C1N016	45230-SA5-602	EH-023L	46010-12T10	MN-095
45022-SR3-V11	C1N016	45230-SA5-N50	EH-023L	46010-13W10	MN-027
45022-SR3-V12	C1N016	45230-SA6-602	EH-033L	4601015G01	MN-022
45022-SS0-G00	C1N018	45230-SA7-601	EH-015L	46010-16C10	MN-129
45022-SS0-G01	C1N018	45230-SB0-675	EH-026L	46010-16R00	MN-070
45022-SS0-G02	C1N018	45230-SB6-602	EH-011L	46010-16R05	MN-070
45022-SS0-G10	C1N023	45230-SD2-A13	EH-025L	46010-16R15	MN-070
45022-SV4-000	C1N014	45230-SD4-670	EH-013L	46010-18C01	MN-112
45210-657-672	EH-020R	45230-SD4-671	EH-013L	46010-1M320	MN-109
45210-659-013	EH-020R	45230-SD4-672	EH-013L	46010-1N500	MN-110
45210-659-023	EH-020R	45230-SD4-673	EH-013L	46010-22F00	MN-072
45210-659-033	EH-020R	45230-SD4-674	EH-013L	46010-22F01	MN-072
45210-SA0-681	EH-019R	45230-SD4-675	EH-013L	46010-22F21	MN-017
45210-SA0-682	EH-019R	45230-SE0-A13	EH-025L	46010-23P08	MN-093
45210-SA0-772	EH-018R	45230-SG0-G13	EH-030L	4601024E00	MN-136
45210-SA5-003	EH-002R	45230-SG0-J01	EH-031LR	4601024E01	MN-136
45210-SA5-013	EH-002R	45230-SH3-023	EH-006L	46010-25G00	MN-077
45210-SA5-023	EH-002R	45230-SH3-913	EH-008L	460102F001	MN-131
45210-SA5-033	EH-002R	45230-SH3-930	EH-034L	46010-2N320	MN-119
45210-SA5-602	EH-023R	45230-SH3-931	EH-034L	46010-30P01	MN-097
45210-SA5-N50	EH-023R	45230-SH3-932	EH-034L	46010-30R20	MN-094
45210-SA6-602	EH-033R	45230-SK7-003	EH-013L	46010-30W00	MN-019
45210-SA6-N50	EH-033R	45230-SM2-023	EH-003L	46010310	MN-136
45210-SA7-601	EH-015R	45230-SR3-G01	EH-007L	4601031E01	MN-136
45210-SB0-675	EH-026R	45230-SR3-N32	EH-014L	46010-31G00	MN-084
45210-SB6-602	EH-011R	45230-SR3-V11	EH-035L	46010-31W00	MN-019
45210-SD2-A13	EH-025R	45230-SR3-V12	EH-035L	46010-32G00	MN-084
45210-SD4-670	EH-013R	45230-SR3-V13	EH-035L	46010-34A05	MN-021
45210-SD4-671	EH-013R	45230-SR3-V14	EH-035L	46010-3L120	MN-113
45210-SD4-672	EH-013R	45310-679-003	AH-011RFA	46010-3S410	MN-121
45210-SD4-673	EH-013R	45330-679-003	AH-011LFA	46010-3S460	MN-124

# CROSS REFERENCE LIST

## OE N<sup>R</sup> TO AISIN N<sup>R</sup>

OE N <sup>R</sup>	AISIN N <sup>R</sup>	OE N <sup>R</sup>	AISIN N <sup>R</sup>	OE N <sup>R</sup>	AISIN N <sup>R</sup>
46010-41F10	MN-092	46010-D6001	MN-088	4605A389	A2N012
46010-42G10	MN-111	46010-E8702	MN-029	46100-634-672	MH-025
4601045G00	MN-135	46010-F5600	MN-013	46100-692-013	MH-005
46010-48W00	MN-027	46010-G1500	MN-030	46100-692-601	MH-005
46010-49L01	MN-022	46010-G2700	MN-031	46100-692-602	MH-005
46010-4U220	MN-906	46010-G2800	MN-101	46100S04A02	MH-041
46010-54W20	MN-023	46010-G3300	MN-032	46100-S04-A11	MH-032
4601058Y02	MN-132	46010-G4001	MN-075	46100S04A12	MH-032
46010-59A00	MN-106	46010-G4200	MN-034	46100-S04-A13	MH-032
46010-59A01	MN-103	46010-G5101	46010-G5101	46100S04AO1	MH-041
46010-59A11	MN-103	46010-G6310	46010-G6310	46100-S04-L51	MH-027
460105M302	MN-137	46010-G9825	MN-120	46100-S04-L52	MH-027
460105M303	MN-137	46010-H3101	MN-115	46100S04L53	MH-027
46010-60Y71	MN-091	46010-H6100	MN-037	46100-S04-L71	MH-036
46010-63C00	MN-104	46010-J0117	MN-014	46100-S04-N71	MH-037
46010-63C10	MN-104	46010-M1010	MN-039	46100-S10-023	MH-033
46010-63C20	MN-104	46010-M3802	MN-040	46100-S10-951	MH-035
46010-64J65	MN-099	46010-M3810	MN-041	46100S30A01	MH-042
46010-64J68	MN-128	46010-M3911	MN-042	46100-S5D-L01	MH-034
4601064J75	MN-099	46010-M7500	MN-015	46100-SA5-003	MH-001
46010-65A00	MN-108	46010-M7900	MN-043	46100-SA5-013	MH-001
46010-65C00	MN-118	46010-P5600	MN-045	46100-SA5-023	MH-001
46010-65C10	MN-118	46010-P6500	MN-045	46100-SA5-033	MH-001
46010-65C20	MN-089	46010-P9100	MN-046	46100-SA5-601	MH-001
46010-65C70	MN-089	46010-R5901	MN-047	46100-SA5-602	MH-001
46010-65Y63	MN-090	46010-R5911	MN-048	46100-SA5-603	MH-001
4601065Y73	MN-090	46010-R9000	MN-050	46100-SA5-621	MH-001
46010-67A00	MN-107	46010-R9500	MN-049	46100-SA5-622	MH-001
4601069C21	MN-139	46010-R9560	MN-050	46100-SA5-623	MH-001
46010-70J26	MN-902	46010-S0100	MN-051	46100-SA5-631	MH-001
46010-70J28	MN-902	46010-S6700	MN-052	46100-SA5-632	MH-001
46010-70J85	MN-901	46010-T5800	MN-102	46100-SA5-633	MH-001
46010-72Y04	MN-105	46010-T6400	MN-095	46100-SA5-953	MH-006
46010-72Y24	MN-105	46010-T6410	MN-087	46100-SA5-954	MH-006
46010-73R00	MN-098	46010-T6411	MN-087	46100-SA7-601	MH-007
46010-7F025	MN-122	46010-U0507	MN-053	46100-SA7-602	MH-007
46010-81N01	MN-100	46010-U0508	MN-053	46100-SA7-603	MH-007
46010-88E21	MN-073	46010-U7002	MN-054	46100-SA7-953	MH-007
46010-88G000	MN-096	46010-U7003	MN-054	46100-SAA-G51	MH-040
46010-99B86	MN-126	46010-U9400	MN-055	46100-SB0-602	MH-006
460109C103	MN-134	46010-V0100	MN-056	46100-SB0-632	MH-006
46010-B5012	MN-007	46010-V0300	46010-V0300	46100-SD2-A01	MH-009
46010-B5015	MN-007	46010-V7800	MN-060	46100-SD4-801	MH-028
46010-B5025	MN-009	46010-VB000	MN-123	46100-SD4-802	MH-028
46010-C6000	MN-027	46010-VK103	MN-125	46100-SD4-A51	MH-029
46010-C6001	MN-079	46010-W0500	MN-061	46100-SD4-A52	MH-029
46010-C6101	MN-023	46010-W2200	MN-013	46100-SD4-A53	MH-029
46010-C7001	MN-019	46010-W2400	MN-063	46100-SE0-003	MH-002
46010-C7700	MN-011	46010-W2600	MN-064	46100-SE0-013	MH-002
46010C8100	MN-012	46010-W2601	MN-065	46100-SE0-305	MH-002
46010-C8200	MN-082	46010-W2602	MN-013	46100-SE0-801	MH-017
46010-C8201	MN-082	46010-W5600	MN-066	46100-SE0-802	MH-017
46010-C8300	MN-081	46010-Y0101	MN-067	46100-SE0-803	MH-017
46010-C8301	MN-081	46010-Y9507	MN-903	46100-SE0-804	MH-017
46010-C8500	MN-080	46010-Y9625	MN-127	46100-SE0-805	MH-017
46010-C8501	MN-080	46012SN7G50	LH-001	46100-SE0-901	MH-002
46010-D0100	MN-028	46012SN7G51	LH-001	46100-SE0-903	MH-009
46010-D1200	MN-086	460140-0X825	MN-905	46100-SE0-904	MH-009
46010-D2800	MN-071	4605A336	D2N049	46100-SE0-951	MH-019

# CROSS REFERENCE LIST

## OE N<sup>R</sup> TO AISIN N<sup>R</sup>

OE N <sup>R</sup>	AISIN N <sup>R</sup>	OE N <sup>R</sup>	AISIN N <sup>R</sup>	OE N <sup>R</sup>	AISIN N <sup>R</sup>
46100-SE0-952	MH-019	46100SP1003	MH-023	47201-12061	MT-049
46100-SE0-G01	MH-002	46100-SR3-003	MH-003	47201-12090	BMT-065
46100-SE0-G02	MH-002	46100-SR3-013	MH-003	47201-12091	BMT-065
46100-SE3-023	MH-022	46100-SR3-831	MH-008	47201-12101	MT-028
46100-SF1-003	MH-023	46100-SR3-832	MH-008	47201-12230	MD-018
46100-SF1-013	MH-023	46100-SR3-833	MH-008	47201-12240	47207-12020
46100-SF1-023	MH-023	46100-SR3-911	MH-004	47201-12250	MD-016
46100-SF1-033	MH-023	46100-SR3-912	MH-004	47201-12260	47207-12020
46100-SF1-953	MH-026	46100-SR3-913	MH-004	47201-12270	BMT-027
46100-SF9-003	MH-015	46100-SS0-A51	MH-030	47201-12280	BMT-074
46100-SF9-013	MH-015	46100-SS0-A52	MH-030	47201-12281	BMT-074
46100-SF9-023	MH-015	46100-SS0-A53	MH-030	47201-12300	MT-050
46100-SF9-801	MH-018	46400S03Z01	LH-006	47201-12301	47201-12301
46100-SF9-802	MH-018	46400S04N11	LH-004	47201-12331	MT-024
46100-SF9-803	MH-018	46400S04N51	LH-006	47201-12350	BMT-263
46100-SG9-802	MH-031	46400S04N61	LH-006	47201-12370	BMT-043
46100SH3013	MH-043	46400SD2A04	LH-002	47201-12400	47201-12400
46100SH3023	MH-043	46400SM4003	LH-007	4720112410	MT-001
46100SH3033	MH-043	46400SR3003	LH-003	47201-12420	MT-001
46100-SH3-932	MH-009	46400SR3911	LH-005	47201-12430	BMT-076
46100-SH3-A02	MH-003	46400ST3ZE010	LE-RO01	47201-12440	47201-12440
46100-SH3-A03	MH-003	46O1002J00	MN-003	47201-12480	47201-12480
46100-SH3-A04	MH-003	46O1059A00	MN-106	47201-12530	BMT-173
46100-SH3-A05	MH-003	47150-30370-71	MW-7401	47201-12550	BMT-002
46100-SH3-A06	MH-003	47200-10330	MT-101	47201-12570	BMT-113
46100-SH3-G11	MH-004	47200-10340	MT-100	47201-12590	BMT-028
46100-SH3-G12	MH-004	47200-12142	MT-026	47201-12600	BMT-086
46100-SH3-G13	MH-004	47200-12153	MT-023	47201-12640	BMT-055
46100-SH3-G14	MH-004	47200-12700	MT-094	47201-12670	BMT-264
46100-SH3-G15	MH-004	47200-35021	BMT-112	47201-12680	BMT-017
46100-SH3-G16	MH-004	47200-4870	MW-4870	47201-12690	MT-084
46100-SH3-G17	MH-004	47200-55054	BMT-260	47201-12710	MT-083
46100-SH3-G51	MH-011	47200-55100	47200-55100	47201-12720	MT-085
46100-SH3-N51	MH-019	47200-55120	BMT-261	47201-12740	BMT-024
46100-SH3-N52	MH-019	47200-60050	BMT-112	47201-12750	BMT-120
46100-SH4-A11	MH-010	47200-7401	MW-7401	47201-12761	BMT-121
46100-SK3-801	MH-013	47200-87520	MD-020	47201-12800	BMT-009
46100-SK3-802	MH-013	47200-87524	MD-022	47201-12820	MT-005
46100-SK3-803	MH-013	47200-87712	MD-015	47201-12830	BMT-009
46100-SK7-003	MH-016	47201-05080	MT-900	47201-12870	BMT-265
46100-SK7-013	MH-016	47201-05111	MT-902	47201-14201	47201-14201
46100-SK7-J01	MH-012	47201-06030	47201-33070	47201-14210	47201-14210
46100-SK7-J02	MH-012	47201-06050	47201-33120	47201-14211	47201-14211
46100-SK7-J03	MH-012	47201-06060	47201-33140	47201-14250	47207-14050
46100SM4033	MH-045	4720109060	MT-203	47201-14360	47201-14360
46100-SM4-A01	MH-020	4720109070	MT-204	47201-14400	MT-032
46100-SM4-A02	MH-020	472010F003	LN-002	47201-14410	47201-14410
46100-SM4-A03	MH-020	47201-0F030	MT-903	47201-14470	BMT-105
46100-SM4-A04	MH-020	472010X825	LN-004	47201-14610	MT-109
46100-SM4-G51	MH-021	47201-10040	47207-10020	47201-14640	MT-042
46100-SM4-G52	MH-021	47201-10050	47207-10020	47201-14730	BMT-106
46100-SM4-G53	MH-021	47201-10080	BMT-172	47201-14760	MT-111
46100-SM4-G54	MH-021	47201-10110	BMT-119	47201-14770	MT-110
46100-SM4-J03	MH-016	47201-10120	47201-10120	47201-16060	47207-16020
46100-SM4-J04	MH-016	47201-10130	47201-16180	47201-16100	MT-029
46100SN7G00	MH-044	47201-10150	MT-011	47201-16140	BMT-047
46100SN7G01	MH-044	47201-10170	MT-104	47201-16180	BMT-062
46100SN7G010M1	MH-044	47201-10180	47201-10180	47201-16190	MT-143
46100SP0A54	MH-046	47201-10210	BMT-262	47201-16210	BMT-082

# CROSS REFERENCE LIST

## OE N<sup>R</sup> TO AISIN N<sup>R</sup>

OE N <sup>R</sup>	AISIN N <sup>R</sup>	OE N <sup>R</sup>	AISIN N <sup>R</sup>	OE N <sup>R</sup>	AISIN N <sup>R</sup>
47201-16260	BMT-122	47201-25140	47201-25140	47201-28360	BMT-099
47201-16350	BMT-123	47201-25150	MT-090	47201-28390	BMT-246
47201-16440	BMT-124	47201-25200	BMT-117	47201-28410	BMT-247
47201-17020	BMT-115	47201-25210	MT-060	47201-28480	BMT-276
47201-17070	47201-17070	47201-26070	47201-26070	47201-28591	BMT-277
47201-17090	47201-17090	47201-26090	47201-26090	47201-28601	BMT-202
47201-17291	BMT-125	47201-26110	47201-26110	47201-2B040	47201-2B040
47201-1A020	BMT-267	47201-26180	BMT-060	47201-2B050	BMT-131
47201-1A050	BMT-098	47201-26220	BMT-096	47201-2B070	MT-137
47201-1A070	MT-147	47201-26270	MT-045	47201-2B080	MT-138
47201-1A080	BMT-126	47201-26271	MT-045	47201-2B090	BMT-132
47201-1A110	MT-105	47201-26290	BMT-070	47201-2B100	47201-2B100
47201-1A120	MT-106	47201-26300	47201-26300	47201-2B110	MT-006
47201-1A150	MT-106	47201-26330	47201-26330	47201-2B130	BMT-133
47201-1A330	BMT-127	47201-26410	47201-26410	47201-2B310	BMT-278
47201-1A340	BMT-187	47201-26430	MT-014	47201-30040	47201-30040
47201-1A360	BMT-243	47201-26450	BMT-007	47201-30060	MT-039
47201-1A370	BMT-269	47201-26470	MT-015	47201-30090	MT-040
47201-1A410	BMT-270	47201-26490	BMT-016	47201-30140	47201-30140
47201-20131	MT-033	47201-26501	MT-054	47201-30170	47201-30170
47201-20300	47207-20070	47201-26510	BMT-033	47201-3020	MS-008
47201-20310	MT-034	47201-26520	BMT-198	47201-30260	47201-30260
47201-20360	47201-20360	47201-26530	BMT-004	47201-30310	MT-052
47201-20390	47201-20390	47201-26540	BMT-129	47201-30440	BMT-026
47201-20430	47201-20430	47201-26550	BMT-274	47201-30450	BMT-249
47201-20450	MT-152	47201-26630	MT-142	47201-30530	BMT-205
47201-20470	MT-007	47201-26640	BMT-275	47201-30580	BMT-279
47201-20480	47201-20480	47201-27020	MT-135	47201-30630	BMT-134
47201-20500	MT-008	47201-27030	MT-134	47201-30640	BMT-135
47201-20550	47201-20550	47201-27040	47201-27040	47201-30741	BMT-280
47201-20730	BMT-088	47201-27060	47201-27060	47201-31250	47201-32150
47201-20810	BMT-049	47201-27080	BMT-111	47201-3136	MS-004
47201-20830	47201-20830	47201-27090	47201-27090	47201-32010	47207-32010
47201-20831	47201-20831	47201-27100	BMT-078	47201-32030	47207-32010
47201-20832	47201-20832	47201-27140	BMT-107	47201-32040	47207-32010
47201-20840	47201-20840	47201-27150	BMT-073	47201-32050	47201-32050
47201-20860	BMT-095	47201-27160	BMT-042	47201-32070	47201-32070
47201-20870	47201-20870	47201-27170	BMT-012	47201-32080	47201-32080
47201-20871	47201-20871	47201-27220	BMT-087	47201-32100	47201-32100
47201-20872	MT-205	47201-27230	BMT-084	47201-32110	47201-32110
47201-20881	47201-20881	47201-27240	47201-27240	47201-32120	47201-32120
47201-22060	MT-035	47201-28040	BMT-118	47201-32140	47201-32140
47201-22290	MT-035	47201-28050	47201-28050	47201-32150	BMT-010
47201-22340	MT-036	47201-28060	BMT-053	47201-32170	47201-32170
47201-22350	47201-22350	47201-28070	47201-28070	47201-32180	MT-131
47201-22380	MT-037	47201-28080	47201-28080	47201-32200	MT-132
47201-22450	BMT-271	47201-28090	BMT-025	47201-32210	BMT-114
47201-22520	MT-126	47201-28120	47201-28120	47201-32220	BMT-058
47201-22550	BMT-032	47201-28130	47201-28130	47201-33030	BMT-006
47201-22590	BMT-080	47201-28160	MT-002	47201-33040	BMT-019
47201-22600	BMT-272	47201-28180	MT-044	47201-33050	47201-33050
47201-22620	BMT-244	47201-28190	BMT-130	47201-33060	47201-33060
47201-25060	BMT-128	47201-28200	MT-113	47201-33070	47201-33070
47201-25070	BMT-059	47201-28210	BMT-099	47201-33080	47201-33080
47201-25080	MT-091	47201-28220	MT-115	47201-33100	BMT-116
47201-25090	47201-25140	47201-28310	BMT-089	47201-33101	BMT-136
47201-25100	MT-090	47201-28330	BMT-063	47201-33110	BMT-021
47201-25120	BMT-059	47201-28340	BMT-015	47201-33120	47201-33120
47201-25130	MT-091	47201-28350	BMT-110	47201-33130	BMT-039

# CROSS REFERENCE LIST

## OE N<sup>R</sup> TO AISIN N<sup>R</sup>

OE N <sup>R</sup>	AISIN N <sup>R</sup>	OE N <sup>R</sup>	AISIN N <sup>R</sup>	OE N <sup>R</sup>	AISIN N <sup>R</sup>
47201-33140	BMT-281	47201-36360	MT-057	47201-48090	BMT-162
47201-33210	BMT-137	47201-36380	BMT-104	47201-50010	BMT-072
47201-33350	BMT-138	47201-36390	BMT-252	47201-50050	BMT-037
47201-33360	BMT-209	47201-36392	BMT-287	47201-50090	BMT-227
47201-33370	BMT-282	47201-36400	BMT-142	47201-50150	BMT-163
47201-33430	BMT-283	47201-36420	BMT-216	47201-50160	BMT-079
47201-33520	BMT-284A	47201-36430	BMT-108	47201-50190	BMT-164
47201-33530	BMT-284M	47201-36432	BMT-254	47201-50200	BMT-165
47201-34010	BMT-081	47201-37030	BMT-288	47201-50230	BMT-166
47201-34031	BMT-139	47201-37060	MT-158	47201-50250	BMT-167
47201-34040	BMT-140	47201-37070	BMT-290	47201-53130	BMT-168
47201-35030	47201-35030	47201-38010	BMT-014	47201-60010	BMT-057
47201-35100	47201-35100	47201-38040	BMT-020	47201-60030	BMT-060
47201-35110	MT-145	47201-38042	BMT-218	47201-60031	BMT-060
47201-35120	BMT-067	47201-3D010	BMT-051	47201-60040	MT-047
47201-35130	47201-35130	47201-3D020	BMT-051	47201-60050	BMT-230
47201-35160	47207-35030	47201-3D030	BMT-143	47201-60100	BMT-040
47201-35310	47201-35310	47201-3D040	BMT-029	47201-60110	MT-140
47201-35340	BMT-091	47201-3D050	BMT-054	47201-60120	BMT-061
47201-35350	47201-35460	47201-3D060	BMT-052	47201-60140	BMT-040
47201-35370	BMT-069	47201-3D140	MT-206	47201-60150	MT-141
47201-35380	MT-018	47201-3D141	BMT-081	47201-60160	BMT-031
47201-35400	MT-074	47201-3D150	BMT-048	47201-60210	BMT-061
47201-35420	MT-075	47201-3D151	BMT-048	47201-60211	MT-080
47201-35450	BMT-091	47201-3D160	BMT-144	47201-60230	MT-077
47201-35460	BMT-092	47201-3D161	BMT-145	47201-60231	MT-079
47201-35470	BMT-013	47201-3D211	BMT-291	47201-60240	47201-60240
47201-35510	BMT-036	47201-3D250	BMT-146	47201-60241	MT-067
47201-35541	BMT-030	47201-3D320	BMT-147	47201-60250	47201-60250
47201-35560	BMT-109	47201-3D340	BMT-221	47201-60251	MT-064
47201-35570	BMT-005	47201-3D350	BMT-101	47201-60260	MT-066
47201-35610	MT-118	47201-3D380	BMT-035	47201-60261	MT-069
47201-35620	47201-3D040	47201-3D390	BMT-292	47201-60270	BMT-232
47201-35640	BMT-212	47201-3D420	BMT-222	47201-60271	MT-063
47201-35650	BMT-050	47201-3d460	BMT-293	47201-60280	MT-076
47201-35670	BMT-285	47201-3D470	BMT-224	47201-60281	MT-078
47201-35680	BMT-064	47201-3D510	BMT-294	47201-60290	BMT-022
47201-35720	BMT-056	47201-42010	BMT-148	47201-60291	BMT-022
47201-35740	MT-144	47201-42020	BMT-149	47201-60310	47201-60310
47201-35750	MT-051	47201-42050	BMT-150	47201-60330	MT-096
47201-35770	BMT-045	47201-42070	BMT-151	47201-60370	MT-099
47201-35780	47201-35780	47201-42080	BMT-152	47201-60380	BMT-257
47201-35790	BMT-075	47201-42090	BMT-153	47201-60400	BMT-044
47201-35830	47201-35830	47201-42091	BMT-154	47201-60420	BMT-034
47201-36070	MT-127	47201-42101	BMT-155	47201-60430	MT-082
47201-36080	BMT-103	47201-42190	BMT-156	47201-60450	MT-081
47201-36091	BMT-215	47201-42200	BMT-157	47201-60460	BMT-044
47201-36140	MT-095	47201-42230	BMT-295	47201-60480	MT-071
47201-36160	MT-056	47201-42240	BMT-225	47201-60490	MT-068
47201-36170	BMT-041	47201-42260	BMT-296	47201-60500	47201-60500
47201-36180	MT-058	47201-42270	BMT-297	47201-60510	MT-073
47201-36190	MT-057	47201-43012	BMT-298	47201-60511	BMT-008
47201-36280	BMT-141	47201-43830-71	MW-2850	47201-60521	47201-60521
47201-36290	BMT-093	47201-44041	BMT-301	47201-60530	BMT-102
47201-36300	BMT-041	47201-44130	BMT-302	47201-60540	BMT-303
47201-36310	MT-061	47201-48020	BMT-158	47201-60550	BMT-068
47201-36320	BMT-286	47201-48030	BMT-159	47201-60551	BMT-046
47201-36340	MT-058	47201-48040	BMT-160	47201-60560	47201-60560
47201-36350	MT-062	47201-48070	BMT-161	47201-60570	BMT-090



# CROSS REFERENCE LIST

## OE N<sup>R</sup> TO AISIN N<sup>R</sup>

OE N <sup>R</sup>	AISIN N <sup>R</sup>	OE N <sup>R</sup>	AISIN N <sup>R</sup>	OE N <sup>R</sup>	AISIN N <sup>R</sup>
47201-60571	BMT-304	47207-10020	47207-10020	47510-39096	47510-35041
47201-60580	47201-60580	47207-12020	BMT-240	47510-39135	47510-36060
47201-60590	MT-156	47207-16020	47207-16020	47510-39165	47510-35060
47201-60600	BMT-234	47207-22090	47207-22090	47510-39185	WCT-154
47201-60610	BMT-235	47207-22110	MT-037	47510-39235	47510-35060
47201-60620	MT-149	47207-22120	MT-038	47510-55043	47510-55043
47201-60650	BMT-236	47207-32010	47207-32010	47510-60030	47510-60060
47201-60660	BMT-258	47207-35010	BMT-023	47510-60041	WCT-157
47201-60670	BMT-305	47207-35030	47207-35030	47510-60080	WCT-158
47201-60680	BMT-170	47207-52021	MT-901	47510-60090	AT-029RFD
47201-60690	BMT-171	47207-60010	BMT-040	47510-60100	AT-024RFB
47201-60700	BMT-237	47207-60020	BMT-085	47510-69015	47510-60060
47201-60720	BMT-238	47210-10342-71	MW-002	47510-69035	WCT-157
47201-60831	BMT-239	47210-10480-71	MW-1810	47510-69045	47510-60060
47201-87102-000	MD-012	47210-10660-71	MW-1843	47510-69055	WCT-158
47201-87113	MD-030	47210-10690-71	MW-1842	47510-69065	AT-029RFD
47201-87207	MD-006	47210-10911-71	47210-10911-71	47510-87204	AD-007RFU
47201-87210	MD-014	47210-13002	MW-1832	47510-87306	AD-019RFA
47201-87211-000	MD-006	47210-13002-71	BMW-002	47510-87308	AD-020RFA
47201-87212	MD-013	47210-13500-71	MW-1839	47510-87601	AD-013RF
47201-87214-000	MD-007	47210-20542-71	MW-1821	47510-87602	AD-013RF
47201-87229-000	MD-035	47210-23321-71	BMW-001	47510-87680	AD-016RF
4720187230000	MD-035	47210-23600-71	BMW-003	47510-87701-000	AD-014RFU
47201-87309	MD-027	47210-3810	MW-3810	47520-19025	47520-12011
47201-87310	MD-025	47220-43630-71	BMW-009	47520-19075	47520-10030
47201-87311	MD-028	47230-40300-71	MW-2840	47520-25030	AT-025RFD
47201-87312	BMD-002	47250-12190-71	BMW-010	47520-26010	WCT-035
47201-87407	BMD-003	47260-43630-71	MW-2810	47520-26020	AT-017RF
47201-87503	MD-021	47505-87210	AD-005R	47520-26030	WCT-032
47201-87504	MD-019	47505-87211	AD-011R	47520-27020	AT-013RFL
47201-87513	MD-023	47505-87213	AD-008	47520-29065	47520-26010
47201-87517-000	MD-004	47506-87210	AD-005LB	47520-29075	AT-013RFL
47201-87603	MD-002	47506-87504	AD-011L	47520-29115	AT-025RFD
47201-87608	MD-002	47506-87701	AD-005L	47520-29135	AT-017RF
47201-87609	MD-024	47510-10150-71	MW-2230	47520-35030	47520-35030
47201-87610	MD-002	47510-19035	47510-12011	47520-36041	WCT-089
47201-87611-000	MD-003	47510-19085	47510-10040	47520-36060	WCT-133
47201-87613-000	MD-003	47510-20043	AT-012RF	47520-36070	WCT-159
47201-87615	MD-031	47510-25040	AT-025RFU	47520-36090	WCT-090
4720187615000	MD-031	47510-26010	47510-26030	47520-36100	WCT-049
47201-87701	MD-010	47510-26030	WCT-037	47520-36180	WCT-059
47201-87708	MD-001	47510-26060	WCT-056	47520-36190	WCT-160
47201-87712-000	MD-005	47510-27020	AT-013RFU	47520-37030	WCT-093
47201-87714-000	MD-008	47510-29035	AT-035RF	47520-39066	47520-35021
47201-87716-000	MD-029	47510-29045	AT-035RF	47520-39105	47520-36060
47201-87721-000	MD-009	47510-29078	AT-012RF	47520-39125	47520-35030
47201-92270-00	MD-033	47510-29085	WCT-158	47520-39145	WCT-159
4720197203000	MD-033	47510-29145	47510-26030	47520-39195	47520-35030
4720197204000	MD-033	47510-29155	AT-013RFU	47520-60010	47520-60010
47201-97209	MD-032	47510-29195	AT-025RFU	47520-60020	AT-029RFU
4720197209000	MD-033	47510-35060	47510-35060	47520-60030	AT-024RFA
47201-97210	MD-033	47510-36060	WCT-084	47520-69015	47520-60010
4720197210000	MD-033	47510-36071	WCT-085	47520-69025	AT-029RFU
4720197227000	MD-033	47510-36080	WCT-154	47520-87204	AD-007RFL
4720197238000	MD-033	47510-36090	WCT-136	47520-87303	AD-019RFB
47201-97507	BMD-009	47510-36091	WCT-086	47520-87304	AD-020RFB
472019C001	LN-001	47510-36100	WCT-057	47520-87680	AD-016R
47201-B2030	BMD-010	47510-36170	WCT-041	47520-87701-000	AD-014RFL
47201-B5030	BMD-011	47510-36180	WCT-155	47530-10110-71	MW-4240

# CROSS REFERENCE LIST

## OE N<sup>R</sup> TO AISIN N<sup>R</sup>

OE N <sup>R</sup>	AISIN N <sup>R</sup>	OE N <sup>R</sup>	AISIN N <sup>R</sup>	OE N <sup>R</sup>	AISIN N <sup>R</sup>
47530-13201-71	BMW-011	47540-29075	AT-013LFL	47550-19135	47550-12060
47530-13300-71	MW-3825	47540-29115	AT-025LFD	47550-19165	WCT-024
47530-19035	47530-12011	47540-29145	AT-018LFA	47550-20120	WCT-001
47530-19085	47530-10040	47540-35030	47540-35030	4755020121	WCT-001
47530-20031	AT-034LF	47540-36041	WCT-099	47550-20130	WCT-012
47530-21400-71	BMW-005	47540-36060	WCT-135	47550-20140	47550-20141
47530-22500-71	MW-3815	47540-36070	WCT-211	47550-20141	WCT-105
47530-22501-71	BMW-006	47540-36090	WCT-138	47550-20150	WCT-014
47530-23300-71	BMW-012	47540-36100	WCT-053	47550-20170	WCT-171
47530-25040	AT-025LFU	47540-36180	WCT-042	4755020180	WCT-014
47530-26030	WCT-040	47540-36190	WCT-167	47550-20190	WCT-071
47530-26060	WCT-031	47540-37030	WCT-102	47550-20211	WCT-070
47530-27020	AT-013LFU	47540-39066	47540-35021	47550-22060	WCT-106
47530-29035	AT-035LF	47540-39105	47540-36060	47550-22090	WCT-067
47530-29045	AT-035LF	47540-39125	47540-35030	47550-22100	WCT-107
47530-29065	AT-034LF	47540-39145	WCT-211	47550-25011	WCT-048
47530-29085	WCT-166	47540-39195	47540-35030	47550-25070	WCT-108
47530-29145	47530-26030	47540-60010	47540-60010	47550-25090	WCT-109
47530-29155	AT-013LFU	47540-60020	AT-029LFU	47550-26070	WCT-172
47530-29195	AT-025LFU	47540-60030	AT-024LFA	47550-26090	WCT-005
47530-31420-71	BMW-004	47540-69015	47540-60010	47550-26100	WCT-019
47530-33201-71	MW-1841	47540-69025	AT-029LFU	47550-26110	WCT-027
47530-35060	47530-35060	47540-87204	AD-007LFL	47550-26130	WCT-047
47530-36060	WCT-134	47540-87303	AD-019LFB	47550-26140	WCT-173
47530-36071	WCT-095	47540-87304	AD-020LFB	47550-27020	WCT-029
47530-36080	WCT-162	47540-87680	AD-016L	47550-27030	WCT-050
47530-36090	WCT-137	47540-87701-000	AD-015LFL	47550-28020	WCT-174
47530-36091	WCT-096	47550-05010	AT-046R	47550-28021	WCT-030
47530-36100	WCT-046	47550-05020	AT-045R	47550-28030	47550-28031
47530-36170	WCT-055	47550-05040	AT-047R	47550-28031	47550-28031
47530-36180	WCT-163	475500D010	AT-049	47550-28060	WCT-175
47530-39096	47530-35041	47550-10042	WCT-017	47550-28070	WCT-111
47530-39135	47530-36060	47550-10080	AT-048R	4755029026	47550-12060
47530-39165	47530-35060	47550-10100	WCT-103	47550-29035	AT-014
47530-39185	WCT-162	47550-11032	WCT-024	47550-29075	47550-14020
47530-39235	47530-35060	4755012020	WCT-010	47550-29085	47550-25011
47530-55043	47530-55043	47550-12030	WCT-010	47550-29105	WCT-010
47530-60031	WCT-165	47550-12050	WCT-010	47550-29106	WCT-010
47530-60070	WCT-166	47550-12060	WCT-006	47550-29115	47550-12060
47530-60080	47530-60080	47550-12070	WCT-024	47550-29175	47550-26100
47530-60090	AT-024LFB	47550-12090	47550-16060	47550-29215	47550-25011
47530-69025	WCT-165	47550-14010	AT-007	47550-29265	47550-26090
47530-69045	WCT-166	47550-14020	WCT-008	47550-29275	47550-26110
47530-69055	47530-60080	47550-16010	WCT-002	47550-29305	47550-35160
47530-87204	AD-007LFU	47550-16060	WCT-022	47550-30090	AT-010
47530-87306	AD-019LFA	47550-16070	WCT-168	47550-30100	WCT-003
47530-87308	AD-020LFA	47550-19035	AT-037R	47550-30120	WCT-013
47530-87601	AD-013LF	47550-19045	WCT-010	47550-30130	WCT-004
47530-87602	AD-013LF	47550-19055	AT-007	47550-30140	AT-051
47530-87680	AD-016LF	47550-19065	WCT-010	47550-32010	47550-20130
47530-87701-000	AD-015LFU	47550-19095	47550-10042	47550-32020	WCT-021
47540-10110-71	MW-3040	47550-19096	47550-10042	47550-32030	47550-32030
47540-19025	47540-12011	47550-19097	47550-10042	47550-33010	WCT-038
47540-19075	47540-10030	47550-19105	47550-16011	47550-33020	WCT-077
47540-25030	AT-025LFD	47550-19106	47550-16011	47550-35151	WCT-028
47540-26010	WCT-044	47550-19115	WCT-024	47550-35160	WCT-033
47540-26030	WCT-052	47550-19116	WCT-024	47550-35170	47550-35190
47540-27020	AT-013LFL	47550-19117	WCT-024	47550-35180	WCT-034
47540-29065	47540-26010	47550-19125	WCT-010	47550-35190	WCT-007



# CROSS REFERENCE LIST

## OE N<sup>R</sup> TO AISIN N<sup>R</sup>

OE N <sup>R</sup>	AISIN N <sup>R</sup>	OE N <sup>R</sup>	AISIN N <sup>R</sup>	OE N <sup>R</sup>	AISIN N <sup>R</sup>
47550-35200	WCT-078	47550-87230	AD-004	4756060031	WCT-196
47550-35210	WCT-068	4755087230000	AD-004	47560-60040	AT-028RD
47550-35270	WCT-079	47550-87304	AD-022RA	47560-60070	AT-027RD
47550-35280	WCT-080	47550-87305	AD-021RA	47560-60080	AT-028RD
47550-36050	47550-36050	47550-87311	AD-022RA	47560-60090	WCT-196
47550-36070	WCT-150	47550-87312	AD-023RA	47560-60100	47560-60100
47550-36080	AT-006	47550-87313	AD-024RA	47560-69035	WCT-196
47550-36100	WCT-176	47550-87314	AD-025RA	47560-69045	47560-60100
47550-36110	WCT-114	47550-87401	WCD-001	47560-69055	WCT-196
47550-36120	WCT-020	47550-87507	AD-017R	47560-69065	47560-60100
47550-36130	WCT-115	47550-87509	AD-012R	47560-69075	47560-60110
47550-36150	WCT-116	4755087509000	AD-012R	47560-87303	AD-021RB
47550-36171	WCT-177	47550-87601	47550-87602	47560-87307	AD-022RB
47550-36200	WCT-080	47550-87602	47550-87602	47560-87308	AD-023RB
47550-36210	WCT-058	47550-87608	WCD-002	47560-87309	AD-024RB
47550-37091	WCT-178	47550-87609	AD-002R	47560-87310	AD-025RB
47550-37101	WCT-179	47550-87611	WCD-003	47560-87507	AD-017L
47550-37112	WCT-180	4755087611000	AD-032R	4756087508000	AD-031L
47550-37120	WCT-181	47550-87612	WCT-004	47560-87509	AD-012L
47550-39065	AT-033	47550-87680	47550-87602	4756087509000	AD-012L
47550-39115	47550-26090	47550-87681	47550-87681	4756087520000	AD-030
47550-39125	47550-35160	47550-87682	47550-87682	47570-05010	AT-046L
47550-39175	47550-30100	47550-87683	AD-028R	47570-05020	AT-045L
47550-39215	47550-30120	47550-87684	AD-002R	47570-05040	AT-047L
47550-39235	47550-36050	47550-87702	AD-003	4757010050	AT-048L
47550-39255	47550-36070	47550-87704	AD-018R	47570-10060	WCT-121
47550-39256	47550-36070	47550-87705	AD-006R	47570-12030	47570-16040
47550-39265	AT-026RRU	4755087705000	AD-006R	47570-16010	WCT-002
47550-39275	47550-30130	47550-87706-000	AD-009R	47570-16040	WCT-026
47550-39285	47550-20130	47550-87707	AD-010R	47570-19015	AT-037L
47550-42010	WCT-039	4755087707000	AD-010R	47570-19035	WCT-002
47550-42020	WCT-081	4755087709000	AD-006R	47570-20030	WCT-002
47550-43090	WCT-183	4755087710000	AD-010R	47570-20031	WCT-002
47550-44010	WCT-184	4755087711000	AD-029R	47570-20040	WCT-009
475505020	AT-045R	47550-B4010	WCT-189	47570-20051	WCT-122
47550-52010	WCT-072	47560-25011	WCT-043	47570-20060	WCT-015
47550-52011	WCT-069	47560-25070	WCT-117	4757020080	WCT-015
47550-55034	AT-003	47560-25090	WCT-118	47570-20101	WCT-075
47550-55081	AT-002	47560-29015	WCT-043	47570-20190	WCT-073
47550-60030	AT-027RU	47560-29075	WCT-043	47570-25011	WCT-061
47550-60040	AT-028RU	47560-36050	47560-36050	47570-25070	WCT-123
47550-60070	AT-027RU	47560-36070	WCT-119	47570-25090	WCT-124
47550-60080	AT-028RU	47560-36080	AT-026RRD	47570-29015	47570-25011
47550-60090	WCT-188	47560-36100	WCT-190	47570-29075	47570-25011
47550-60100	47550-60100	47560-36110	WCT-120	47570-32010	47570-20040
47550-60120	WCT-011	47560-36120	WCT-016	47570-32020	WCT-018
47550-60130	WCT-051	47560-36130	WCT-145	47570-32030	47570-32030
47550-63010	WCT-187	47560-36150	WCT-148	47570-33010	WCT-036
47550-69045	WCT-188	47560-36171	WCT-191	47570-33020	WCT-082
47550-69055	47550-60100	47560-36200	WCT-062	47570-36050	47570-36050
47550-69075	WCT-188	47560-36210	WCT-065	47570-36070	WCT-151
47550-69085	47550-60100	47560-37062	WCT-192	47570-36080	AT-026LRU
47550-69095	47550-60110	47560-37072	WCT-193	47570-36100	WCT-197
47550-69105	AT-036	47560-37082	WCT-194	47570-36110	WCT-127
47550-69115	47550-60130	47560-39085	47560-36050	47570-36120	WCT-023
47550-87222	AD-004	47560-39105	47560-36070	47570-36130	WCT-146
4755087222000	AD-004	47560-39106	47560-36070	47570-36150	WCT-128
47550-87227	AD-027	47560-39115	AT-026RRD	47570-36171	WCT-198
4755087227000	AD-027	47560-60030	AT-027RD	47570-36200	WCT-054

CROSS LIST

# CROSS REFERENCE LIST

## OE N<sup>R</sup> TO AISIN N<sup>R</sup>

OE N <sup>R</sup>	AISIN N <sup>R</sup>	OE N <sup>R</sup>	AISIN N <sup>R</sup>	OE N <sup>R</sup>	AISIN N <sup>R</sup>
47570-36210	WCT-045	47580-36110	WCT-131	47730-14041	ET-061R
47570-37051	WCT-199	47580-36120	WCT-025	47730-14050	ET-001R
47570-37061	WCT-200	47580-36130	WCT-147	47730-14130	ET-064R
47570-37072	WCT-201	47580-36150	WCT-149	47730-14140	ET-002R
47570-37080	WCT-202	47580-36171	WCT-205	47730-14150	ET-051RR
47570-39075	47570-36050	47580-36200	WCT-063	47730-14200	ET-056R
47570-39095	47570-36070	47580-36210	WCT-066	47730-14240	47730-14240
47570-39096	47570-36070	47580-37052	WCT-206	47730-16040	ET-046R
47570-39105	AT-026LRU	47580-37062	WCT-207	47730-16090	ET-068R
47570-39115	47570-20040	47580-37072	WCT-208	47730-17020	ET-074RR
475705020	AT-045L	47580-39075	47580-36050	47730-17050	ET-050RR
47570-52010	WCT-076	47580-39095	47580-36070	47730-17090	47730-17090
47570-52011	WCT-074	47580-39096	47580-36070	47730-17140	47730-17140
47570-60030	AT-027LU	47580-39105	AT-026LRD	47730-17150	A5R017
47570-60040	AT-028LU	47580-60030	AT-027LD	47730-20170	ET-016R
47570-60090	AT-027LU	47580-60040	AT-028LD	47730-20190	ET-003R
47570-60100	AT-028LU	47580-60070	AT-027LD	47730-20201	ET-004R
47570-60110	WCT-203	47580-60080	AT-028LD	47730-20210	ET-005R
47570-60120	47570-60120	47580-60090	WCT-209	47730-20211	ET-005R
47570-60130	47570-60130	47580-60100	47580-60100	47730-20230	ET-052RR
47570-69035	WCT-203	47580-69035	WCT-209	47730-20240	47730-20240
47570-69045	47570-60120	47580-69045	47580-60100	47730-20260	47730-33100
47570-69065	WCT-203	47580-69055	WCT-209	47730-20270	ET-053R
47570-69075	47570-60120	47580-69065	47580-60100	47730-20280	ET-024R
47570-69085	47570-60130	47580-69075	47580-60110	47730-20520	47730-20520
47570-87304	AD-022LA	47580-87303	AD-021LB	47730-20530	ET-078R
47570-87305	AD-021LA	47580-87307	AD-022LB	47730-20600	ET-073R
47570-87311	AD-022LA	47580-87308	AD-023LB	47730-20640	A5R012
47570-87312	AD-023LA	47580-87309	AD-024LB	47730-21030	A5R019
47570-87313	AD-024LA	47580-87310	AD-025LB	47730-22100	ET-023R
47570-87314	AD-025LA	47710-87701	ED-001R	47730-22110	ET-054R
47570-87401	WCD-005	47720-87701	ED-001L	47730-22140	ET-028R
47570-87605	AD-002L	47730-10010	ET-043R	47730-22150	ET-025R
47570-87608	WCD-006	47730-10011	ET-044R	47730-22160	ET-026R
47570-87609	WCD-007	47730-10060	ET-045R	47730-24041	47730-24041
4757087609000	AD-032L	47730-10061	ET-045R	47730-24060	47730-24060
47570-87611	WCT-008	47730-10110	ET-042R	47730-24070	47730-24070
47570-87680	AD-002L	47730-12021	ET-062R	47730-25010	47730-25011
47570-87683	47570-87609	47730-12050	ET-063R	47730-25011	47730-25011
47570-87703	AD-018L	47730-12100	ET-006R	47730-25020	47730-25020
47570-87704	AD-006L	47730-12170	ET-016R	47730-26010	ET-035R
4757087704000	AD-006L	47730-12171	ET-016R	47730-26040	ET-033R
47570-87705	AD-009L	47730-12180	ET-017R	47730-26060	ET-034R
4757087705000	AD-006R	47730-12200	ET-018R	47730-26080	ET-037R
47570-87706	AD-010L	47730-12210	ET-009R	47730-26100	47730-26100
4757087706000	AD-010L	47730-12240	ET-007R	47730-26121	ET-065R
4757087708000	AD-029L	47730-12250	ET-001R	47730-26122	ET-065R
47570-87709	AD-006L	47730-12280	ET-049RR	47730-26130	ET-066R
4757087709000	AD-006L	47730-12290	ET-010R	47730-26131	ET-066R
4757087710000	AD-010L	47730-12320	ET-019R	47730-26132	A5R023
47580-25011	WCT-064	47730-12330	ET-047R	47730-27030	ET-067R
47580-25070	WCT-129	47730-12380	ET-020R	47730-27070	ET-057R
47580-25090	WCT-130	47730-12400	ET-012R	47730-28010	ET-041R
47580-29015	47580-25011	47730-12410	ET-013R	47730-28011	ET-041R
47580-29075	47580-25011	47730-12420	47730-12420	47730-28012	ET-041R
47580-36050	47580-36050	47730-12430	ET-048R	47730-28030PL	ET-059R
47580-36070	WCT-152	47730-12450	ET-071R	47730-28070	ET-060R
47580-36080	AT-026LRD	47730-12451	ET-071R	47730-28080	ET-058R
47580-36100	WCT-204	47730-12490	A5R013	47730-28160	ET-075R

# CROSS REFERENCE LIST

## OE N<sup>R</sup> TO AISIN N<sup>R</sup>

OE N <sup>R</sup>	AISIN N <sup>R</sup>	OE N <sup>R</sup>	AISIN N <sup>R</sup>	OE N <sup>R</sup>	AISIN N <sup>R</sup>
47730-28190	ET-070RR	47730-87605	ED-006R	47750-20280	ET-024L
47730-28270	A5R011	47730-87608	ED-007R	47750-20450	ET-021L
47730-30110	ET-027R	47730-87701	ED-002R	47750-20510	ET-073L
47730-30130	ET-031R	47730-87703	47730-87703	47750-20520	47750-20520
47730-30140	ET-055R	47730-87705	ED-004R	47750-20530	ET-078L
47730-30150	ET-030R	47730-87706	ED-003R	47750-20640	A5L012
47730-30160	ET-029R	47730-87707	ED-008R	47750-21030	A5L019
47730-30230	47730-30233	47730-87708-000	ED-009R	47750-22100	ET-023L
47730-30233	47730-30233	47750-10010	ET-043L	47750-22110	ET-054L
47730-30270	47730-30270	47750-10011	ET-044L	47750-22140	ET-028L
47730-30380	ET-082RR	47750-10060	ET-045L	47750-22150	ET-025L
47730-30430	A5R022	47750-10061	ET-045L	47750-22160	ET-026L
47730-30500	A5R021	47750-10110	ET-042L	47750-24041	47750-24041
47730-32050	47730-33100	47750-12021	ET-062L	47750-24060	47750-24060
47730-32070	47730-32070	47750-12050	ET-063L	47750-24070	47750-24070
47730-32150	47730-33100	47750-12100	ET-006L	47750-25010	47750-25011
47730-33010	47730-33100	47750-12170	ET-016L	47750-25011	47750-25011
47730-33020	47730-33020	47750-12171	ET-016L	47750-25020	47750-25020
47730-33040	47730-33040	47750-12180	ET-017L	47750-26010	ET-035L
47730-33050	47730-33051	47750-12200	ET-018L	47750-26040	ET-033L
47730-33051	47730-33051	47750-12210	ET-009L	47750-26060	ET-034L
47730-33060	47730-33061	47750-12240	ET-007L	47750-26080	ET-037L
47730-33061	47730-33061	47750-12250	ET-001L	47750-26100	47750-26100
47730-33090	47730-33090	47750-12280	ET-049LR	47750-26121	ET-065L
47730-33100	47730-33100	47750-12290	ET-010L	47750-26122	ET-065L
47730-33130	ET-069R	47750-12320	ET-019L	47750-26130	ET-066L
47730-33340	A5R008	47750-12330	ET-047L	47750-26131	ET-066L
47730-34020	47730-34020	47750-12380	ET-020L	47750-26132	A5L023
47730-35010	ET-036R	47750-12400	ET-012L	47750-27030	ET-067L
47730-35070	47730-35070	47750-12410	ET-013L	47750-27070	ET-057L
47730-35080	ET-038R	47750-12420	47750-12420	47750-28010	ET-041L
47730-47050	A5R031	47750-12430	ET-048L	47750-28011	ET-041L
47730-48050	A5R014	47750-12450	ET-071L	47750-28012	ET-041L
47730-50030	47730-50031	47750-12451	ET-071L	47750-28030PL	ET-059L
47730-50031	47730-50031	47750-12490	A5L013	47750-28070	ET-060L
47730-50040	ET-080RR	47750-14041	ET-061L	47750-28080	ET-058L
47730-50063	47730-50063	47750-14130	ET-001L	47750-28160	ET-075L
47730-50080	ET-081RR	47750-14140	ET-064L	47750-28190	ET-070LR
47730-50090	47730-50090	47750-14150	ET-002L	47750-28270	A5L011
47730-50100	ET-079R	47750-14160	ET-051LR	47750-30110	ET-027L
47730-50101	ET-079R	47750-14220	ET-056L	47750-30130	ET-031L
47730-50110	47730-50111	47750-14250	47750-14250	47750-30140	ET-055L
47730-50111	47730-50111	47750-16040	ET-046L	47750-30150	ET-030L
47730-50151	ET-087R	47750-16090	ET-068L	47750-30160	ET-029L
47730-52010	ET-072R	47750-17020	ET-074LR	47750-30230	47750-30233
47730-52020	A5R015	47750-17050	ET-050LR	47750-30233	47750-30233
47730-52040	ET-086RR	47750-17090	47750-17090	47750-30270	47750-30270
47730-52170	A5R018	47750-17100	ET-084LR	47750-30380	ET-082LR
47730-52191	A5R009	47750-17140	47750-17140	47750-30430	A5L022
47730-53040	A5R024	47750-17150	A5L017	47750-30500	A5L021
47730-53060	A5R027	47750-20160	ET-016L	47750-32050	47750-33100
47730-60021	ET-039R	47750-20180	ET-003L	47750-32150	47750-33100
47730-60030	ET-040R	47750-20191	ET-004L	47750-33010	47750-33100
47730-60040	ET-077RR	47750-20200	ET-005L	47750-33020	47750-33020
47730-60060	ET-076R	47750-20201	ET-005L	47750-33040	47750-33040
47730-60061	ET-085R	47750-20220	ET-052LR	47750-33050	47750-33051
47730-60070	ET-088R	47750-20230	47750-20230	47750-33060	47750-33061
47730-87602	ED-005R	47750-20260	47750-33100	47750-33090	47750-33090
47730-87603	ED-006R	47750-20270	ET-053L	47750-33100	47750-33100

# CROSS REFERENCE LIST

## OE N<sup>R</sup> TO AISIN N<sup>R</sup>

OE N <sup>R</sup>	AISIN N <sup>R</sup>	OE N <sup>R</sup>	AISIN N <sup>R</sup>	OE N <sup>R</sup>	AISIN N <sup>R</sup>
47750-33130	ET-069L	51100-62G00	MS-026	52402-85200	AS-010LD
47750-33340	A5L008	51100-65D30	BMS-009	52403-60C00	WCS-003
47750-34020	47750-34020	51100-65D71	BMS-017	52403-73041	AS-017RFD
47750-35010	ET-036L	51100-65D80	MS-032	52403-79240	AS-002R
47750-35070	47750-35070	51100-70A00	51100-70A00	52403-85200	AS-010RU
47750-35080	ET-038L	51100-70A40	BMS-010	52404-60C00	WCS-001
47750-47050	A5L031	51100-73210	MS-002	52404-73041	AS-017LFD
47750-48050	A5L014	51100-73610	MS-015	52404-79240	AS-002L
47750-50030	47750-50031	51100-77E00	MS-028	52404-85200	AS-010LU
47750-50031	47750-50031	51100-78412	MS-027	53400-58040	AS-020L
47750-50040	ET-080LR	51100-78460	MS-009	53400-78410	AS-014
47750-50063	47750-50063	51100-78461	MS-009	53400-80040	AS-020L
47750-50080	ET-081LR	51100-78762	MS-009	53401-56A00	AS-021
47750-50090	47750-50090	51100-78A50	BMS-019	53401-56A01	AS-021
47750-50100	ET-079L	51100-79010	MS-024	53401-56B00	AS-005R
47750-50101	ET-079L	51100-79011	MS-024	53401-56B60	AS-025
47750-50110	47750-50111	51100-79012	MS-024	5340160010	AS-020R
47750-50111	47750-50111	51100-79510	MS-012	53401-60A00	AS-007R
47750-50121	ET-087L	51100-79511	MS-012	5340160A00	AS-007R
47750-52010	ET-072L	51100-79512	MS-012	53401-63B00	AS-022R
47750-52020	A5L015	51100-80010	MS-006	5340165D00	AS-031R
47750-52040	ET-086LR	51100-80011	MS-006	53401-70B11	AS-027R
47750-52170	A5L018	51100-80060	MS-003	53401-70C00	AS-018R
47750-52191	A5L009	51100-80110	MS-006	53401-73040	AS-020R
47750-53040	A5L024	51100-80211	MS-006	53401-79740	AS-019R
47750-53060	A5L027	51100-80212	MS-006	53401-80040	AS-020R
47750-60021	ET-039L	51100-80312	MS-006	53401-80050	AS-009R
47750-60030	ET-040L	5110080610	MS-006	53401-81010	AS-011
47750-60040	ET-077LR	5110080660	MS-003	53401-81011	AS-011
47750-60060	ET-076L	51100-80760	MS-016	53401-81A00	AS-028R
47750-60061	ET-085L	51100-81A01	BMS-020	53401-82030	AS-015
47750-60070	ET-088L	51100-81A51	BMS-021	53401-83040	AS-001R
47750-86605	ED-006L	51100-82120	51100-82120	53401-83310	AS-006R
47750-87602	ED-005L	51100-82170	MS-011	53401-84010	AS-008
47750-87603	ED-006L	51100-83020	MS-007	53401-85200	AS-016R
47750-87608	ED-007L	51100-83070	MS-001	5340185220	AS-029R
47750-87701	ED-002L	51100-83220	MS-017	53401-86040	AS-023
47750-87703	47750-87703	5110083E10	MS-042	53402-56B00	AS-005L
47750-87705	ED-004L	51100-84310	MS-010	53402-56B60	AS-026
47750-87706-00	ED-003L	51100-85220	MS-013	5340258040	AS-020L
47750-87707	ED-008L	51100-85310	MS-005	53402-60A00	AS-007L
47750-87708-000	ED-009L	51100-85311	MS-005	5340260A00	AS-007L
47830-33211	A5R020	51100-85710	MS-014	53402-63B00	AS-022L
47830-87101-000	ED-010RR	51100A70B30-000	MO-001	5340265000	AS-031L
47840-87101-000	ED-010LR	51100A78B40-000	MO-002	53402-70B11	AS-027L
47850-33211	A5L020	51300-60A30	BBS-001	53402-70B12	AS-027L
51000A78B40-000	MO-001	51300-60A60	BBS-005	53402-70C00	AS-018L
51100-54G50	BMS-016	51300-60B20	BBS-003	5340270_00	AS-018L
51100-56B00	MS-023	51300-65D00	BBS-006	53402-79740	AS-019L
51100-56B10	BMS-001	51300-77310	BBS-002	5340280040	AS-020L
51100-56B20	BMS-002	51300-81A50	BBS-007	53402-80050	AS-009L
51100-57B00	BMS-003	51300-82270	BBS-004	53402-81A00	AS-028L
51100-60A20	MS-021	52401-60C00	WCS-002	5340283040	AS-001L
51100-60A30	BMS-004	52401-79240	AS-003R	53402-83300	AS-006L
51100-60A40	MS-020	52401-85200	AS-010RD	53402-85200	AS-016L
51100-60A50	MS-019	52402-60C00	WCS-004	5340285220	AS-029L
51100-60B10	MS-018	52402-73040	AS-017FU	5340163B00	AS-022R
51100-60B20	BMS-007	52402-73041	AS-017FU	5340256B00	AS-005L
51100-61G00	BMS-008	52402-79240	AS-003L	5-47500-229-0	MG-009

# CROSS REFERENCE LIST

## OE N<sup>R</sup> TO AISIN N<sup>R</sup>

OE N <sup>R</sup>	AISIN N <sup>R</sup>	OE N <sup>R</sup>	AISIN N <sup>R</sup>	OE N <sup>R</sup>	AISIN N <sup>R</sup>
5-47500-231-0	MG-009	55200-60810	H1N004	58380-02000	AY-012R
5-47500-270-0	MG-006	55200-60811	H1N004	58380-21010	AY-001
5-47500-270-1	MG-006	55200-60820	H1N004	58380-22000	AY-003R
5-47500-273-0	MG-016	55200-60821	H1N004	58380-24002	AY-001
5-47600-009-3	AG-007RRA	55200-61870	H1N004	58380-24003	AY-001
5-47600-009-4	AG-007RRA	55200-62874	H1N006	58380-25000	AY-015R
5-47600-010-3	AG-007LRA	55200-65D10	H1N001	58380-28000	AY-004R
5-47600-010-4	AG-007LRA	55200-77E00	H1N001	58380-28001	AY-004R
5-47600-010-5	AG-007LRA	55210-50E20	H1N005	583802D000	47570-20040
5-47600-011-3	AG-007RRB	55800-61G50	H1N016	58380-31000	AY-007L
5-47600-011-4	AG-007RRB	55800-61G60	H1N016	58380-31010	AY-007L
5-47600-012-3	AG-007LRB	55800-61G70	H1N016	58380-33000	AY-006R
5-47600-012-4	AG-007LRB	55800-62G60	H1N016	58380-38010	AY-016R
5-47610-013-2	AG-003RF	55800-78G00	C2N022	58380-3A000	AY-017R
5-47610-013-3	AG-003RF	55800-78G01	C2N022	58380-H1030	AY-018R
5-47610-014-2	AG-003LF	55800-80_00	C2N015	58380-M2000	AY-019R
5-47610-014-3	AG-003LF	55800-80J01	C2N015	5842044010	AY-020R
5-47610-014-4	AG-003LF	55810-75F00	H1N020	5842044020	AY-020R
5-47610-062-1	AG-004RF	55810-75F10	H1N020	58420-44210	AY-011R
5-47610-062-2	AG-004RF	55810-76A00	G1N006	58420-4A000	AY-010R
5-47610-063-1	AG-004LF	55810-80J00	H1N041	58420-4A020	AY-014R
5-47610-063-2	AG-004LF	558192	ME-OP01	58510-02000	MY-013
55100-60B10	47710-5050	58120-45001	AY-013	58510-17000	MY-014
55100-70A00	47710-5031	58180-23A00	EY-001L	58510-22000	MY-011
55100-70A01	47710-5031	58180-24A00	EY-001L	58510-22010	MY-015
55100-70A02	47710-5031	58180-28A00	EY-001L	58510-22310	MY-016
55100-80010	47710-5031	58180-29A10	EY-002L	58510-22320	MY-017
55101-56B00	ES-007R	58181-23A00	EY-001R	58510-23300	MY-004
55101-60A02	ES-004R	58181-24A00	EY-001R	58510-24001	MY-001
55101-60B30	ES-002R	58181-28A00	EY-001R	58510-24002	MY-001
55101-60B51	47710-5062	58190-29A10	EY-002R	58510-24003	MY-001
55101-60C30	47710-6010	58190-34A20	EY-003R	58510-25000	MY-018
55101-61B50	47710-5065	58310-29A20	EY-004LR	58510-28100	MY-005
55101-64B10	ES-003R	5832044010	AY-020L	58510-28110	MY-005
55101-64B21	ES-003R	5832044020	AY-020L	58510-28310	MY-002
55101-78461	ES-006R	58320-44210	AY-011L	58510-29010	MY-019
55101-82021	ES-001R	58320-4A000	AY-010L	58510-29310	MY-020
55102-50F03	47720-6022	58320-4A020	AY-014L	58510-29315	MY-021
55102-56B00	ES-007L	58330-02000	AY-012L	58510-2C000	MY-022
55102-60A02	ES-004L	58330-11100	AM-006L	58510-2C500	MY-023
55102-60B10	47720-5050	583302000000000	AM-004	58510-2C800	MY-024
55102-60B30	ES-002L	58330-21010	AY-001	58510-2E500	MY-025
55102-60B51	47720-5062	58330-21300	AM-004	58510-32300	MY-026
55102-60C30	47720-6010	58330-22000	AY-003L	58510-33201	MY-027
55102-61B50	47720-5065	58330-23300	AY-001	58510-33203	MY-027
55102-64B10	ES-003L	58330-24002	AY-001	58510-33300	MY-010
55102-64B21	ES-003L	58330-24003	AY-001	58510-34000	MY-006
55102-78461	ES-006L	58330-25000	AY-015L	58510-34010	MY-006
55102-82021	ES-001L	58330-28000	AY-004L	58510-34030	MY-006
55102-85000	ES-005L	58330-28001	AY-004L	58510-34100	MY-007
55108-82021	47710-5021	583302D000	47550-20130	58510-34110	MY-007
55109-82021	47720-5021	58330-31000	AY-007L	58510-34130	MY-007
55110-70A00	H1N011	58330-31010	AY-007L	58510-38004	MY-029
55110-80000	H1N011	58330-33000	AY-006L	58510-38304	MY-030
55110-80010	H1N011	58330-38010	AY-016L	58510-39300	MY-031
55110-80020	H1N011	58330-3A000	AY-017L	58510-3A000	MY-032
55200-50FA0	H1N006	58330-H1030	AY-018L	58510-3A350	MY-033
55200-56831	H1N007	58330-M2000	AY-019L	58510-M3000	MY-034
55200-56870	H1N007	58340-11100	AM-006R	58510-M3001	MY-034



# CROSS REFERENCE LIST

## OE N<sup>R</sup> TO AISIN N<sup>R</sup>

OE N <sup>R</sup>	AISIN N <sup>R</sup>	OE N <sup>R</sup>	AISIN N <sup>R</sup>	OE N <sup>R</sup>	AISIN N <sup>R</sup>
58510-M3010	MY-035	8239-43-990	MZ-008	8-94233-500-4	AG-002LR
58510-M3011	MY-035	8418-43-400A	MZ-012	8-94233-500-6	AG-002LR
58590-H1001	MY-036	8450-33-980	EZ-009R	8-94233-573-1	MG-001
5-86000975	C2N015	8450-33-990	EZ-009L	8-94249-365-2	MG-017
5-86005148	C2N022	8471-26-610A	AZ-018R	8-94256-308-2	AG-002RR
5-86005149	C2N022	8471-26-710A	AZ-018L	8-94313-437-0	MG-013
5-86009163	C2N022	8531-26-610	AZ-014	8-94313-437-2	MG-013
5-86009575	C2N022	8859-43-990	MZ-034	8-94313-438-2	MG-012
5-86011847	C2N015	8-94100-938-0	LG-001	8-94316-097-0	EG-003R
5-86012604	C2N015	8-94112-625-1	MG-004	8-94316-098-0	EG-003L
5-86014313	C2N015	8-94113-582-2	MG-005	8-94332-949-0	MG-014
5-86014813	C2N015	8-94115-835-0	MG-008	8-94332-950-0	MG-015
5-86015195	C2N015	8-94115-835-1	MG-008	8-94332-951-0	MG-011
5-86017797	C2N022	8-94115-835-3	MG-008	8-94332-952-0	MG-018
5-86017798	C2N022	8-94122-860-2	MZ-035	8-94388-012-0	EG-003R
5-86019520	C2N022	8-94124-777-1	EG-002R	8-94388-013-0	EG-003L
5-86202984	C2N021	8-94124-778-1	EG-002L	8-94388-016-0	EG-004R
58620-5H050	MY-009	8-94128-141-1	AG-008RRA	8-94388-017-0	EG-004L
5-86207073	C2N021	8-94128-141-2	AG-008RRA	8-94408-672-0	MG-015
5-86207204	C2N021	8-94128-141-3	AG-008RRA	8-94438-685-1	EG-004R
59110-43000	MY-008	8-94128-142-1	AG-008RRB	8-94438-686-1	EG-004L
61300-60A60	BBS-005	8-94128-142-2	AG-008RRB	8-94453-388-0	EG-007RR
6250-22085	EF-009R	8-94128-142-3	AG-008RRB	8-94453-389-0	EG-007LR
6250-22095	EF-009L	8-94128-143-1	AG-008LR	8-94472-842-2	AG-002LR
6252-00171	AF-004	8-94128-143-2	AG-008LR	89543-32010	AST-001
6252-00173	AF-004	8-94128-144-1	AG-009RA	89544-36030	AST-002
6252-00180	AF-003	8-94128-144-2	AG-009RA	89545-17030	AST-003
6252-00182	AF-003	8-94128-145-1	AG-009RB	89545-24030	AST-004
6252-00372	AF-005	8-94128-145-2	AG-009RB	89545-25010	AST-005
6272-00481	MF-001	8-94128-146-1	AG-009L	89545-37020	AST-006
69021740	AN-053	8-94128-146-2	AG-009L	89545-42030	AST-007
7251-10521	EF-008R	8-94128-147-3	AG-007RRA	89545-48030	AST-008
7251-10531	EF-008L	8-94128-148-3	AG-007RRB	89545-50040	AST-009
7251-63022	EF-001R	8-94128-149-3	AG-007LRB	89545-50050	AST-010
7251-63032	EF-001L	8-94128-150-2	AG-010RA	89546-17030	AST-011
7251-63140	EF-002R	8-94128-151-2	AG-010RB	89546-24020	AST-012
7251-63150	EF-002L	8-94128-152-0	AG-010L	89546-25010	AST-013
7251-63180	EF-003R	8-94128-162-1	AG-004RF	89546-30060	AST-014
7251-63190	EF-003L	8-94128-162-2	AG-004RF	89546-37020	AST-015
7251-77310	AF-001	8-94128-163-1	AG-004LF	89546-42030	AST-016
7251-77750	AF-002	8-94128-163-2	AG-004LF	89546-48030	AST-017
7251-77751	AF-002	8-94173-233-1	MG-011	89546-50040	AST-018
725177752	AF-002	8-94173-235-1	MG-014	89546-50050	AST-019
7257-21020	MF-006	8-94216-943-0	EG-005R	8957-26-610	AZ-017R
7257-21050	MF-008	8-94216-944-0	EG-005L	8957-26-610A	AZ-017R
7257-21051	MF-008	8-94222-652-2	MG-003	8957-26-610B	AZ-017R
7257-21052	MF-008	8-94222-653-2	MG-002	8957-26-610C	AZ-017R
7257-21053	MF-008	8-94226-853-2	MG-007	8957-26-710C	AZ-017L
7257-21081	MF-002	8-94230-529-1	EG-001R	8-97035266	J2N009
7257-21340	MF-007	8-94230-529-2	EG-001R	8-97038-248-0	MG-019
7257-21590	MF-010	8-94230-530-1	EG-001L	8-97039269	J2N009
7701050906	MN-133	8-94230-530-2	EG-001L	8-97066-602-0	EG-007RR
7701050907	MN-133	8-94230-541-0	AG-001	8-97066-603-0	EG-007LR
7701050908	ME-OP02	8-94230-541-1	AG-001	8-97070080	J2N009
7701050909	ME-OP02	8942305412	AG-001	8-97081-147-0	AG-004LF
78BB2140BA	MY-003	8-94230-541-3	AG-001	8-97081-148-0	AG-004RF
8173-33-990	EZ-020L	8-94230-541-5	AG-001	8-97131749	J2N016
8239-33-980	EZ-020R	8-94233-500-2	AG-002LR	8-97148-431-0	MG-020
8239-43-400	MZ-008	8942335003	AG-002LR	8-97171-710-0	BMG-001

# CROSS REFERENCE LIST

## OE N<sup>R</sup> TO AISIN N<sup>R</sup>

OE N <sup>R</sup>	AISIN N <sup>R</sup>	OE N <sup>R</sup>	AISIN N <sup>R</sup>	OE N <sup>R</sup>	AISIN N <sup>R</sup>
8-97175530	J2N009	97039-269	J2N009	AY060-TY002	A2N081
8-97178-0100	MG-047	9-8851-1807-0	AG-005RRA	AY060-TY003	A2N040
8-97185-016-0	MG-021	A132R001	AM-007	AY060-TY004	A2N080
8-97191015	J2N009	AY060-FJ001	F2N012	AY060-TY005	A2N042
8-97191-722-0	WCG-001	AY060-FJ002	F2N015	AY060-TY006	A2N022
8-97191-723-0	WCG-002	AY060-HN002	C2N022	AY060-TY007	A2N084
8-97191-724-0	WCG-003	AY060-HN003	C2N015	AY060-TY009	A2N076
8-97201-007-0	MG-022	AY060-HN005	C2N021	AY060-TY010	A2N047
8-97206870	J2N009	AY060-HN006	C2N015	AY060-TY011	A2N044
8-97206872	J2N016	AY060-KE102	E2N032	AY060-TY012	A2N058
8-97206873	J2N009	AY060-MA001	E2N033	AY060-TY013	A2N027
8-97208-389-0	WCG-004	AY060-MA006	G2N010	AY060-TY014	A2N057
8-97217816	J2N009	AY060-MA007	E2N029	AY060-TY016	A2N030
8-97224-371-0	MG-024	AY060-MA009	E2N030	AY060-TY017	A2N059
8975-33-980	EZ-023R	AY060-MT002	D2N036	B001-26-610	AZ-005
8975-33-990	EZ-023L	AY060-MT003	D2N037	B001-26-610A	AZ-005
8980-43-400	MZ-028	AY060-MT004	D2N028	B001-33-980C	EZ-021R
90235420	AE-OP01	AY060-MT005	D2N012	B001-33-990C	EZ-021L
90235422	AE-OP02	AY060-MT007	D2N040	B092-26-610	AZ-001
9-47601-633-2	AG-005RRA	AY060-MT008	D2N032	B093-43-400	MZ-040
9-47601-633-3	AG-005RRA	AY060-NS001	B2N057	B093-43-400A	MZ-040
9-47601-633-4	AG-005RRA	AY060-NS002	B2N050	BOYA-26-43Z	E2N029
9-47601-634-0	AG-005LRA	AY060-NS003	B2N053	BOYA-26-43ZA	E2N029
9-47601-634-2	AG-005LRA	AY060-NS005	B2N057	BOYA-26-43ZB	E2N029
9-47601-634-3	AG-005LRA	AY060-NS008	B2N056	BOYA-26-48Z	E2N029
9-47601-634-4	AG-005LRA	AY060-NS009	B2N016	BOYW-33-23Z	E1N016
9-47601-635-0	AG-005RRB	AY060-NS010	B2N022	BOYW-33-23ZA	E1N016
9-47601-635-2	AG-005RRB	AY060-NS011	B2N022	BOYW-33-23ZC	E1N016
9-47601-635-3	AG-005RRB	AY060-NS012	B2N022	BOYW-33-28Z	E1N016
9-47601-635-4	AG-005RRB	AY060-NS013	B2N022	BOYW-33-28ZA	E1N016
9-47601-636-0	AG-005LRB	AY060-NS014	B2N029	B107-26-43Z	E2N032
9-47601-636-2	AG-005LRB	AY060-NS015	B2N022	B107-26-48Z	E2N032
9-47601-636-3	AG-005LRB	AY060-NS017	B2N056	B107-26-980B	EZ-015R
9-47601-636-4	AG-005LRB	AY060-NS018	B2N022	B107-26-980E	EZ-015R
9-47601-652-2	AG-006RRA	AY060-NS019	B2N022	B107-26-980F	EZ-015R
9-47601-652-3	AG-006RRA	AY060-NS020	B2N053	B107-26-990B	EZ-015L
9-47601-652-5	AG-006RRA	AY060-NS021	B2N022	B107-26-990E	EZ-015L
9-47601-653-2	AG-006LRA	AY060-NS022	B2N057	B107-26-990F	EZ-015L
9-47601-653-3	AG-006LRA	AY060-NS023	B2N056	B107-49-280	E2N032
9-47601-653-5	AG-006LRA	AY060-NS024	B2N016	B107-49-480	E2N032
9-47601-654-1	AG-006RRB	AY060-NS025	B2N057	B216-26-610	AZ-009
9-47601-654-2	AG-006RRB	AY060-NS027	B2N056	B2Y0-26-48Z	E2N032
9-47601-654-3	AG-006RRB	AY060-NS028	B2N040	B460-33-61X	EZ-006R
9-47601-655-2	AG-006LRB	AY060-NS029	B2N057	B460-33-71X	EZ-006L
9-47601-655-3	AG-006LRB	AY060-NS031	B2N022	B460-33-980B	EZ-006R
9-47601-655-5	AG-006LRB	AY060-NS032	B2N016	B460-33-990B	EZ-006L
9-47601-725-0	AG-011RF	AY060-NS033	B2N040	B462-33-61X	EZ-017R
9-47601-725-1	AG-011RF	AY060-NS034	B2N057	B462-33-71X	EZ-017L
9-47601-726-1	AG-011LF	AY060-NS035	B2N056	B462-33-980B	EZ-017R
9-47601-730-0	AG-012L	AY060-NS036	B2N056	B462-33-990B	EZ-017L
96245156	MO-003	AY060-NS037	B2N040	B4Y1-26-48Z	E2N032
96245158	MO-015	AY060-NS044	B2N053	B4Y1-26-49Z	G2N010
96312155	AO-002	AY060-NS801	B2N045	B4Y6-33-23Z	E1N014
96316435	MO-004	AY060-NS802	B2N016	B4Y6-33-23ZA	E1N014
96316463	MO-005	AY060-NS803	B2N022	B5Y0-26-43Z	G2N010
96320670	AO-001	AY060-NS806	B2N045	B5Y6-33-23Z	E1N014
96518606	AO-001	AY060-NS901	B2N045	B5Y6-33-28Z	E1N014
96574718	AO-003	AY060-NS904	B2N053	B5Y6-33-28ZA	E1N014
97035-266	J2N009	AY060-SZ001	J2N009	B5Y8-33-23Z	E1N014



# CROSS REFERENCE LIST

## OE N<sup>R</sup> TO AISIN N<sup>R</sup>

OE N <sup>R</sup>	AISIN N <sup>R</sup>	OE N <sup>R</sup>	AISIN N <sup>R</sup>	OE N <sup>R</sup>	AISIN N <sup>R</sup>
B5Y8-33-23ZA	E1N014	BR72-43-400C	MZ-043	DB02-43-400B	MZ-088
B6Y3-26-43Z	E2N032	BR72-43-400D	MZ-043	DBP511111	D1N033
B6Y3-26-43ZA	E2N032	BR74-33-61X	EZ-016R	DBP511116	D2N028
B6Y3-26-48Z	E2N032	BR74-33-71X	EZ-016L	DD06M-N1425	B2N045
B6Y3-26-48ZA	E2N032	BR74-33-98Z	EZ-016R	DDY226710	AZ-036
B6Y8-26-43Z	E2N033	BR74-33-99Z	EZ-016L	E0Y8-26-43Z	G2N010
B6Y8-26-43ZA	E2N033	BR75-33-980A	EZ-016R	E0Y8-26-43ZA	G2N010
B6Y8-26-48Z	E2N033	BR75-33-980B	EZ-016R	E0Y8-26-43ZB	G2N010
B6Y8-33-23Z	E1N016	BR75-33-990A	EZ-016L	E0Y9-26-43Z	G2N010
BA01-43-400A	MZ-003	BR75-33-990B	EZ-016L	E0Y9-26-43ZA	G2N010
BA01-43-400B	MZ-003	BR76-26-980B	EZ-029R	E7GZ2261A	AZ-009
BB62-26-610	AZ-015R	BR76-26-990B	EZ-029L	EA26-26-9800A	EZ-038RR
BB62-26-710	AZ-015L	BRY0-33-28Z	E1N014	EA26-26-98Z	EZ-038RR
BBYP-43-40ZC	MZ-053	BRY4-33-23Z	E1N016	EA26-26-990A	EZ-038LR
BC1D-26-610	AZ-024	BRY4-33-28Z	E1N016	EA26-26-99Z	EZ-038LR
BC1D26610A	AZ-024	BRY5-33-23ZA	E1N016	EC25-33-23ZD	E1N066
BC1D26610B	AZ-024	BRY7-33-23ZA	E1N014	FA07-33-980	EZ-022R
BC2A-43-40ZA	MZ-051	BS145-100	EM-043L	FA07-33-980A	EZ-022R
BCFZ-26-98Z	EZ-035R	BS145-200	EM-043R	FA07-33-990	EZ-022L
BCYC-26-43Z	E2N029	BTYF-26-48Z	E2N029	FA07-33-990A	EZ-022L
BCYF-26-43Z	E2N029	BW32-43-400A	MZ-041	FA18-43-400	MZ-029
BCYF-26-43ZA	E2N029	BWYH-26-43Z	G2N010	FA67-49-280	E2N033
BCYF-26-43ZB	E2N029	BWYH-26-48Z	G2N010	FB02-43-400B	MZ-030
BCYF-26-48Z	E2N029	CBY1-33-23ZA	E1N026	FB02-43-400D	MZ-030
BCYW-33-23Z	E1N014	D001-26-610	WCT-048	FB06-49-280	E2N033
BCYW-33-23ZA	E1N014	D001-26-610A	WCT-048	FB06-49-280A	E2N033
BCYW-33-23ZC	E1N014	D001-26-610B	47550-60100	FB60-43-400	MZ-047
BCZF-26-99Z	EZ-035L	D001266IOC	WCT-048	FB60-43-400A	MZ-047
BF67-43400	MZ-013	D001-33-25Z	AZ-015	FB71-26-28ZA	E2N033
BF67-43-400A	MZ-013	D001-33-28Z	E1N013	FBY1-26-48Z	E2N033
BG1R-43-40Z	MZ-052	D1060-11P88	B1N003	FDY1-26-43Z	E2N033
BG62-33-980A	EZ-005R	D1060-11P91	B1N003	FDY1-26-43ZA	E2N033
BG62-33-980B	EZ-005R	D1060-11P92	B1N003	FDY1-26-48Z	E2N033
BG62-33-990A	EZ-005L	D1060-11P93	B1N003	G030-26-610	AZ-003
BG62-33-990B	EZ-005L	D1060-31E85	B1N003	G030-33-980	EZ-007R
BJ79-43-400	MZ-042	D1060-50Y90	B1N017	G030-33-990	EZ-007L
BJ79-43-400A	MZ-042	D1060-F6494	B1N004	G03226610	AZ-003
BJ80-43-400	MZ-014	D1060-V6794	B1N003	G037-26-610	EZ-024RR
BJ80-43-400A	MZ-014	D1060-V7090	B1N003	G037-26-710	EZ-024LR
BJYD-33-23Z	E1N003	D1060-V7091	B1N011	G0YK-26-43Z	E2N033
BJYD-33-28Z	E1N003	D4060-01P90	B2N016	G0YK-26-43ZA	E2N033
BK64-43-400	MZ-016	D4060-31U92	B2N022	G113-33-980	EZ-008R
BK64-43-400A	MZ-016	D4060-60F25	B2N016	G113-33-980A	EZ-008R
BK95-43-400	MZ-015	D4060-60F90	B2N016	G113-33-990	EZ-008L
BK95-43-400A	MZ-015	D406M-N0985	B2N056	G113-33-990A	EZ-008L
BKYT-26-43Z	E2N043	D406M-N0986	B2N016	G211-33-28Z	E1N035
BKYT-26-43ZB	E2N043	D406M-N0989	B2N022	G225-33-28Z	E1N035
BKYT-26-48Z	E2N043	D406M-N1185	B2N053	G304-26-61X	EZ-037RR
BKYT-26-48ZB	E2N043	D406M-N1425	B2N045	G304-26-71X	EZ-037LR
BL78-26-43Z	E2N032	D406M-N1426	B2N045	G5Y5-26-43Z	E2N027
BL78-26-48Z	E2N032	D406M-S1490	B2N050	G5Y6-26-43ZA	E2N027
BOZA-26-98ZB	EZ-035R	DA01-43-400	MZ-044	G5Y6-26-43ZB	E2N027
BOZA-26-99ZB	EZ-035L	DA01-43-400A	MZ-044	G5Y6-26-43ZC	E2N027
BR70-43-400	MZ-007	DA19-33-28ZA	E1N013	G5Y6-26-48Z	E2N027
BR70-43-400B	MZ-007	DA19-33-980A	EZ-026R	G5Y6-26-48ZA	E2N027
BR70-43-400C	MZ-007	DA19-33-980B	EZ-026R	G5Y6-33-23Z	E1N026
BR70-43-400D	MZ-007	DA19-33-990A	EZ-026L	G5Y6-33-28Z	E1N026
BR72-43-400	MZ-043	DA19-33-990B	EZ-026L	GA02-26-610	AZ-011R
BR72-43-400A	MZ-043	DB0243400A	MZ-088	GA02-26-610A	AZ-011R

# CROSS REFERENCE LIST

## OE N<sup>R</sup> TO AISIN N<sup>R</sup>

OE N <sup>R</sup>	AISIN N <sup>R</sup>	OE N <sup>R</sup>	AISIN N <sup>R</sup>	OE N <sup>R</sup>	AISIN N <sup>R</sup>
GA02-26-710	AZ-011L	GJ21-26-610C	AZ-002	HE21-33-990B	EZ-013L
GA02-26-710A	AZ-011L	GJ2126610D	AZ-002	HE21-43-400	MZ-024
GA02-33-980PL	EZ-019R	GJ21-33-28ZB	E1N035	HE21-43-400A	MZ-024
GA02-33-990B	EZ-019L	GJ25-26-48ZA	E2N036	HE25-43-400	MZ-025
GA02-33-990PL	EZ-019L	GJ25-26-61X	EZ-040RR	HE30-43-400	MZ-027
GA02-43-990	MZ-005	GJ25-26-71X	EZ-040LR	HE30-43-400A	MZ-027
GA2E-26-61XA	EZ-036RR	GJ83-43-400	MZ-006	HF39-26-980	EZ-014R
GA2E-26-71XA	EZ-036LR	GJ83-43-400B	MZ-006	HF39-26-990	EZ-014L
GA2E-26-980C	EZ-034RR	GJ87-26-48Z	E2N036	HF45-43-400	MZ-026
GA2E-26-980E	EZ-034RR	GJ87-26-48ZA	E2N036	JOY1-26-43ZB	E2N028
GA2E-26-990C	EZ-034LR	GJ87-26-980A	EZ-040RR	KJ01-26-610	AK-003
GA2E-26-990E	EZ-034LR	GJ87-26-990A	EZ-040LR	LA0126610	AZ-023R
GA3026610	AZ-003	GJ87-43-400A	MZ-017	LA01-26-710	AZ-023L
GA5R-33-61X	EZ-031R	GJ87-43-400B	MZ-017	LC6226610	AZ-038
GA5R-33-71X	EZ-031L	GJ87-43-400C	MZ-017	LC6226610A	AZ-038
GA5R-33-980A	EZ-033R	GJYA-26-43Z	E2N033	LEY4-26-43Z	E2N048
GA5R-33-990A	EZ-033L	GJYA-26-48Z	E2N033	LEY4-26-43ZA	E2N048
GA5R-43-400C	MZ-048	GJYB-26-43Z	E2N033	LEY4-26-48Z	E2N048
GA5R-43-400D	MZ-048	GJYB-26-48Z	E2N033	LEY4-26-48ZA	E2N048
GA5T4340Z	MZ-056	GK69-43-400	MZ-018	LEY6-26-43Z	E2N048
GA5T4340ZA	MZ-056	GK69-43-40Z	MZ-018	MA134929	AM-002R
GA5V-43-40ZA	MZ-019	GN51-33-28Z	E1N035	MA180750	AM-006R
GA5W-43-400D	MZ-085	GN60-33-23Z	E1N035	MA180751	AM-002R
GA97-43-400	MZ-004	GN60-33-28Z	E1N035	MB 180750	AM-006R
GA97-43-400B	MZ-004	GPYA-33-23ZG	E1N068	MB003805	MM-014
GA99-33-980	EZ-025R	GPYB-26-43Z	E2N067	MB003808	MM-013
GA99-33-990	EZ-025L	GS39-26-23Z	E2N033	MB004040	AM-006L
GAYE-26-43ZA	E2N027	H001-26-610A	EZ-011R	MB004041	AM-002L
GAYE-26-43ZB	E2N027	H001-26-610B	EZ-011R	MB058504	EM-002R
GAYE-26-43ZC	E2N027	H001-26-710A	EZ-011L	MB058505	EM-002L
GAYR-33-23ZA	E1N026	H001-26-710B	EZ-011L	MB058553	AM-004
GAYR-33-23ZB	E1N026	H001-33-610	EZ-010R	MB058726	MM-035
GAYR-33-23ZC	E1N026	H001-33-710	EZ-010L	MB058981	MM-007
GAYR-33-23ZD	E1N026	H029-26-610	AZ-004R	MB060245	AM-014LF
GAYR-33-23ZE	E1N026	H029-26-710	AZ-004L	MB060246	AM-014RF
GAYR-33-28ZB	E1N026	H262-26-980	EZ-014R	MB060570	AM-015LF
GAYR-33-28ZC	E1N026	H262-26-980A	EZ-014R	MB060571	AM-015RF
GAYR-33-28ZD	E1N026	H262-26-990	EZ-014L	MB060580	AM-016LA
GAYV-43-40ZC	MZ-019	H262-26-990A	EZ-014L	MB060581	AM-016LB
GAYW4340ZB	MZ-055	H4302-S04-003	C2N022	MB060582	AM-016RA
GB22-33-980	EZ-007R	H4302-SM4-003	C2N015	MB060583	AM-016RB
GB22-33-990	EZ-007L	H4302-SS1-003	C2N022	MB081589	EM-026LR
GBP-90316-AF	C2N022	H4302-SV4-003	C2N015	MB081590	EM-026RR
GCYD-33-23Z	E1N026	H4302-SZ3-003	C2N021	MB081621	MM-021
GCYD-33-23ZA	E1N026	HA18-43-400	MZ-021	MB081624	MM-018
GEYC-26-43Z	E2N033	HA71-33-980	EZ-012R	MB082191	EM-001L
GEYC-26-43ZA	E2N033	HA71-33-980A	EZ-012R	MB082192	EM-001R
GEYC-26-43ZB	E2N033	HA71-33-990	EZ-012L	MB082490	AM-017
GEYC-26-48Z	E2N033	HA71-33-990A	EZ-012L	MB129431	D1N035
GEYC-26-48ZA	E2N033	HA77-43-400	MZ-020	MB134517	MM-032
GEYC-26-48ZB	E2N033	HB40-43-400A	MZ-022	MB134683	EM-014L
GG29-33-980	EZ-028R	HB40-43-400B	MZ-022	MB134684	EM-014R
GG29-33-990	EZ-028L	HB406051	MY-012	MB134828	AM-002L
GGYB-26-43Z	E2N033	HB88-43-400	MZ-023	MB134829	AM-002R
GGYB-26-48Z	E2N033	HB88-43-400A	MZ-023	MB150652	EM-002L
GGYM-26-43Z	E2N033	HB88-43-400B	MZ-023	MB150653	EM-002R
GJ2126610	AZ-009	HE21-33-980A	EZ-013R	MB150653	EM-002R
GJ21-26-610A	AZ-002	HE21-33-980B	EZ-013R	MB150802	EM-025L
GJ21-26-610B	AZ-002	HE21-33-990A	EZ-013L	MB150803	EM-025R
				MB150954	EM-020L

# CROSS REFERENCE LIST

## OE N<sup>R</sup> TO AISIN N<sup>R</sup>

OE N <sup>R</sup>	AISIN N <sup>R</sup>	OE N <sup>R</sup>	AISIN N <sup>R</sup>	OE N <sup>R</sup>	AISIN N <sup>R</sup>
MB150955	EM-020R	MB366282	MM-023	MB618717	MM-052
MB151004	MM-048	MB366288	D2N028	MB618981	AM-005
MB151021	EM-015L	MB366326	AM-007	MB668899	MM-040
MB151022	EM-015R	MB366960	EM-023L	MB699056	D2N032
MB151050	AM-011L	MB366961	EM-023R	MB699088	D1N033
MB151051	AM-011R	MB377826	D2N028	MB699153	D2N041
MB151150	EM-011L	MB377874	D2N028	MB699154	D2N041
MB151151	EM-011R	MB407061	MM-034	MB699174	D1N035
MB162102	AM-018	MB407578	MM-017	MB699266	D1N035
MB193079	MM-019	MB407579	MM-050	MB699439	MM-057
MB193232	MM-008	MB407659	D2N032	MB699452	D1N034
MB193306	EM-012L	MB407755	MM-030	MB699453	D1N034
MB193307	EM-012R	MB500404	MM-024	MB699460	EM-004L
MB193411	AM-004	MB500405	MM-026	MB699461	EM-004R
MB193499	EM-016L	MB500484	AM-003L	MB699463	D1N014
MB193500	EM-016R	MB500485	AM-003R	MB699464	D1N014
MB193820	EM-039LR	MB500639	MM-010	MB699470	EM-006L
MB193821	EM-039RR	MB500673	MM-038	MB699471	EM-006R
MB238059	MM-036	MB500675	MM-039	MB699473	D1N011
MB238080	MM-004	MB500738	AM-010L	MB699474	D1N011
MB238081	MM-001	MB500739	AM-010R	MB699542	MM-041
MB238247	EM-027L	MB500812	D1N033	MB699574	EM-032L
MB238248	EM-027R	MB500813	D1N033	MB699575	EM-032R
MB238476	MM-022	MB500816	D1N033	MB699670	EM-035LR
MB238502	EM-019L	MB500819	D1N033	MB699671	EM-035RR
MB238503	EM-019R	MB500881	MM-051	MB699681	MM-053
MB238510	AM-003L	MB534019	MM-037	MB699703	D1N035
MB238511	AM-003R	MB534020	MM-011	MB699705	EM-038L
MB238691	MM-064	MB534318	EM-017L	MB699706	EM-038R
MB238692	MM-015	MB534319	EM-017R	MB699720	D2N028
MB238700	MM-003	MB534320	EM-018L	MB699721	D2N041
MB238828	AM-001L	MB534321	EM-018R	MB699722	D2N028
MB238829	AM-001R	MB534322	EM-031L	MB699723	D2N028
MB277127	MF-004	MB534323	EM-031R	MB699830	MM-054
MB277194	EM-013L	MB534394	EM-024L	MB845690	MM-028
MB277195	EM-013R	MB534395	EM-024R	MB845691	MM-066
MB277202	AM-008	MB534480	MM-031	MB857331	EM-042LR
MB277336	MM-046	MB534481	MM-045	MB857332	EM-042RR
MB277337	MM-002	MB534653	D2N032	MB857335	D2N032
MB277425	MM-033	MB534703	MM-029	MB857336	D2N032
MB277615	EM-022L	MB534995	D2N028	MB857390	MM-055
MB277616	EM-022R	MB585761	MM-001	MB857392	MM-042
MB277878	EM-003L	MB587022	MM-027	MB857610	D2N036
MB277879	EM-003R	MB587023	EM-005L	MB857729	D2N028
MB295340	MM-058	MB587024	EM-005R	MB857731	D2N041
MB316144	EM-028LR	MB587025	EM-009L	MB857732	D2N041
MB316145	EM-028RR	MB587026	EM-009R	MB857987	D1N034
MB316242	MM-016	MB587560	MM-044	MB858375	D1N035
MB316247	MM-004	MB587561	MM-063	MB858377	D1N035
MB316249	MM-046	MB587562	MM-062	MB858380	D2N032
MB316365	MM-009	MB587640	BBM-001	MB858400	D1N034
MB316368	MM-043	MB587774	EM-030LR	MB858404	EM-036L
MB316369	MM-001	MB587775	EM-030RR	MB858405	EM-036R
MB316425	EM-029L	MB587793	EM-010L	MB858463	D2N037
MB316426	EM-029R	MB587794	EM-010R	MB858464	EM-037LR
MB316762	MM-049	MB587940	MM-047	MB858465	EM-037RR
MB316779	MM-020	MB587941	MM-006	MB858583	D1N035
MB316897	MM-002	MB618174	MM-012	MB858584	D1N034
MB366139	AM-009	MB618188	AM-013	MB858660	D1N035

# CROSS REFERENCE LIST

## OE N<sup>R</sup> TO AISIN N<sup>R</sup>

OE N <sup>R</sup>	AISIN N <sup>R</sup>	OE N <sup>R</sup>	AISIN N <sup>R</sup>	OE N <sup>R</sup>	AISIN N <sup>R</sup>
MB895072	D1N035	MR162523	D1N033	MZ690171	D2N040
MB895090	D1N034	MR162524	D1N033	MZ690187	D2N049
MB895091	D1N034	MR205078	D1N035	NOY6-26-48Z	E2N030
MB895250	D1N034	MR205144	D2N032	NOY6-26-48ZA	E2N030
MB895303	D2N012	MR205146	EM-034L	NOY8-26-43Z	E2N030
MB895429	BMM-001	MR205256	D1N042	NOY8-26-43ZA	E2N030
MB895963	MM-040	MR205257	D1N042	NA01-26-980	EZ-039RR
MB928002	MM-056	MR205269	D2N037	NA01-26-990	EZ-039LR
MB928003	MM-011	MR205377	D2N040	NA01-43-400	MZ-046
MB928049	D1N034	MR244839	MM-065	NA01-43-400C	MZ-046
MB928067	D2N036	MR249087	MM-069	NA01-43-400D	MZ-046
MB928088	MM-059	MR249641	BBM-002	NAY0-26-43Z	G2N010
MB928259	EM-041LR	MR290240	D1N035	NAY0-26-43ZA	G2N010
MB928260	EM-041RR	MR307246	MM-072	NAY1-26-43Z	G2N010
MB928314	D2N040	MR307250	D1N035	NAY1-26-48Z	G2N010
MB928410	EM-040L	MR307358	MM-060	NAY3-43-40Z	MZ-039
MB928411	EM-040R	MR307415	D2N022	NAY5-26-43Z	E2N030
MB928420	D1N013	MR307779	AM-019	NAY5-26-43ZA	E2N030
MB928422	EM-007L	MR389508	D1N013	NAY5-26-43ZB	E2N030
MB928423	EM-007R	MR389512	D1N013	NAY5-26-48Z	E2N030
MB928424	EM-008L	MR389533	D1N035	NAY9-26-43Z	G2N010
MB928425	EM-008R	MR389546	D1N034	NAY9-26-43ZA	G2N010
MB928461	D1N014	MR389547	D1N042	NAY9-26-48Z	G2N010
MB928463	D1N013	MR389548	D1N034	NCY0-26-48Z	E2N030
MB928816	D1N014	MR389550	D1N042	O00126610A	WCT-048
MB928817	D1N013	MR389561	D2N028	OO000AOO159	AS-030
MB928963	D1N013	MR389565	D2N040	S047-43-400	MZ-045
MB950148	MM-057	MR389566	D2N028	S08326610	AZ-006R
MB950181	AM-012	MR389569	D2N040	S083-26-610A	AZ-006R
MB950188	AM-007	MR389571	D2N037	S083-26-710A	AZ-006L
MB950195	EM-033L	MR389572	D2N037	S083-33-980	EZ-003R
MB950196	EM-033R	MR389573	D2N012	S083-33-980A	EZ-003R
MB950350	D2N032	MR389574	D2N012	S083-33-990	EZ-003L
MB950554	D1N014	MR389575	D2N022	S083-33-990A	EZ-003L
MB950555	D1N013	MR389578	D2N032	S083-49-280	E1N008
MC894597	D1N038	MR389579	D2N032	S083-49-280A	E1N009
MC894598	D1N038	MR389580	D2N032	S085-26-610	AZ-007R
MN116770	D2N040	MR389581	D2N036	S08526610A	AZ-007R
MN116929	D2N049	MR389582	D2N036	S085-26-710	AZ-007L
MR128100	D2N012	MR407141	AM-020	S08526710A	AZ-007L
MR128181	D1N035	MR407422	D1N003	S113-26-610	AZ-031R
MR128312	D1N034	MR475453	D1N021	S113-26-710	AZ-031L
MR128750	D2N028	MR510925	D2N036	S121-33-980	EZ-004R
MR128751	D2N041	MR527868	D1N003	S121-33-990	EZ-004L
MR128799	D1N033	MR569780	D2N032	S152-26-610A	AZ-030R
MR128860	BMM-002	MR955068	D2N049	S152-26-710A	AZ-030L
MR129103	D1N034	MR955086	D2N049	S231-49-280	E1N009
MR129104	D1N034	MT191854	AM-004	S231-49-280A	E1N009
MR129144	MM-071	MZ690009	D2N037	S2YA-33-23Z	E1N009
MR129147	MM-060	MZ690010	D2N032	S2YA-33-28Z	E1N009
MR129431	D1N035	MZ690021	D2N036	SA14-26-610	AZ-020R
MR129432	D1N034	MZ690027	D2N022	SA14-26-610A	AZ-020R
MR129433	D2N032	MZ690027Q	D2N022	SA14-26-710	AZ-020L
MR129434	D2N036	MZ690030	D2N037	SA14-26-710A	AZ-020L
MR129438	D2N032	MZ690031	D2N032	SA39-33-980	EZ-002R
MR129536	D1N035	MZ690050	D2N037	SA39-33-980A	EZ-002R
MR129537	D2N032	MZ690051	D2N032	SA39-33-990	EZ-002L
MR129579	D2N032	MZ690166	D2N032	SA39-33-990A	EZ-002L
MR129910	MM-070	MZ690170	D2N037	SA44-43-400	MZ-002

# CROSS REFERENCE LIST

## OE N<sup>R</sup> TO AISIN N<sup>R</sup>

OE N <sup>R</sup>	AISIN N <sup>R</sup>	OE N <sup>R</sup>	AISIN N <sup>R</sup>	OE N <sup>R</sup>	AISIN N <sup>R</sup>
SA70-43-400	MZ-033	UC86-43-400	MZ-049	B22M26610	AZ-037
SE96-33-28Z	E1N009	UC86-43-400B	MZ-049	MB366326	AM-007
SF04-33-28Z	E1N009	UG52-43-400	MZ-087	MB500484	AM-003L
TA01-33-23Z	E1N038	UH7126610	AZ-034	MB500485	AM-003R
U009-26-610	AZ-025	W023-43-400	MZ-032	MB500738	AM-010L
U009-26-710	AZ-029	W023-43-400A	MZ-032	MB500739	AM-010R
UA01-33-980	EZ-001R	W023-43-400B	MZ-032	MB534019	MM-067
UA01-33-990	EZ-001L	W025-26-410A	AZ-010RF	MB587022	MM-027
UB39-26-610	AZ-022R	W025-26-510A	AZ-010L	MB618188	AM-013
UB39-26-710	AZ-022L	W025-26-610A	AZ-010RR	MB668899	MM-040
UB39-33-980A	EZ-032R	B00126610A	AZ-005	MB699439	MM-057
UB39-33-990A	EZ-032L	B2162661 OA	AZ-009	MB699541	MM-068
UB39-43-400A	MZ-036	B21626610	AZ-009	MB699545	MM-073
UB39-43-400B	MZ-036	B21626610B	AZ-009	MB857390	MM-055
UC86-26-610	AZ-023R	B21H26610	AZ-037		
UC86-26-710	AZ-023L	B21H26610A	AZ-037		



# CROSS REFERENCE LIST

## ABS N<sup>R</sup> TO AISIN N<sup>R</sup>

ABS N <sup>R</sup>	AISIN N <sup>R</sup>	ABS N <sup>R</sup>	AISIN N <sup>R</sup>	ABS N <sup>R</sup>	AISIN N <sup>R</sup>
2504	AN-013	36733	A1N085	37228	A2N069
2510	AM-006R	36734	A2N047	37229	A1N101
2511	AM-006L	36737	C1N018	37231	A1N005
2532	AZ-005	36742	B2N022	37233	A2N040
2543	AN-015	36753	D1N034	37258	A2N099
2544	AN-012	36757	C2N015	37264	A2N010
2553	AZ-011L	36758	C2N021	37284	D2N022
2554	AZ-011R	36761	A1N049	37321	B2N064
2564	AH-001L	36763	D1N035	37330	A2N066
2565	AH-001R	36772	D1N014	37355	A2N104
2735	AZ-035	36777	A1N048	37382	E2N033
2858	AE-FO01	36779	B1N054	37384	D2N049
36167	C1N004	36780	C1N023	37399	A1N096
36168	B1N003	36781	D2N037	37459	A2N111
36179	H1N011	36784	C1N020	37545	A2N130
36460	A1N016	36795	E1N026	37569	E2N048
36462	A1N017	36796	E2N027	37611	F2N016
36510	B1N012	36829	A1N093	41109	ME-OP01
36535	A1N034	36831	C1N016	51005	MH-044
36571	E2N033	36852	H1N007	51151	MM-069
36574	E1N013	36864	D2N040	51504	MN-016
36585	A1N034	36865	D1N014	51510	MN-013
36586	B2N016	36866	A1N053	51519	MZ-012
36603	A1N036	36870	C2N022	51521	MZ-003
36604	A2N075	36873	D2N036	51523	MZ-005
36605	A2N044	36875	A2N012	51537	MM-021
36607	E2N032	36878	F1N011	51538	MM-007
36609	D2N028	36882	A1N023	51936	MN-120
36615	C1N033	36920	A1N055	51943	MN-127
36617	B2N045	36921	A2N059	61213	MN-138
36626	A2N080	36922	A2N058	62875	AN-902R
36636	C2N022	36925	D1N042	62876	AN-902L
36639	C1N013	36927	E2N029	520432	MM-049
36642	E1N008	36929	E1N038	520951	EH-004L
36648	D1N033	36936	A2N027	520952	EH-004R
36657	B1N011	36937	A1N056	525471	ET-009L
36659	A1N038	36956	B2N029	525482	ET-009R
36666	E1N035	36960	H1N016	525661	ES-006L
36669	C1N036	36965	H1N001	525672	ES-006R
36672	E2N036	36972	F1N013	525721	EN-028L
36675	H1N004	37033	A1N097	525732	EN-028R
36680	A1N020	37067	E2N033	36168/1	B1N004
36685	B1N020	37081	B1N062	36175/1	A1N091
36690	D2N032	37084	B1N018	36586/1	B2N016
36691	B1N019	37086	H1N020	36642/1	E1N009
36692	B2N008	37096	H1N006	36660/1	A2N076
36701	A1N083	37134	A1N068	36731 OE	A2N042
36702	A1N050	37135	A1N067	36735 OE	A1N053
36711	A1N043	37136	A2N007	36890 OE	D2N012
36712	C2N015	37163	F1N014	36923 OE	A1N056
36713	A1N041	37164	F2N015	36924 OE	A1N025
36720	F1N010	37169	G1N018	42826X	AE-OP01
36721	F2N012	37186	E1N003	42832X	AE-OP02
36722	C1N034	37200	D1N021	51932X	MN-099
36723	H1N016	37203	D1N003	52874X	AF-004
36724	A1N021	37208	B2N022	52875X	AF-005
36726	E1N014	37222	G1N006	52876X	AF-006
36727	E1N016	37226	A2N004	52909X	AH-019L
36728	B1N017	37227	A2N031	52910X	AH-019R

CROSS LIST

## CROSS REFERENCE LIST

### ABS N<sup>R</sup> TO AISIN N<sup>R</sup>

ABS N <sup>R</sup>	AISIN N <sup>R</sup>	ABS N <sup>R</sup>	AISIN N <sup>R</sup>	ABS N <sup>R</sup>	AISIN N <sup>R</sup>
52912X	AN-054	52970X	AH-015L	61938X	MN-901
52915X	AN-906	52971X	AH-015R	62835X	AN-901L
52916X	AN-053	52978X	AZ-036	62836X	AN-901R



# CROSS REFERENCE LIST

## AKEBONO N<sup>R</sup> TO AISIN N<sup>R</sup>

AKEBONO N <sup>R</sup>	AISIN N <sup>R</sup>	AKEBONO N <sup>R</sup>	AISIN N <sup>R</sup>	AKEBONO N <sup>R</sup>	AISIN N <sup>R</sup>
AN103K	A1N016	AN317K	D1N011	AN438WK	A2N094
AN106WK	B2N016	AN318K	D1N014	AN445K	A1N025
AN107WK	B1N009	AN321WK	A2N044	AN447WK	E1N026
AN111K	C1N004	AN322K	A1N041	AN449K	H1N016
AN113K	A1N034	AN323K	A2N042	AN450WK	B1N062
AN118K	A1N061	AN327WK	B1N017	AN451K	H1N001
AN126K	A2N076	AN330K	A1N043	AN455WK	C1N034
AN127K	B1N003	AN333K	A1N049	AN458WK	A1N029
AN128K	D2N028	AN334K	A1N050	AN462WK	F1N014
AN129K	H1N011	AN336WK	A1N023	AN463WK	F1N013
AN130WK	B1N004	AN337K	A2N012	AN464WK	A2N095
AN133K	E1N008	AN338WK	E1N016	AN465WK	A1N097
AN133WK	E1N009	AN340K	A2N047	AN466WK	E2N030
AN209K	E2N032	AN346WK	B2N022	AN467K	A2N030
AN211WK	C1N033	AN348WK	D2N036	AN468WK	D2N022
AN212WK	B1N011	AN349WK	B2N056	AN469WK	A1N096
AN219K	E2N033	AN353K	A2N080	AN475WK	F2N015
AN222WK	A2N081	AN358WK	C1N018	AN477K	H1N020
AN224WK	D2N032	AN359WK	C2N015	AN484WK	A2N031
AN230WK	C1N013	AN366WK	D2N037	AN486K	D1N021
AN233WK	D1N033	AN369WK	A2N084	AN489WK	A2N099
AN249WK	E1N035	AN373WK	B2N057	AN492WK	C2N015
AN254K	A2N040	AN374K	A1N053	AN493K	D1N003
AN261K	A1N019	AN376WK	C1N016	AN496WK	G1N018
AN262WK	B1N020	AN377WK	C1N020	AN499K	A2N004
AN266WK	B2N050	AN379WK	A1N085	AN50K	A1N017
AN267K	A1N036	AN380WK	D2N040	AN602K	E1N003
AN274WK	C1N013	AN383WK	E1N026	AN603K	A1N065
AN275K	A1N020	AN392WK	B2N026	AN604K	A2N066
AN277WK	B1N018	AN394WK	A1N048	AN618WK	A1N067
AN280WK	B2N045	AN395K	A1N055	AN634WK	A1N068
AN282K	H1N005	AN396K	A2N058	AN635WK	A2N007
AN286WK	B1N019	AN398WK	A2N059	AN638WK	A1N101
AN293WK	A1N083	AN400WK	D2N012	AN639WK	A2N069
AN294WK	A1N078	AN403WK	A2N057	AN645K	E2N043
AN296WK	F1N011	AN408WK	A1N093	AN651W	D2N049
AN297WK	F2N012	AN411WK	C2N022	AN653K	A2N010
AN298WK	E1N014	AN413WK	A1N056	AN654WK	B2N064
AN302WK	B2N053	AN421K	E2N029	AN659K	A2N104
AN303WK	A1N021	AN422WK	B2N016	AN667WK	A1N105
AN305K	H1N006	AN423K	E1N038	AN669WK	B2N040
AN306K	A1N038	AN425K	D1N038	AN688WK	A2N111
AN307K	G2N010	AN432WK	B2N029	AN692WK	F2N016
AN310WK	C2N015	AN433WK	D1N042	AN699W	A2N118
AN312WK	D1N035	AN435WK	A1N028	AN704WK	E2N048
AN313WK	D1N034	AN436WK	A2N027	AN756	A2N159

# CROSS REFERENCE LIST

## ASHIKA N<sup>R</sup> TO AISIN N<sup>R</sup>

ASHIKA N <sup>R</sup>	AISIN N <sup>R</sup>	ASHIKA N <sup>R</sup>	AISIN N <sup>R</sup>	ASHIKA N <sup>R</sup>	AISIN N <sup>R</sup>
50-01-103	B1N012	51-01-123	B2N008	67-01-178	AN-035
50-01-111	B1N004	51-01-124	B2N045	67-01-179	AN-042
50-01-137	B1N011	51-01-127	B2N022	67-01-180	AN-016
50-01-143	B1N019	51-01-128	B2N050	67-01-187	AN-049
50-01-144	B1N020	51-01-154	B2N064	67-01-188	AN-904
50-01-178	B1N018	51-01-196	B2N029	67-01-190	AN-003
50-01-195	B1N004	51-02-203	A2N007	67-01-191	AN-011
50-02-203	A1N068	51-02-204	A2N044	67-01-196	AN-007
50-02-214	A1N049	51-02-206	A2N080	67-01-199	AN-901L
50-02-224	A1N049	51-02-207	A2N076	67-02-209	WCT-189
50-02-232	A1N016	51-02-210	A2N012	67-03-303	AZ-003
50-02-235	A1N034	51-02-211	A2N111	67-03-307	AZ-034
50-02-236	A1N017	51-02-212	A2N042	67-03-312	AZ-005
50-02-237	A1N038	51-02-213	A2N051	67-03-313	AZ-001
50-02-245	A1N041	51-02-218	A2N130	67-03-318	AZ-036
50-02-247	A1N036	51-02-256	A2N031	67-03-325	AK-003
50-02-254	A1N021	51-02-258	A2N069	67-03-352	AZ-019L
50-02-255	A1N023	51-02-262	A2N047	67-03-353	AZ-019R
50-02-259	A1N085	51-02-294	A2N080	67-03-355	AZ-016R
50-02-264	A1N048	51-03-302	E2N033	67-03-356	AZ-011L
50-02-281	A1N067	51-03-303	E2N032	67-03-357	AZ-011R
50-02-292	A1N023	51-03-305	E2N028	67-03-362	AZ-004L
50-02-293	A1N028	51-03-306	E2N036	67-03-363	AZ-004R
50-02-295	A1N056	51-03-307	E2N027	67-03-365	AZ-006R
50-03-311	E1N003	51-03-391	E2N030	67-03-368	AZ-013
50-03-326	E1N009	51-04-404	C2N022	67-03-369	AZ-007R
50-03-331	E1N035	51-04-405	C2N015	67-03-396	AZ-023R
50-03-332	E1N013	51-05-500	D2N028	67-03-397	AZ-023L
50-03-341	E1N014	51-05-504	D2N040	67-03-398	AZ-024
50-03-342	E1N016	51-05-508	D2N049	67-03-399	WCT-048
50-03-399	E1N026	51-05-592	D2N022	67-04-401	AH-002L
50-04-414	C1N004	51-05-594	D2N032	67-04-410	AH-019L
50-04-421	C1N013	51-05-599	D2N037	67-04-435	AH-017
50-04-424	C1N033	51-06-601	G2N010	67-04-452	AH-004
50-04-425	C1N020	51-07-701	F2N012	67-04-453	AH-001L
50-04-426	C1N013	51-07-702	F2N015	67-04-454	AH-001R
50-04-432	C1N018	51-07-703	F2N016	67-04-456	AH-003L
50-04-435	C1N016	65-01-199	AN-901R	67-04-457	AS-028L
50-04-493	C1N023	65-04-400	AH-002R	67-04-459	AH-003L
50-05-505	D1N021	65-04-401	AH-003R	67-05-500	AM-002R
50-05-509	D1N003	65-04-403	AH-003R	67-05-501	AM-002L
50-05-525	D1N014	65-08-815	AS-005R	67-05-502	AM-006R
50-05-527	D1N033	67-01-100	AN-015	67-05-503	AM-006L
50-05-528	D1N014	67-01-106	AN-020	67-05-508	AM-011R
50-05-530	D1N035	67-01-107	AN-002	67-05-509	AM-011L
50-05-585	D1N042	67-01-109	AN-017	67-05-514	AM-019
50-05-590	E1N026	67-01-110	AN-008	67-05-531	AM-004
50-05-599	D1N034	67-01-111	AN-052	67-05-532	AM-004
50-07-705	F1N010	67-01-125	AN-051	67-05-533	AM-007
50-07-711	F1N014	67-01-150	AN-025	67-05-534	AM-003L
50-07-796	F1N013	67-01-161	AN-903	67-05-535	AM-003R
50-08-803	H1N011	67-01-168	AN-029	67-05-536	AM-009
50-08-806	H1N004	67-01-169	AN-012	67-05-537	AM-001R
50-08-813	H1N020	67-01-170	AN-026	67-05-538	AM-001L
50-08-816	H1N016	67-01-171	AN-013	67-05-539	AM-013
50-08-893	H1N001	67-01-172	AN-001	67-05-569	AM-012
50-08-897	H1N007	67-01-173	AN-004	67-05-579	AM-005
51-01-121	B2N016	67-01-175	AN-005	67-05-588	AM-018
51-01-122	B2N016	67-01-176	AN-010	67-05-593	AM-010R

# CROSS REFERENCE LIST

## ASHIKA N<sup>R</sup> TO AISIN N<sup>R</sup>

ASHIKA N <sup>R</sup>	AISIN N <sup>R</sup>	ASHIKA N <sup>R</sup>	AISIN N <sup>R</sup>	ASHIKA N <sup>R</sup>	AISIN N <sup>R</sup>
67-05-594	AM-010L	68-01-158	MN-122	68-05-522	MM-004
67-07-703	AF-009	68-01-159	MN-121	68-05-523	MF-004
67-07-704	AF-005	68-01-184	MN-107	68-05-524	MM-019
67-07-705	AF-010	68-01-185	MN-106	68-05-525	MM-022
67-07-711	AF-006	68-01-186	MN-012	68-05-528	MM-040
67-07-712	AF-010	68-01-187	MN-023	68-05-531	MM-052
67-07-713	AF-009	68-01-188	MN-081	68-05-532	MM-053
67-07-798	AF-008	68-01-191	MN-105	68-05-535	MM-037
67-08-813	AS-021	68-01-197	MN-903	68-05-551	MM-070
67-08-820	AS-007R	68-01-199	MN-003	68-05-589	MM-034
67-08-821	AS-007L	68-02-220	BMT-269	68-05-590	MM-043
67-08-822	AS-005L	68-02-270	BMT-048	68-05-591	MM-002
67-08-824	AS-031R	68-02-297	BMT-131	68-05-592	MM-045
67-08-829	AS-026	68-02-299	BMT-029	68-05-593	MM-062
67-08-830	AS-025	68-03-301	MZ-004	68-05-594	MM-030
67-08-832	AS-022R	68-03-305	MZ-029	68-05-595	MM-040
67-08-837	AS-022L	68-03-314	MZ-012	68-05-597	MM-016
67-08-842	AS-028R	68-03-316	MZ-003	68-05-598	MM-011
67-08-894	AT-050	68-03-320	MZ-005	68-05-599	MM-001
67-H0-007	AY-010L	68-03-329	MZ-013	68-07-702	MF-008
67-H0-008	AY-010R	68-03-332	MZ-039	68-07-703	MF-013
67-H0-011	47550-20130	68-03-334	MZ-015	68-07-704	MF-005
67-H0-014	47570-20040	68-03-335	MZ-017	68-07-705	MF-004
67-H0-021	AY-017L	68-03-384	MZ-036	68-08-801	BMS-010
67-H0-022	AY-017R	68-03-387	MZ-002	68-08-809	BMS-007
67-K0-000	AK-001	68-03-390	MZ-007	68-08-819	MS-032
67-K0-001	AK-002	68-03-391	MZ-048	68-08-893	BMS-001
67-K0-002	AK-004	68-03-392	MZ-019	68-08-896	51100-70A00
67-K0-005	AK-002	68-03-393	MZ-006	68-08-898	MS-031
67-W0-000	AE-OP01	68-03-396	MZ-016	68-08-899	BMS-004
67-W0-001	AE-OP02	68-03-398	MZ-042	68-H0-009	MY-022
67-W0-002	AO-001	68-04-409	MH-001	68-H0-010	MY-023
67-W0-003	AO-002	68-04-410	MH-020	68-H0-014	MY-032
67-W0-006	AO-003	68-04-413	MH-003	68-S0-098	MY-012
68-01-100	MN-015	68-04-415	MH-003	68-W0-003	MO-007
68-01-102	MN-043	68-04-416	MH-003	68-W0-004	MO-010
68-01-106	MN-013	68-04-419	MH-021	68-W0-005	MO-009
68-01-108	MN-047	68-04-435	MH-040	68-W0-008	MO-003
68-01-112	MN-045	68-04-499	MH-008	68-W0-009	MO-004
68-01-114	MN-040	68-05-503	MM-038	68-W0-010	MO-005
68-01-115	MN-067	68-05-505	MM-024	68-W0-011	MO-018
68-01-121	MN-123	68-05-507	MM-026	68-W0-012	MO-006
68-01-122	MN-053	68-05-510	MM-013	68-W0-013	MO-016
68-01-126	MN-126	68-05-514	MM-048	68-W0-015	MO-021
68-01-132	MN-050	68-05-515	MM-036		
68-01-135	MN-022	68-05-516	MM-042		

# CROSS REFERENCE LIST

## ATE N<sup>R</sup> TO AISIN N<sup>R</sup>

ATE N <sup>R</sup>	AISIN N <sup>R</sup>	ATE N <sup>R</sup>	AISIN N <sup>R</sup>	ATE N <sup>R</sup>	AISIN N <sup>R</sup>
03.3217-3512.3	AE-OP01	13.0460-5892.2	A1N049	24.3217-1708.3	AN-904
03.3219-6311.3	AE-OP02	13.0460-5898.2	G1N017	24.3217-1712.3	AO-001
13.0460-5710.2	G1N015	13.0460-5918.2	C1N033	24.3217-1715.3	AZ-035
13.0460-5711.2	C2N021	13.0460-5919.2	C1N004	24.3217-1717.3	AH-017
13.0460-5717.2	B1N018	13.0460-5922.2	C1N013	24.3217-1725.3	AS-022L
13.0460-5743.2	A1N073	13.0460-5929.2	C2N015	24.3217-1726.3	AS-022R
13.0460-5744.2	A2N012	13.0460-5932.2	E1N035	24.3219-1107.3	AE-FO01
13.0460-5745.2	A1N023	13.0460-5933.2	B1N021	24.3219-1121.3	AH-001L
13.0460-5750.2	A1N110	13.0460-5935.2	A1N017	24.3219-1122.3	AH-001R
13.0460-5751.2	B1N018	13.0460-5937.2	B1N004	24.3219-1706.3	AZ-003
13.0460-5802.2	E1N003	13.0460-5938.2	A1N036	24.3219-1709.3	AH-019L
13.0460-5804.2	E2N033	13.0460-5939.2	A1N038	24.3219-1710.3	AH-019R
13.0460-5806.2	E1N009	13.0460-5940.2	D1N033	24.3219-1716.3	AM-004
13.0460-5810.2	A1N068	13.0460-5941.2	B1N017	24.3219-1723.3	AH-003L
13.0460-5811.2	A1N067	13.0460-5943.2	C1N020	24.3219-1724.3	AH-003R
13.0460-5812.2	A2N007	13.0460-5944.2	E1N014	24.3219-1725.3	AZ-024
13.0460-5817.2	A1N065	13.0460-5951.2	A1N048	24.3219-1735.3	AZ-036
13.0460-5818.2	C1N034	13.0460-5952.2	D1N035	24.3219-1736.3	AN-051
13.0460-5820.2	C1N016	13.0460-5953.2	D1N014	24.3219-1743.3	AH-015R
13.0460-5824.2	E2N032	13.0460-5954.2	E1N026	24.3219-1744.3	AT-049
13.0460-5826.2	D2N040	13.0460-5955.2	C1N023	24.3219-1745.3	AM-019
13.0460-5831.2	E1N042	13.0460-5957.2	B1N011	24.3219-1751.3	AO-003
13.0460-5834.2	E1N022	13.0460-5958.2	D1N034	24.3219-1752.3	AM-005
13.0460-5835.2	A2N095	13.0460-5966.2	H1N011	24.3220-1625.3	AN-901L
13.0460-5836.2	H1N020	13.0460-5968.2	A1N085	24.3220-1626.3	AN-901R
13.0460-5838.2	H1N016	13.0460-5969.2	A1N043	24.3220-1703.3	AN-013
13.0460-5841.2	B2N029	13.0460-5970.2	E1N013	24.3220-1705.3	AN-052L
13.0460-5843.2	B2N064	13.0460-5971.2	D2N028	24.3220-1718.3	AN-903
13.0460-5846.2	A1N105	13.0460-5972.2	G2N010	24.3220-1719.3	AO-002
13.0460-5847.2	A2N069	13.0460-5973.2	E2N027	24.3220-1729.3	AN-902L
13.0460-5848.2	A1N008	13.0460-5974.2	E1N016	24.3220-1730.3	AN-902R
13.0460-5849.2	A2N031	13.0460-5976.2	A1N034	24.3222-1717.3	AN-053
13.0460-5850.2	F2N012	13.0460-5978.2	F1N010	24.3223-1706.3	AN-052
13.0460-5851.2	F1N013	13.0460-5979.2	E1N015	24.3223-1709.3	AN-906
13.0460-5852.2	G1N018	13.0460-5980.2	D2N032	24.3344-1719.5	EN-084LR
13.0460-5853.2	D1N003	13.0460-5981.2	D2N037	24.3431-1705.5	EM-036L
13.0460-5854.2	D1N021	13.0460-5982.2	C1N018	24.3431-1706.5	EM-036R
13.0460-5857.2	H1N001	13.0460-5983.2	B2N022	24.3481-1725.5	EN-026L
13.0460-5862.2	A2N047	13.0460-5991.2	F1N008	24.3481-1726.5	EN-026R
13.0460-5865.2	E2N030	13.0460-5992.2	A1N021	24.3511-1711.5	A5L015
13.0460-5877.2	E1N006	13.0460-5995.2	E2N036	24.3511-1712.5	A5R015
13.0460-5878.2	C1N030	13.0460-5998.2	C2N022	24.3541-1705.5	ET-071L
13.0460-5879.2	B1N018	13.0460-7213.2	A1N155	24.3541-1706.5	ET-071R
13.0460-5881.2	B1N003	24.2025-1706.3	MN-138	24.3541-1807.5	EY-001L
13.0460-5884.2	E1N004	24.2122-1718.3	MM-069	24.3541-1808.5	EY-001R
13.0460-5887.2	G1N006	24.2123-1761.3	MN-119	24.3571-1703.5	EZ-031L
13.0460-5889.2	D1N013	24.3215-1107.3	AN-002	24.3571-1704.5	EZ-031R
13.0460-5890.2	D1N042	24.3217-1120.3	AZ-002	24.3571-1737.5	EM-017L
13.0460-5891.2	A1N101	24.3217-1703.3	AZ-009	24.3571-1738.5	EM-017R

# CROSS REFERENCE LIST

## BENDIX N<sup>R</sup> TO AISIN N<sup>R</sup>

BENDIX N <sup>R</sup>	AISIN N <sup>R</sup>	BENDIX N <sup>R</sup>	AISIN N <sup>R</sup>	BENDIX N <sup>R</sup>	AISIN N <sup>R</sup>
131878B	MN-901	214206B	AZ-007L	214583B	AS-028L
132329B	ME-OP01	214207B	AN-020	214584B	AS-028R
132487B	MH-044	214209B	AZ-017R	251020B	AN-901L
132488B	MN-902	214210B	AZ-017L	251021B	AN-901R
132500B	MN-134	214216B	AF-006	251024B	AN-052L
132972B	MN-126	214220B	AM-009	251025B	AN-052R
133000B	MN-122	214221B	AM-007	251052B	AN-902L
133044B	MO-004	214222B	AN-015	251053B	AN-902R
133054B	MN-109	214238B	AH-009	571941B	D2N040
133071B	MN-906	214258B	AS-008	571943B	D2N040
133110B	MO-005	214283B	AH-005L	571977B	C2N022
133122B	MH-041	214284B	AH-005R	572100B	E1N013
133135B	MS-031	214289B	AM-004	572110B	B2N022
211746B	AZ-035	214423B	AS-005R	572129B	B2N008
211748B	AE-FO01	214424B	AS-005L	572134B	C2N022
212170B	AE-OP01	214426B	AS-007L	572135B	C2N022
212171B	AE-OP02	214430B	AS-022R	572136B	C2N022
212216B	AN-904	214431B	AS-022L	572138B	C2N015
212220B	AH-019L	214439B	WCT-004	572140B	A1N021
212221B	AH-019R	214459B	AF-002	572145B	E1N014
212321B	AN-903	214466B	AM-005	572146B	E1N016
212331B	AN-906	214467B	AM-013	572153B	B2N045
212332B	AN-053	214476B	AH-003R	572159B	D2N028
212334B	AH-015L	214477B	AH-003L	572161B	E2N027
212335B	AH-015R	214478B	AH-003R	572162B	E2N032
214067B	AM-003L	214479B	AH-003L	572163B	G2N010
214068B	AM-003R	214480B	AH-003L	572166B	H1N004
214071B	AN-044	214481B	AH-003R	572169B	E2N033
214072B	WCT-048	214485B	AN-017	572178B	A1N017
214076B	AN-002	214490B	AN-008	572182B	A2N075
214077B	AH-008	214504B	AN-001	572186B	D2N032
214078B	AN-035	214529B	AM-019	572188B	A2N081
214085B	AH-004	214536B	AT-048R	572189B	B1N012
214088B	AN-012	214537B	AT-048L	572193B	E2N033
214098B	AM-006R	214538B	WCT-076	572197B	F2N012
214103B	WCT-017	214539B	WCT-072	572200B	D2N037
214107B	AZ-009	214540B	AO-001	572206B	B1N009
214109B	AH-002R	214541B	AY-012L	572214B	A1N034
214110B	AH-002L	214542B	AY-012R	572226B	H1N011
214115B	AH-001L	214543B	AN-051	572234B	B2N050
214124B	WCT-005	214544B	AH-017	572237B	C1N004
214127B	AZ-005	214546B	AT-049	572238B	C1N013
214128B	AZ-003	214547B	WCT-075	572245B	A2N012
214129B	AZ-009	214548B	WCT-070	572247B	H1N007
214144B	AG-001	214549B	AO-002	572253B	A1N023
214150B	AZ-006R	214550B	AO-003	572255B	A1N034
214151B	AZ-006L	214551B	WCD-005	572256B	A1N038
214160B	43300-634-670	214552B	WCD-001	572264B	A2N080
214161B	AM-002L	214557B	AY-003L	572275B	F1N010
214162B	AM-002R	214558B	AY-003R	572281B	D1N033
214174B	AM-003R	214561B	AY-004L	572287B	C1N033
214175B	AM-001L	214562B	AY-004R	572288B	C1N033
214176B	AM-001R	214564B	AH-018	572295B	D1N014
214196B	AN-010	214569B	AN-052	572304B	A1N078
214197B	AZ-016R	214573B	WCT-074	572309B	C1N013
214198B	AZ-016L	214574B	WCT-069	572312B	B1N003
214201B	AN-013	214575B	AT-045L	572313B	B1N003
214202B	AN-017	214576B	AT-045R	572317B	E1N035
214205B	AZ-007R	214579B	AT-047L	572324B	C1N020



# CROSS REFERENCE LIST

## BENDIX N<sup>R</sup> TO AISIN N<sup>R</sup>

BENDIX N <sup>R</sup>	AISIN N <sup>R</sup>	BENDIX N <sup>R</sup>	AISIN N <sup>R</sup>	BENDIX N <sup>R</sup>	AISIN N <sup>R</sup>
572325B	E1N026	692521B	EZ-040LR	692877B	EZ-031R
572327B	A1N043	692522B	EZ-040RR	692878B	EZ-036LR
572331B	E1N008	692523B	EZ-005L	692879B	EZ-036RR
572332B	E1N009	692524B	EZ-005R	692880B	EN-026L
572333B	A1N048	692573B	EN-048L	692881B	EN-026R
572339B	B1N020	692574B	EN-048R	692882B	EH-009L
572340B	C1N016	692583B	EM-003L	692883B	EH-009R
572342B	A1N085	692584B	EM-003R	692890B	EN-076LR
572346B	B1N019	692800B	EZ-006L	692891B	EN-076RR
572349B	C1N034	692801B	EZ-006R	692892B	EM-035LR
572350B	C1N023	692802B	EZ-016L	692893B	EM-035RR
572354B	C1N018	692803B	EZ-016R	692896B	EM-037LR
572357B	A1N053	692804B	EM-010L	692897B	EM-037RR
572361B	B1N011	692805B	EM-010R	692898B	47710-5031
572367B	A1N036	692806B	EM-030LR	692899B	47710-5031
572370B	D1N034	692807B	EM-030RR	692900B	ED-010LR
572373B	B1N011	692808B	EN-006L	692901B	ED-010RR
572375B	D1N011	692809B	EN-006R	692904B	EY-001L
572376B	B2N022	692810B	EH-034L	692905B	EY-001R
572378B	A1N049	692811B	EH-034R	692906B	EZ-039LR
572381B	D1N035	692818B	EH-022L	692907B	EZ-039RR
572393B	C1N018	692819B	EH-022R	692916B	EZ-015L
572398B	B2N029	692820B	EH-004L	692917B	EZ-015R
572399B	H1N016	692821B	EH-004R	692920B	EZ-017L
572404B	A1N067	692822B	EG-007LR	692921B	EZ-017R
572405B	A1N068	692823B	EG-007RR	692985B	EH-007L
572419B	D1N042	692826B	EM-016L	692986B	EH-007R
572420B	H1N001	692827B	EM-016R	692987B	EM-038L
572423B	F1N013	692828B	EM-013L	692988B	EM-038R
572424B	F2N015	692829B	EM-013R	692995B	EM-041LR
572434B	E1N026	692830B	EM-023L	692996B	EM-041RR
572437B	E1N003	692831B	EM-023R	694003B	EM-008L
572448B	B1N018	692832B	EM-028LR	694004B	EM-008R
572450B	A2N007	692834B	EM-017L	694007B	EM-036L
572468B	A1N034	692835B	EM-017R	694008B	EM-036R
572471B	G1N006	692836B	EM-018L	694009B	EN-075L
572488B	A2N031	692838B	EN-052LR	694010B	EN-075R
572490B	E2N033	692839B	EN-052RR	694011B	EN-085LR
572493B	D2N036	692850B	EF-004L	694012B	EN-085RR
572497B	D1N003	692851B	EF-004R	694029B	EZ-038LR
572499B	D1N021	692860B	ET-038L	694030B	EZ-038RR
572501B	B2N064	692861B	ET-038R	694041B	EM-040L
572515B	A1N056	692864B	EZ-029L	694042B	EM-040R
572519B	D2N022	692865B	EZ-029R	694177B	47750-33020
572542B	B1N025	692868B	EN-023L	694178B	47730-33020
572547B	D2N049	692869B	EN-023R	694179B	47750-12420
572566B	F1N014	692870B	EN-068LR	694180B	47730-12420
691681B	EN-080L	692871B	EN-068RR		
691682B	EN-080R	692876B	EZ-031L		

# CROSS REFERENCE LIST

## BOSCH N<sup>R</sup> TO AISIN N<sup>R</sup>

BOSCH N <sup>R</sup>	AISIN N <sup>R</sup>	BOSCH N <sup>R</sup>	AISIN N <sup>R</sup>	BOSCH N <sup>R</sup>	AISIN N <sup>R</sup>
0 204 011 217	AT-049	0 986 424 730	A2N066	0 986 494 090	B2N064
0 204 011 241	AN-052	0 986 424 734	B2N029	0 986 494 154	A2N130
0 204 011 273	AN-905	0 986 424 753	E1N038	0 986 505 403	A2N104
0 204 021 711	MN-137	0 986 424 762	A2N069	0 986 AB2 012	A2N080
0 204 021 760	MN-906	0 986 424 770	F1N014	0 986 AB2 028	A2N012
0 204 102 370	EN-080L	0 986 424 771	C2N021	0 986 AB2 036	A2N047
0 986 424 133	A1N091	0 986 424 782	E2N029	0 986 AB2 041	A2N081
0 986 424 134	A1N023	0 986 424 799	A1N053	0 986 AB2 043	A2N057
0 986 424 143	A2N076	0 986 424 814	D2N049	0 986 AB2 046	A2N058
0 986 424 160	B1N009	0 986 424 817	E2N033	0 986 AB2 054	A2N084
0 986 424 183	A1N085	0 986 460 020	E1N008	0 986 AB2 063	A2N030
0 986 424 225	A1N049	0 986 460 040	A2N080	0 986 AB2 077	A2N010
0 986 424 251	H1N007	0 986 460 080	E2N032	0 986 AB2 082	A2N075
0 986 424 264	A1N043	0 986 460 936	C1N033	0 986 AB2 084	A2N099
0 986 424 266	E2N027	0 986 460 974	E1N016	0 986 AB2 086	A2N066
0 986 424 268	A1N021	0 986 460 978	D1N033	0 986 AB2 089	A2N069
0 986 424 289	C1N023	0 986 460 979	D1N035	0 986 AB2 090	A2N007
0 986 424 295	E2N033	0 986 460 984	F1N010	0 986 AB2 091	A2N104
0 986 424 313	A2N012	0 986 461 006	C2N015	0 986 AB2 099	B2N040
0 986 424 319	A1N050	0 986 461 121	B1N020	0 986 AB2 102	D2N040
0 986 424 323	B2N050	0 986 461 123	A1N048	0 986 AB2 121	A2N042
0 986 424 370	D1N035	0 986 461 124	C1N034	0 986 AB2 126	A2N004
0 986 424 382	A1N036	0 986 461 125	C1N013	0 986 AB2 130	A2N118
0 986 424 383	A1N028	0 986 461 126	C1N020	0 986 AB2 132	A2N111
0 986 424 418	B2N008	0 986 461 131	C2N022	0 986 AB2 138	A2N130
0 986 424 427	D2N040	0 986 461 136	A2N075	0 986 AB2 140	B2N026
0 986 424 464	D2N040	0 986 461 138	E2N036	0 986 AB2 141	B2N029
0 986 424 465	H1N016	0 986 461 139	B1N019	0 986 AB2 158	E2N043
0 986 424 523	D1N034	0 986 461 140	A2N047	0 986 AB2 209	B2N008
0 986 424 534	A1N068	0 986 461 141	E1N014	0 986 AB2 218	B2N045
0 986 424 535	A1N067	0 986 461 142	C1N018	0 986 AB2 221	B2N053
0 986 424 572	D1N042	0 986 461 143	F2N012	0 986 AB2 222	B2N022
0 986 424 573	E1N016	0 986 461 144	B2N022	0 986 AB2 228	B2N057
0 986 424 610	E1N003	0 986 461 145	D2N032	0 986 AB2 230	B2N056
0 986 424 626	H1N020	0 986 461 146	G2N010	0 986 AB2 248	B2N016
0 986 424 630	A2N007	0 986 461 750	H1N004	0 986 AB2 254	B2N056
0 986 424 640	A1N005	0 986 461 759	C1N016	0 986 AB2 308	D2N032
0 986 424 641	A2N004	0 986 461 768	D2N037	0 986 AB2 408	J2N009
0 986 424 650	F2N015	0 986 468 520	A1N017	0 986 AB2 458	E2N033
0 986 424 669	H1N001	0 986 468 701	A1N034	0 986 AB2 462	E2N027
0 986 424 686	D2N036	0 986 469 570	B1N012	0 986 AB2 557	E2N032
0 986 424 692	A1N034	0 986 490 440	C1N004	0 986 AB2 610	F2N015
0 986 424 694	E1N026	0 986 490 990	B1N003	0 986 AB2 663	C2N021
0 986 424 700	F1N013	0 986 491 250	D2N028	0 986 AB2 667	C2N022
0 986 424 709	D1N003	0 986 493 480	B1N011	0 986 AB2 675	C2N015
0 986 424 711	D2N022	0 986 493 550	E1N013	0 986 AB2 771	A2N040
0 986 424 713	D1N021	0 986 493 720	A1N038	0 986 AB4 050	E2N032
0 986 424 715	B1N062	0 986 493 790	E1N035	F 026 000 120	C2N022



# CROSS REFERENCE LIST

## CIFAM N<sup>R</sup> TO AISIN N<sup>R</sup>

CIFAM N <sup>R</sup>	AISIN N <sup>R</sup>	CIFAM N <sup>R</sup>	AISIN N <sup>R</sup>	CIFAM N <sup>R</sup>	AISIN N <sup>R</sup>
101-062	43300-634-670	101-375	WCT-174	101-553	AN-003
101-063	WCT-010	101-376	WCT-003	101-554	AN-005
101-064	WCT-006	101-377	WCT-013	101-556	AN-026
101-091	AZ-013	101-378	WCT-011	101-607	AN-053
101-093	AN-032	101-379	AH-005R	101-622	AD-006L
101-094	AN-048	101-380	AH-008	101-623	AD-006R
101-095	AN-013	101-381	AH-003R	101-624	AN-901L
101-113	AZ-014	101-382	AS-028L	101-625	AN-901R
101-132	AM-004	101-383	AS-009L	101-632	AM-001R
101-133	AM-006L	101-384	AS-009R	101-633	AM-001L
101-134	AM-006R	101-385	AS-007L	101-656	AY-004L
101-170	AS-013	101-386	AS-007R	101-657	AY-004R
101-179	AN-015	101-387	AS-023	101-658	AY-001
101-192	AM-002L	101-388	AZ-009	101-659	AY-001
101-193	AM-002R	101-389	AF-002	101-662	AM-009
101-194	AH-007	101-390	AY-001	101-663	AN-904
101-195	AH-009	101-391	AY-001	101-664	AM-010L
101-197	AZ-005	101-393	AY-001	101-665	AM-010R
101-199	AN-012	101-396	WCT-019	101-666	AN-053
101-200	AN-017	101-446	AM-003R	101-667	AN-906
101-203	AN-020	101-447	AM-003L	101-668	AT-046R
101-204	AN-008	101-461	AH-019R	101-669	AT-046L
101-206	AN-019	101-462	AH-019L	101-670	WCT-015
101-207	AH-005L	101-464	AZ-009	101-671	WCT-014
101-208	AH-005R	101-465	WCT-038	101-678	AN-007
101-209	AH-001L	101-466	WCT-036	101-681	AS-022R
101-210	AH-001R	101-467	AZ-022R	101-682	AS-022L
101-211	AZ-011L	101-468	AZ-022L	101-687	AN-001
101-212	AZ-011R	101-471	AN-004	101-707	AH-015L
101-213	AZ-012	101-472	AN-036	101-708	AH-015R
101-214	AZ-016L	101-473	AM-007	101-738	AS-026
101-215	AZ-016R	101-474	AH-003R	101-739	AS-025
101-216	WCT-024	101-475	AH-003L	101-751	WCT-078
101-217	WCT-017	101-482	AH-012	101-761	AS-001R
101-218	47550-16011	101-485	47550-35160	101-762	AS-001L
101-265	WCT-008	101-486	AN-027	101-763	AT-050
101-266	AZ-003	101-487	AN-029	101-764	AN-903
101-267	47550-20130	101-489	AN-035	101-767	AO-001
101-268	WCT-009	101-490	AG-001	101-769	AM-013
101-269	WCT-001	101-492	AZ-019R	101-776	AS-008
101-270	WCT-002	101-493	AN-039	101-777	AK-001
101-286	AH-006	101-494	AN-010	101-778	AS-027L
101-294	AH-004	101-498	AZ-023R	101-782	AF-009
101-298	AE-OP02	101-499	AZ-023L	101-783	AS-020R
101-300	AE-OP01	101-503	AS-006R	101-784	AS-020L
101-322	AN-002	101-504	47550-35190	101-785	AS-021
101-325	AZ-001	101-506	AS-006L	101-786	AS-014
101-338	AF-001	101-507	AS-015	101-794	AZ-024
101-339	AF-004	101-511	AN-050	101-802	AT-047R
101-340	AF-006	101-514	WCT-048	101-803	AT-047L
101-341	AF-003	101-515	AS-005R	101-804	WCT-072
101-342	AF-005	101-516	AS-005L	101-805	WCT-074
101-356	AY-007L	101-517	AN-037	101-806	AZ-035
101-366	AG-002LR	101-521	AZ-015R	101-807	AT-048L
101-368	AS-029L	101-522	AZ-015L	101-808	WCT-007
101-369	AS-029R	101-529	AN-016	101-816	AH-017
101-372	WCT-005	101-530	AN-038	101-818	AY-012L
101-373	WCT-021	101-532	AN-044	101-819	AY-012R
101-374	WCT-018	101-533	AN-025	101-826	AS-028R

# CROSS REFERENCE LIST

## CIFAM N<sup>R</sup> TO AISIN N<sup>R</sup>

CIFAM N <sup>R</sup>	AISIN N <sup>R</sup>	CIFAM N <sup>R</sup>	AISIN N <sup>R</sup>	CIFAM N <sup>R</sup>	AISIN N <sup>R</sup>
101-829	AZ-036	202-346	MY-013	822-226-0	D2N028
101-843	AO-002	202-348	MM-069	822-232-0	E1N009
101-844	WCT-070	202-349	MY-014	822-232-1	E1N009
101-845	WCT-075	202-396	MS-042	822-247-0	C1N004
101-846	AN-051	202-414	MN-138	822-247-1	C1N013
101-853	AM-019	202-497	MH-041	822-248-0	H1N016
101-863	AH-018	202-498	MH-032	822-249-0	H1N001
101-874	AN-907	202-520	MT-901	822-250-0	D1N035
101-882	AT-049	202-553	MN-133	822-278-0	B1N025
101-883	AY-003L	202-568	ME-OP01	822-295-0	F1N014
101-884	AY-003R	202-590	BMT-295	822-296-0	F1N013
101-886	WCT-022	202-592	MT-203	822-298-0	C1N018
101-887	AT-048R	202-593	MT-204	822-302-0	E2N033
101-888	AT-045R	202-648	MT-902	822-302-1	E2N033
101-889	AT-045L	202-651	MN-906	822-303-0	E2N027
101-890	WCT-026	822-034-1	B1N012	822-370-0	E1N013
101-895	WCT-069	822-066-0	B1N003	822-383-0	C1N036
101-896	WCT-076	822-068-0	E1N035	822-384-0	C1N034
101-905	WCT-081	822-107-0	B1N003	822-385-0	C1N014
101-906	AY-017L	822-107-1	B1N011	822-387-0	E1N003
101-909	AK-002	822-115-0	D1N033	822-389-0	E2N032
101-920	AS-031R	822-134-0	D1N034	822-390-0	G2N010
101-922	AY-011L	822-135-0	F1N010	822-393-0	E2N029
101-923	AY-011R	822-138-0	C1N020	822-396-0	D2N040
101-927	WCD-001	822-151-0	D2N037	822-397-0	D1N021
101-928	WCD-005	822-167-0	A1N041	822-398-0	D2N032
101-929	AF-010	822-169-0	C2N010	822-399-0	D1N003
101-931	AM-005	822-170-0	C2N022	822-401-0	D1N042
101-963	AN-052	822-170-1	C2N010	822-403-0	B2N029
202-144	MZ-003	822-171-0	C1N013	822-407-0	B1N018
202-145	MH-001	822-172-0	C1N023	822-408-0	B2N050
202-209	MH-005	822-173-0	C2N021	822-414-0	F2N015
202-210	MH-003	822-175-0	C1N016	822-419-0	H1N020
202-211	MH-015	822-176-0	C2N022	822-438-0	H1N006
202-214	MH-009	822-190-1	B1N020	822-473-0	E1N038
202-220	MN-901	822-193-0	B2N022	822-483-0	D2N036
202-249	MN-099	822-193-1	B2N022	822-484-0	D2N022
202-315	MH-021	822-196-0	E1N014	822-612-0	B2N064
202-321	MH-028	822-197-0	E1N016	822-613-0	F2N016
202-328	MH-040	822-204-0	F2N012	822-614-0	A1N065
202-331	MZ-051	822-221-0	D1N013	822-735-0	E2N048
202-336	MO-018	822-221-1	D1N013	822-737-0	D2N049
202-342	MN-109	822-223-0	E1N026		
202-343	MS-018	822-224-0	D1N035		

# CROSS REFERENCE LIST

## FERODO N<sup>R</sup> TO AISIN N<sup>R</sup>

FERODO N <sup>R</sup>	AISIN N <sup>R</sup>	FERODO N <sup>R</sup>	AISIN N <sup>R</sup>	FERODO N <sup>R</sup>	AISIN N <sup>R</sup>
FDB1013	D2N040	FDB507	D2N028	FHM1176	MG-004
FDB1020	H1N007	FDB547	E1N009	FHM1185	MY-003
FDB1025	E1N038	FDB556	D1N033	FHM1191	MO-009
FDB1091	B1N025	FDB576	E1N035	FHM1194	MO-007
FDB1092	D1N035	FDB585	C1N013	FHM1195	MO-010
FDB1100	H1N016	FDB597	E1N013	FHM1213	MM-054
FDB1104	B2N022	FDB600	B1N020	FHM1219	MO-005
FDB1108	H1N005	FDB602	A1N038	FHM1246	MH-005
FDB1263	B1N062	FDB621	C2N010	FHM1247	MH-004
FDB1327	F1N013	FDB630	E2N036	FHM1248	MH-010
FDB1333	F2N015	FDB641	B1N011	FHM1249	MN-097
FDB1368	A1N067	FDB654	G2N010	FHM1250	MN-022
FDB1392	A1N055	FDB691	B1N020	FHM1251	MN-902
FDB1421	H1N020	FDB708	C1N036	FHM1252	MG-005
FDB1422	D1N042	FDB712	H1N004	FHM1255	BMT-022
FDB1437	A1N097	FDB714	E1N016	FHM1256	BMT-061
FDB1454	B2N029	FDB715	E1N014	FHW041	AE-OP02
FDB1455	E1N003	FDB717	B1N004	FHW055	WCT-061
FDB1456	A1N005	FDB748	C1N013	FHW120	AS-013
FDB1458	A1N034	FDB757	E1N009	FHW174	AN-012
FDB1502	A1N023	FDB759	D1N014	FHW176	47550-20130
FDB1503	E1N016	FDB764	D1N035	FHW177	WCT-009
FDB1507	D2N036	FDB765	D1N034	FHW181	AH-002R
FDB1528	A1N068	FDB776	C1N016	FHW182	AH-002L
FDB1532	G1N006	FDB777	C1N020	FHW190	AN-002
FDB1554	A1N025	FDB778	C1N016	FHW196	AN-901L
FDB1565	H1N001	FDB789	F1N010	FHW197	AN-901R
FDB1570	D2N022	FDB790	F2N012	FHW198	AN-052L
FDB1577	B1N018	FDB796	B2N022	FHW199	AN-052R
FDB1596	D1N021	FDB797	A1N021	FHW203	AH-005L
FDB1603	D1N003	FDB804	D2N037	FHW208	AN-011
FDB1612	F1N014	FDB867	A1N048	FHW312	AG-001
FDB1679	C2N015	FDB868	A1N041	FHW313	WCT-017
FDB1693	B2N064	FDB870	E1N026	FHW327	AH-019R
FDB1721	E2N033	FDB8797	A1N021	FHW328	AH-019L
FDB1731	A2N111	FDB902	A1N020	FHW338	AY-007L
FDB1839	D2N049	FDB904	C1N023	FHW4020	AO-001
FDB186	A1N061	FDB905	C1N018	FHW4021	AN-053
FDB1861	F2N016	FDB928	A1N053	FHW4024	AZ-009
FDB1892	A2N130	FDB930	A1N085	FHW4026	AK-001
FDB1948	A2N040	FDB932	A1N085	FHW4028	AN-906
FDB1981	B1N025	FDB939	E1N035	FHW4045	AH-015L
FDB265	A1N078	FDB943	A1N043	FHW405	AN-904
FDB281	A1N016	FDB949	A1N049	FHW4050	AS-030
FDB283	A2N075	FDB950	E1N026	FHW4052	AH-015R
FDB284	B2N008	FDB956	C2N015	FHW4053	AM-019
FDB288	A1N017	FHM1059	MN-126	FHW4055	AK-002
FDB293	B1N009	FHM1118	MH-021	FHW4068	WCT-002
FDB300	C1N004	FHM1128	MH-040	FHW4076	AZ-024
FDB308	A1N034	FHM1146	MN-903	FHW4077	AN-013
FDB316	B1N012	FHM1152	MS-031	FHW4080	AY-003R
FDB318	A1N036	FHM1153	MH-003	FHW4081	AZ-009
FDB340	B1N003	FHM1154	MH-003	FHW4084	AY-003L
FDB372	E2N033	FHM1155	MH-020	FHW4086	AM-005
FDB396	H1N011	FHM1156	MN-099	FHW4087	AS-023
FDB454	C1N033	FHM1157	MN-901	FHW4092	47550-16060
FDB472	C2N022	FHM1158	MH-002	FHW4096	WCT-074
FDB478	A1N028	FHM1167	MH-001	FHW4106	WCT-014
FDB482	E2N032	FHM1175	MO-004	FHW4109	AN-001

# CROSS REFERENCE LIST

## FERODO N<sup>R</sup> TO AISIN N<sup>R</sup>

FERODO N <sup>R</sup>	AISIN N <sup>R</sup>	FERODO N <sup>R</sup>	AISIN N <sup>R</sup>	FERODO N <sup>R</sup>	AISIN N <sup>R</sup>
FHW4110	WCT-048	FHW4189	WCT-068	FHW4267	AN-026
FHW4111	WCT-015	FHW419	AN-903	FHW4268	AO-003
FHW4112	AS-022L	FHW4190	AN-010	FHW4270	WCT-184
FHW4114	WCT-069	FHW4191	AG-002LR	FHW4275	AZ-002
FHW4118	AK-004	FHW4192	AH-003R	FHW4276	AN-902R
FHW4121	AH-003R	FHW4195	AM-013	FHW4277	AN-902L
FHW4123	WCT-039	FHW4196	AM-010R	FHW4279	AH-017
FHW4124	AS-008	FHW4199	AS-006R	FHW4285	AY-001
FHW4127	AT-050	FHW4200	AS-007R	FHW4286	WCT-018
FHW4128	AY-004L	FHW4203	AS-001L	FHW4287	WCT-013
FHW4130	AM-004	FHW4212	AF-009	FHW4288	AZ-001
FHW4131	AD-006L	FHW4213	AS-025	FHW4289	AE-OP01
FHW4134	AN-003	FHW4214	AS-026	FHW4290	AZ-023R
FHW4138	AN-016	FHW4217	WCT-024	FHW4291	AZ-023L
FHW4144	AM-003L	FHW4218	AH-004	FHW4293	AN-044
FHW4145	AY-004R	FHW4219	AH-003R	FHW4316	WCT-010
FHW4146	AN-053	FHW4220	AH-003L	FHW4317	WCT-006
FHW4148	WCT-005	FHW4221	AF-001	FHW4318	AM-006R
FHW4149	AF-002	FHW4222	AH-002R	FHW4319	AM-006L
FHW4152	AY-011R	FHW4223	WCT-010	FHW4320	WCT-019
FHW4153	AD-006R	FHW4224	AN-017	FHW4321	AH-001L
FHW4154	AH-003L	FHW4227	AN-007	FHW4322	AH-001R
FHW4155	AS-022R	FHW4233	WCT-072	FHW4325	WCT-051
FHW4159	AS-007L	FHW4235	WCD-005	FHW4326	AF-005
FHW4163	AM-001R	FHW4236	WCD-001	FHW4327	AN-048
FHW4164	AM-003R	FHW4237	AM-009	FHW4328	AF-006
FHW4165	AY-011L	FHW4238	AS-021	FHW4331	AN-052
FHW4166	WCT-076	FHW4239	AN-035	FHW4332	WCT-007
FHW4167	AN-012	FHW4240	47550-35190	FHW4334	AT-046R
FHW4170	AM-001L	FHW4241	WCT-174	FHW4335	WCT-081
FHW4172	AO-002	FHW4242	AY-001	FHW4336	AY-016R
FHW4174	AZ-003	FHW4243	AM-010L	FHW4342	AN-051
FHW4175	AH-003L	FHW4246	47550-30100	FHW4365	AD-003
FHW4176	WCT-003	FHW4247	AT-046L	FHW4366	AS-015
FHW4177	47550-35160	FHW4252	AF-010	FHW4371	WCT-078
FHW4178	AN-008	FHW4256	AY-001	FHW4372	AM-007
FHW4179	AT-045L	FHW4259	AN-004	FHW4373	AS-005L
FHW4180	AT-045R	FHW4260	AY-001	FHW4374	AS-005R
FHW4184	AZ-005	FHW4261	AY-012L	FHW450	AT-049
FHW4186	AS-006L	FHW4262	AY-012R	FSL757	E1N009
FHW4187	AS-020R	FHW4263	WCT-070	FSL949	A1N049
FHW4188	AS-020L	FHW4264	WCT-075	FVR547	E1N008

# CROSS REFERENCE LIST

## FTE N<sup>R</sup> TO AISIN N<sup>R</sup>

FTE N <sup>R</sup>	AISIN N <sup>R</sup>	FTE N <sup>R</sup>	AISIN N <sup>R</sup>	FTE N <sup>R</sup>	AISIN N <sup>R</sup>
BL1192A1	B1N009	BL1640A2	D1N042	R17044.8.1	AN-904
BL1236A2	B1N003	BL1643A2	H1N001	R17047.2.1	AZ-009
BL1245A1	H1N011	BL1649A2	B2N029	R17065.2.1	AO-001
BL1288A2	C2N022	BL1673A2	E1N003	R17069.3.1	AS-027L
BL1300A2	E1N013	BL1701A2	A1N101	R17070.3.1	AS-027R
BL1306A2	A1N036	BL1702A1	A1N034	R17071.2.1	AM-013
BL1309A2	E1N035	BL1712A2	B1N062	R17072.2.1	AH-017
BL1321A2	C1N013	BL1713A2	B1N018	R190004.2.1	AZ-036
BL1330A2	F1N010	BL1714A2	H1N020	R190005.7.1	AN-051
BL1331A2	C1N034	BL1715A2	A1N067	R190018.2.1	AH-003L
BL1332A2	H1N004	BL1792A2	F1N013	R190019.2.1	AH-003R
BL1336A2	B1N020	BL1807A2	C2N015	R190027.3.1	AT-049
BL1342A2	B2N008	BL1809A2	D1N003	R190028.2.1	AZ-024
BL1344A1	G2N010	BL1811A2	D2N022	R190029.2.1	AH-019L
BL1345A2	B1N019	BL1842A2	G1N006	R190030.2.1	AH-019R
BL1353A2	A1N048	BL1845A2	A1N068	R190031.2.1	AM-004
BL1362A2	D1N035	BL1850A3	E2N033	R190037.2.1	AM-005
BL1363A2	D1N014	BL1854A2	F1N014	R190038.2.1	AO-003
BL1364A2	C1N018	BL1855A2	F2N015	R19031F1	AE-FO01
BL1365A2	E1N014	BL1865A2	G1N018	R19082A1	AE-OP02
BL1370A2	A1N021	BL1879A1	A1N065	R19097.8.1	AH-015L
BL1371A1	A2N047	BL1880A2	A2N007	R19098.8.1	AH-015R
BL1372A1	A1N049	BL1884A2	A2N069	R200001A1	AO-002
BL1373A2	C1N016	BL1905A3	E2N033	R200025.8.1	AN-903
BL1374A2	C1N020	BL1915A2	D2N036	R200033.2.1	AK-002
BL1375A2	F2N012	BL1917A2	D2N049	R20045A1	AN-901L
BL1376A2	D2N032	BL1918A1	D1N021	R20046A1	AN-901R
BL1378A2	B2N022	BL1919A2	A1N096	R20047A1	AN-052L
BL1379A2	B1N054	BL1920A1	A2N066	R20048A1	AN-052R
BL1380A2	C2N015	BL1925A2	B2N064	R220031.2.1	AM-001R
BL1385A2	E1N026	BL1956A2	A2N031	R220047.2.1	AY-010L
BL1386A2	A2N044	BL1990A1	A2N104	R220048.2.1	AY-010R
BL1387A1	E2N027	H209115.7.1	MH-041	R220049.2.1	AM-001L
BL1388A2	D1N034	H209125.2.1	MO-007	R23035A1	AN-906
BL1393A2	A2N081	H209128.2.1	MO-011	R23047.2.1	AN-052
BL1394A2	A1N085	H229002.8.1	MM-069	R23048.2.1	AM-010L
BL1396A2	D2N037	H229035.7.1	MH-032	R23049.2.1	AM-010R
BL1401A2	J2N009	H229049.7.1	MO-009	R25060.2.1	AN-007
BL1402A2	C1N023	H229050.7.1	MO-013	RX309801A0	EZ-038LR
BL1407A1	A1N053	H229051.7.1	MO-014	RX309802A0	EZ-038RR
BL1409A2	B1N025	H229052.7.1	MO-010	RX309803A0	EZ-036LR
BL1490A4	D2N040	H229053.2.1	MO-018	RX309804A0	EZ-036RR
BL1496A2	A1N043	H22969.0.1	MN-901	RX549881A0	EZ-017L
BL1506A2	H1N007	H239015.0.1	MN-120	RX549882A0	EZ-017R
BL1507A2	H1N016	H239061.3.1	MH-020	RX549883A0	ET-071L
BL1544A2	C2N022	H25957.3.1	MN-138	RX549884A0	ET-071R
BL1626A2	D2N040	R15034.2.1	AN-002	RX579819A0	EZ-031L
BL1629A2	E2N029	R15041.2.1	WCT-048	RX579820A0	EZ-031R
BL1632A2	E1N038	R17010D1	AZ-035		
BL1636A2	E1N016	R17028C1	AE-OP01		

# CROSS REFERENCE LIST

## HP N<sup>R</sup> TO AISIN N<sup>R</sup>

HP N <sup>R</sup>	AISIN N <sup>R</sup>	HP N <sup>R</sup>	AISIN N <sup>R</sup>	HP N <sup>R</sup>	AISIN N <sup>R</sup>
2079	B1N020	2909	E1N038	BC50931	EN-084LR
2375	C1N013	2917	D2N040	BC50945	EY-003R
2394	H1N011	2928	E1N016	BC51004	EH-023L
2403	C2N010	2941	H1N016	BC51005	EH-023R
2427	B1N003	2944	D1N035	BC51006	EZ-005L
2429	B1N004	2945	D1N042	BC51009	EM-003L
2457	B2N016	2965	B2N022	BC51010	EM-003R
2480	E2N032	2966	B2N016	BC51013	EN-048R
2485	B2N045	2976	B2N029	BC51045	EN-068LR
2487	B1N003	7016	D1N014	BC51046	EN-068RR
2488	B1N012	7026	A1N048	BC51047	EZ-015L
2489	C1N033	7051	H1N001	BC51048	EZ-015R
2505	B1N009	7054	F1N014	BC51049	EZ-006L
2508	C2N022	7055	F1N013	BC51050	EZ-006R
2527	E1N008	7056	C2N015	BC51051	EZ-017L
2550	B1N011	7057	H1N006	BC51052	EZ-017R
2587	A1N036	7076	B2N057	BC51053	EZ-016L
2588	D1N033	7085	D2N012	BC51054	EZ-016R
2590	C1N004	7104	B1N018	BC51055	EZ-029L
2591	E1N013	7121	H1N020	BC51056	EZ-029R
2597	E2N036	7122	E1N003	BC51061	EZ-038LR
2598	E1N035	7154	B1N062	BC51062	EZ-038RR
2613	B1N011	7160	G1N006	BC51071	EZ-031L
2616	D2N028	7187	D2N036	BC51072	EZ-036RR
2620	D1N033	7188	D1N021	BC51073	EZ-040LR
2623	E1N009	7230	D2N022	BC51074	EZ-040RR
2626	E2N033	7237	F2N015	BC51085	EZ-003L
2638	C2N010	7249	E2N033	BC51086	EZ-003R
2652	B1N020	7255	E1N026	BC51097	EN-066L
2660	B1N019	7257	C2N021	BC51098	EN-066R
2667	D2N032	7262	D1N035	BC51099	EN-017L
2702	F1N010	7263	E2N033	BC51100	EN-017R
2703	F2N012	7264	C2N022	BC51103	EN-023L
2709	G2N010	7288	E2N033	BC51104	EN-023R
2710	C2N015	7308	D1N003	BC51111	EN-029L
2717	E1N014	7310	A1N065	BC51112	EN-029R
2718	E1N035	7405	B2N064	BC51113	EN-026L
2724	C1N034	7434	B2N022	BC51114	EN-026R
2726	C1N013	7453	C2N021	BC51117	EN-080L
2727	C2N022	7537	E2N033	BC51118	EN-080R
2731	E1N016	7591	D2N049	BC51121	EN-051L
2741	D1N035	7710	F2N016	BC51122	EN-051R
2762	B2N022	7719	B2N064	BC51125	EN-078L
2785	C1N018	7723	B1N025	BC51126	EN-078R
2786	C2N015	7742	E2N048	BC51131	EN-063LR
2800	A1N041	BC12220	EN-028R	BC51139	EN-052LR
2803	C1N016	BC13228	EZ-005R	BC51140	EN-052RR
2806	C1N020	BC26119	EH-009L	BC51143	EN-076LR
2816	C1N014	BC32101	EZ-036LR	BC51144	EN-076RR
2820	D1N034	BC32104	EZ-031R	BC51147	EN-045L
2821	D1N014	BC50571	EH-004L	BC51148	EN-045R
2830	A1N048	BC50572	EH-004R	BC51151	EN-085LR
2834	C1N023	BC50670	EN-028L	BC51152	EN-085RR
2848	E1N026	BC50908	ES-007L	BC51155	EN-062L
2861	D2N036	BC50909	ES-007R	BC51157	EN-064LR
2867	E2N027	BC50917	EH-035L	BC51158	EN-064RR
2868	D2N032	BC50918	EH-035R	BC51161	EM-016L
2901	A1N028	BC50921	EH-007L	BC51162	EM-016R
2904	E2N030	BC50922	EH-007R	BC51163	EM-019L



# CROSS REFERENCE LIST

## HP N<sup>R</sup> TO AISIN N<sup>R</sup>

HP N <sup>R</sup>	AISIN N <sup>R</sup>	HP N <sup>R</sup>	AISIN N <sup>R</sup>	HP N <sup>R</sup>	AISIN N <sup>R</sup>
BC51164	EM-019R	BM30353	BMT-088	BM30475	MM-059
BC51165	EM-013L	BM30354	47201-20871	BM30477	MM-071
BC51166	EM-013R	BM30355	47201-20881	BM30481	MN-109
BC51167	EM-023L	BM30356	BMT-007	BM30484	MN-119
BC51168	EM-023R	BM30357	47201-27240	BM30485	MN-122
BC51169	EM-018L	BM30358	BMT-084	BM30490	MH-041
BC51170	EM-018R	BM30359	BMT-110	BM30491	MH-032
BC51171	EM-017L	BM30360	MT-115	BM30493	MH-027
BC51172	EM-017R	BM30361	BMT-015	BM30494	MH-037
BC51173	EM-028LR	BM30362	BMT-099	BM30501	MS-030
BC51174	EM-028RR	BM30363	BMT-063	BM30502	BMS-003
BC51177	EM-006L	BM30364	BMT-010	BM30504	BMS-008
BC51178	EM-035RR	BM30365	47201-32170	BM30505	MS-026
BC51181	EM-038L	BM30366	BMT-114	BM30510	BMS-009
BC51182	EM-038R	BM30367	BMT-069	BM30515	BMT-061
BC51183	EM-042LR	BM30368	BMT-056	BM30516	MH-006
BC51184	EM-042RR	BM30370	BMS-010	BM30521	MH-009
BC51189	EM-036L	BM30372	MH-043	BM30523	MN-005
BC51190	EM-036R	BM30374	MH-028	BM30524	MN-129
BC51191	EM-037LR	BM30375	MH-029	BM30526	MN-022
BC51192	EM-037RR	BM30376	MH-017	BM30527	MM-004
BC51253	EH-019L	BM30379	MH-022	BM30528	MM-009
BC51254	EH-019R	BM30380	MH-023	BM30529	MM-051
BC51255	EH-024LR	BM30383	MH-018	BM30530	MM-034
BC51256	EH-024RR	BM30386	MH-010	BM30531	MZ-044
BC51266	EH-036LR	BM30387	MH-013	BM30532	MZ-013
BC51267	EH-036RR	BM30389	MH-020	BM30533	BMT-172
BC51275	EH-013L	BM30390	MH-021	BM30535	BMT-113
BC51276	EH-013R	BM30391	MH-046	BM30536	47201-20390
BC51279	EH-034L	BM30392	MH-008	BM30537	47201-20550
BC51280	EH-034R	BM30393	MH-004	BM30538	BMT-060
BC51295	ES-003L	BM30394	MH-030	BM30539	BMT-107
BC51296	ES-003R	BM30395	BMS-001	BM30540	BMT-022
BC51297	EY-001L	BM30396	51100-70A00	BM30543	MS-018
BC51298	EY-001R	BM30397	BMS-004	BM30544	MS-010
BC51313	EY-002L	BM30398	MS-003	BM30547	MZ-035
BC51314	EY-002R	BM30400	MS-007	BM30557	MZ-051
BC51321	EY-004LR	BM30402	MY-027	BM30559	MZ-016
BC51335	EM-033L	BM30404	MF-012	BM30560	MZ-015
BC51336	EM-033R	BM30405	MF-005	BM30561	MZ-007
BC51337	EH-009R	BM30409	MO-017	BM30562	MZ-043
BM04720	ME-OP01	BM30410	MO-018	BM30563	MZ-088
BM07003	MZ-042	BM30413	MO-011	BM30571	MZ-048
BM07008	MZ-018	BM30416	MO-009	BM30572	MZ-056
BM08400	MS-031	BM30417	MO-013	BM30573	MZ-019
BM30149	MH-044	BM30419	MO-010	BM30574	MZ-055
BM30202	MM-069	BM30420	MO-014	BM30575	MZ-017
BM30209	MN-016	BM30421	MO-003	BM30580	MZ-002
BM30233	MN-120	BM30432	MD-033	BM30581	MZ-033
BM30315	MN-138	BM30435	MY-011	BM30583	MZ-036
BM30338	MM-040	BM30436	MY-016	BM30584	MZ-049
BM30340	BMT-106	BM30439	MY-001	BM30585	MN-117
BM30341	MT-109	BM30440	MY-005	BM30586	MN-003
BM30342	47201-16180	BM30443	MY-019	BM30588	MN-094
BM30343	BMT-115	BM30444	MY-020	BM30589	MN-111
BM30345	47201-17070	BM30446	MY-006	BM30590	MN-091
BM30346	47201-17090	BM30447	MY-007	BM30591	MN-118
BM30349	MT-105	BM30472	MM-042	BM30592	MN-090
BM30350	MT-008	BM30474	MM-038	BM30593	MN-098



# CROSS REFERENCE LIST

## HP N<sup>R</sup> TO AISIN N<sup>R</sup>

HP N <sup>R</sup>	AISIN N <sup>R</sup>	HP N <sup>R</sup>	AISIN N <sup>R</sup>	HP N <sup>R</sup>	AISIN N <sup>R</sup>
BM30594	MN-100	BM30637	BMT-009	BM30692	MY-029
BM30597	MN-134	BM30643	BMT-267	BM30697	MN-121
BM30601	MD-031	BM30646	MT-106	BM30698	MN-124
BM30604	MN-070	BM30648	BMT-004	BM30702	MF-011
BM30606	BMT-052	BM30649	BMT-275	BM30703	ME-CI01
BM30607	47201-3D040	BM30653	BMT-131	BM30704	BMT-048
BM30609	MM-024	BM30654	BMT-132	BM30705	BMT-039
BM30610	MM-026	BM30658	MT-206	BM30706	BMT-149
BM30611	MM-011	BM30662	BMT-224	BM30707	MT-901
BM30612	MM-031	BM30664	BMT-301	BM30808	MN-099
BM30614	MM-027	BM30667	BMT-044	BM30862	MN-901
BM30615	MM-063	BM30669	BMT-008	BM30880	MH-003
BM30616	MM-012	BM30671	BMT-068	BM30881	MO-004
BM30617	MM-052	BM30672	BMT-304	BM30882	MO-005
BM30618	MM-057	BM30674	BMT-236	BM30884	MN-902
BM30619	MM-053	BM30680	MM-070	BM30885	MN-126
BM30620	MM-066	BM30682	MM-045	BM30886	MH-001
BM30621	MM-055	BM30683	MM-054	BM30894	MF-900
BM30633	MT-011	BM30684	MY-018	BM31179	BMT-151
BM30634	BMT-262	BM30686	MY-013	BM31180	BMT-155

# CROSS REFERENCE LIST

## ICER BRAKES N<sup>R</sup> TO AISIN N<sup>R</sup>

ICER BRAKES N <sup>R</sup>	AISIN N <sup>R</sup>	ICER BRAKES N <sup>R</sup>	AISIN N <sup>R</sup>	ICER BRAKES N <sup>R</sup>	AISIN N <sup>R</sup>
140313	A1N036	180631	E2N033	181169	A1N053
140352	A1N017	180646	B2N016	181186	G2N010
140444	B2N016	180656	A2N044	181187	C2N021
140518	B1N003	180704	C1N013	181209	A1N038
140524	A1N091	180734	A2N081	181210	A1N048
140526	B1N003	180750	C1N033	181247	F1N013
140614	A1N036	180751	C2N022	181304	A1N067
140687	E1N008	180752	C2N010	181309	E1N003
140690	E1N009	180753	C2N022	181318	F1N014
140701	D1N033	180771	D1N035	181319	H1N001
140876	B2N022	180785	E2N033	181342	G1N018
140884	B1N011	180795	E1N035	181374	D1N003
140885	B1N011	180797	C1N034	181386	A1N068
140914	B2N022	180798	C2N015	181408	A1N034
140979	D1N034	180875	D1N014	181443	D1N021
140980	D2N032	180879	E1N016	181448	B1N018
140983	D2N036	180882	B1N017	181452	G1N006
140991	J2N009	180888	A1N043	181509	B2N064
141002	H1N004	180958	C1N020	181520	A2N031
141006	A1N021	180959	C1N016	181521	B1N062
141007	A1N021	180962	C1N013	181554	C1N014
141009	A1N036	180969	E1N014	181555	A1N101
141010	A1N049	180970	E1N014	181589	H1N020
141025	A1N029	180971	E1N026	181607	A2N007
141026	A1N023	180981	D2N032	181608	A2N069
141027	A2N012	180982	D2N040	181632	A1N097
141057	A1N085	180984	B1N054	181633	A2N066
141096	H1N007	180985	B1N020	181667	B2N040
141170	A1N050	180986	B1N020	181704	A1N065
141234	D1N042	180998	F1N010	181706	A2N104
141251	H1N006	180999	F1N010	181719	D2N022
141337	E1N038	181000	F2N012	181723	A1N005
180353	A1N016	181004	A1N038	181734	A2N004
180409	B1N009	181005	A1N048	181736	F2N015
180462	A1N034	181019	C1N018	181737	F2N016
180463	A1N034	181020	C1N023	181742	E2N048
180468	H1N011	181024	C2N022	181746	D2N049
180492	C1N004	181045	C2N022	181751	A2N111
180494	C1N004	181095	B2N029	181761	A2N130
180519	B1N009	181101	B1N019	181817	A2N047
180520	B1N004	181110	E2N027	181819	E2N030
180530	B1N012	181116	H1N016	181820	A1N105
180540	D2N028	181117	D1N035	181875	A2N159
180600	C2N010	181129	D1N014	180612-071	A2N075
180609	C1N036	181133	C1N014	180971-203	E1N026
180612	A2N075	181134	H1N005	181749-200	B2N053
180619	A2N080	181144	B2N008	181819-204	E2N029
180621	E2N032	181153	B1N025		
180624	A2N076	181160	E2N036		

# CROSS REFERENCE LIST

## JAPANPARTS N<sup>R</sup> TO AISIN N<sup>R</sup>

JAPANPARTS N <sup>R</sup>	AISIN N <sup>R</sup>	JAPANPARTS N <sup>R</sup>	AISIN N <sup>R</sup>	JAPANPARTS N <sup>R</sup>	AISIN N <sup>R</sup>
CD-199	AN-901R	CS-457	AS-028L	PA-143AF	B1N019
CD-400	AH-002R	CS-459	AH-003L	PA-144AF	B1N020
CD-401	AH-003R	CS-500	AM-002R	PA-178AF	B1N018
CD-403	AH-003R	CS-501	AM-002L	PA-195AF	B1N004
CD-815	AS-005R	CS-502	AM-006R	PA-203AF	A1N068
CS-100	AN-015	CS-503	AM-006L	PA-214AF	A1N049
CS-106	AN-020	CS-508	AM-011R	PA-224AF	A1N049
CS-107	AN-002	CS-509	AM-011L	PA-232AF	A1N016
CS-109	AN-017	CS-514	AM-019	PA-235AF	A1N034
CS-110	AN-008	CS-531	AM-004	PA-236AF	A1N017
CS-111	AN-052	CS-532	AM-004	PA-237AF	A1N038
CS-125	AN-051	CS-533	AM-007	PA-245AF	A1N041
CS-150	AN-025	CS-534	AM-003L	PA-247AF	A1N036
CS-161	AN-903	CS-535	AM-003R	PA-254AF	A1N021
CS-168	AN-029	CS-536	AM-009	PA-255AF	A1N023
CS-169	AN-012	CS-537	AM-001R	PA-259AF	A1N085
CS-170	AN-026	CS-538	AM-001L	PA-264AF	A1N048
CS-171	AN-013	CS-539	AM-013	PA-281AF	A1N067
CS-172	AN-001	CS-569	AM-012	PA-292AF	A1N023
CS-173	AN-004	CS-579	AM-005	PA-293AF	A1N028
CS-175	AN-005	CS-588	AM-018	PA-295AF	A1N056
CS-176	AN-010	CS-593	AM-010R	PA-311AF	E1N003
CS-178	AN-035	CS-594	AM-010L	PA-326AF	E1N009
CS-179	AN-042	CS-703	AF-009	PA-331AF	E1N035
CS-180	AN-016	CS-704	AF-005	PA-332AF	E1N013
CS-187	AN-049	CS-705	AF-010	PA-341AF	E1N014
CS-188	AN-904	CS-711	AF-006	PA-342AF	E1N016
CS-190	AN-003	CS-712	AF-010	PA-399AF	E1N026
CS-191	AN-011	CS-713	AF-009	PA-414AF	C1N004
CS-196	AN-007	CS-798	AF-008	PA-421AF	C1N013
CS-199	AN-901L	CS-813	AS-021	PA-424AF	C1N033
CS-209	WCT-189	CS-820	AS-007R	PA-425AF	C1N020
CS-303	AZ-003	CS-821	AS-007L	PA-426AF	C1N013
CS-307	AZ-034	CS-822	AS-005L	PA-432AF	C1N018
CS-312	AZ-005	CS-824	AS-031R	PA-435AF	C1N016
CS-313	AZ-001	CS-829	AS-026	PA-493AF	C1N023
CS-318	AZ-036	CS-830	AS-025	PA-505AF	D1N021
CS-325	AK-003	CS-832	AS-022R	PA-509AF	D1N003
CS-352	AZ-019L	CS-837	AS-022L	PA-525AF	D1N014
CS-353	AZ-019R	CS-842	AS-028R	PA-527AF	D1N033
CS-355	AZ-016R	CS-894	AT-050	PA-528AF	D1N014
CS-356	AZ-011L	CS-H07	AY-010L	PA-530AF	D1N035
CS-357	AZ-011R	CS-H08	AY-010R	PA-585AF	D1N042
CS-362	AZ-004L	CS-H11	47550-20130	PA-590AF	E1N026
CS-363	AZ-004R	CS-H14	47570-20040	PA-599AF	D1N034
CS-365	AZ-006R	CS-H21	AY-017L	PA-705AF	F1N010
CS-368	AZ-013	CS-H22	AY-017R	PA-711AF	F1N014
CS-369	AZ-007R	CS-K00	AK-001	PA-796AF	F1N013
CS-396	AZ-023R	CS-K01	AK-002	PA-803AF	H1N011
CS-397	AZ-023L	CS-K02	AK-004	PA-806AF	H1N004
CS-398	AZ-024	CS-K05	AK-002	PA-813AF	H1N020
CS-399	WCT-048	CS-W00	AE-OP01	PA-816AF	H1N016
CS-401	AH-002L	CS-W01	AE-OP02	PA-893AF	H1N001
CS-410	AH-019L	CS-W02	AO-001	PA-897AF	H1N007
CS-435	AH-017	CS-W03	AO-002	PF-100	MN-015
CS-452	AH-004	CS-W06	AO-003	PF-102	MN-043
CS-453	AH-001L	PA-103AF	B1N012	PF-106	MN-013
CS-454	AH-001R	PA-111AF	B1N004	PF-108	MN-047
CS-456	AH-003L	PA-137AF	B1N011	PF-112	MN-045

# CROSS REFERENCE LIST

## JAPANPARTS N<sup>R</sup> TO AISIN N<sup>R</sup>

JAPANPARTS N <sup>R</sup>	AISIN N <sup>R</sup>	JAPANPARTS N <sup>R</sup>	AISIN N <sup>R</sup>	JAPANPARTS N <sup>R</sup>	AISIN N <sup>R</sup>
PF-114	MN-040	PF-503	MM-038	PF-W10	MO-005
PF-115	MN-067	PF-505	MM-024	PF-W11	MO-018
PF-121	MN-123	PF-507	MM-026	PF-W12	MO-006
PF-122	MN-053	PF-510	MM-013	PF-W13	MO-016
PF-126	MN-126	PF-514	MM-048	PF-W15	MO-021
PF-132	MN-050	PF-515	MM-036	PP-121AF	B2N016
PF-135	MN-022	PF-516	MM-042	PP-122AF	B2N016
PF-158	MN-122	PF-522	MM-004	PP-123AF	B2N008
PF-159	MN-121	PF-523	MF-004	PP-124AF	B2N045
PF-184	MN-107	PF-524	MM-019	PP-127AF	B2N022
PF-185	MN-106	PF-525	MM-022	PP-128AF	B2N050
PF-186	MN-012	PF-528	MM-040	PP-154AF	B2N064
PF-187	MN-023	PF-531	MM-052	PP-196AF	B2N029
PF-188	MN-081	PF-532	MM-053	PP-203AF	A2N007
PF-191	MN-105	PF-535	MM-037	PP-204AF	A2N044
PF-197	MN-903	PF-551	MM-070	PP-206AF	A2N080
PF-199	MN-003	PF-589	MM-034	PP-207AF	A2N076
PF-220	BMT-269	PF-590	MM-043	PP-210AF	A2N012
PF-270	BMT-048	PF-591	MM-002	PP-211AF	A2N111
PF-297	BMT-131	PF-592	MM-045	PP-212AF	A2N042
PF-299	BMT-029	PF-593	MM-062	PP-213AF	A2N051
PF-301	MZ-004	PF-594	MM-030	PP-218AF	A2N130
PF-305	MZ-029	PF-595	MM-040	PP-256AF	A2N031
PF-314	MZ-012	PF-597	MM-016	PP-258AF	A2N069
PF-316	MZ-003	PF-598	MM-011	PP-262AF	A2N047
PF-320	MZ-005	PF-599	MM-001	PP-294AF	A2N080
PF-329	MZ-013	PF-702	MF-008	PP-302AF	E2N033
PF-332	MZ-039	PF-703	MF-013	PP-303AF	E2N032
PF-334	MZ-015	PF-704	MF-005	PP-305AF	E2N028
PF-335	MZ-017	PF-705	MF-004	PP-306AF	E2N036
PF-384	MZ-036	PF-801	BMS-010	PP-307AF	E2N027
PF-387	MZ-002	PF-809	BMS-007	PP-391AF	E2N030
PF-390	MZ-007	PF-819	MS-032	PP-404AF	C2N022
PF-391	MZ-048	PF-893	BMS-001	PP-405AF	C2N015
PF-392	MZ-019	PF-896	51100-70A00	PP-500AF	D2N028
PF-393	MZ-006	PF-898	MS-031	PP-504AF	D2N040
PF-396	MZ-016	PF-899	BMS-004	PP-508AF	D2N049
PF-398	MZ-042	PF-H09	MY-022	PP-592AF	D2N022
PF-409	MH-001	PF-H10	MY-023	PP-594AF	D2N032
PF-410	MH-020	PF-H14	MY-032	PP-599AF	D2N037
PF-413	MH-003	PF-S98	MY-012	PP-601AF	G2N010
PF-415	MH-003	PF-W03	MO-007	PP-701AF	F2N012
PF-416	MH-003	PF-W04	MO-010	PP-702AF	F2N015
PF-419	MH-021	PF-W05	MO-009	PP-703AF	F2N016
PF-435	MH-040	PF-W08	MO-003		
PF-499	MH-008	PF-W09	MO-004		

# CROSS REFERENCE LIST

## JURID N<sup>R</sup> TO AISIN N<sup>R</sup>

JURID N <sup>R</sup>	AISIN N <sup>R</sup>	JURID N <sup>R</sup>	AISIN N <sup>R</sup>	JURID N <sup>R</sup>	AISIN N <sup>R</sup>
571941J	D2N040	572238J	C1N013	572370J	D1N034
571943J	D2N040	572245J	A2N012	572373J	B1N011
571977D	C2N022	572247J	H1N007	572375J	D1N011
572100J	E1N013	572253J	A1N023	572376J	B2N022
572110J	B2N022	572255J	A1N034	572378J	A1N049
572129J	B2N008	572256J	A1N038	572381J	D1N035
572134J	C2N022	572264J	A2N080	572393J	C1N018
572135J	C2N022	572275J	F1N010	572398J	B2N029
572136J	C2N022	572281J	D1N033	572399J	H1N016
572138J	C2N015	572287J	C1N033	572404J	A1N067
572140J	A1N021	572288J	C1N033	572405J	A1N068
572145J	E1N014	572295J	D1N014	572419J	D1N042
572146J	E1N016	572304J	A1N078	572420J	H1N001
572153J	B2N045	572309J	C1N013	572423J	F1N013
572159J	D2N028	572312J	B1N003	572424J	F2N015
572161J	E2N027	572313J	B1N003	572434J	E1N026
572162J	E2N032	572317J	E1N035	572437J	E1N003
572163J	G2N010	572324J	C1N020	572448J	B1N018
572166J	H1N004	572325J	E1N026	572450J	A2N007
572169J	E2N033	572327J	A1N043	572468J	A1N034
572178J	A1N017	572331J	E1N008	572471J	G1N006
572182J	A2N075	572332J	E1N009	572488J	A2N031
572186J	D2N032	572333J	A1N048	572490J	E2N033
572188J	A2N081	572339J	B1N020	572493J	D2N036
572189J	B1N012	572340J	C1N016	572497J	D1N003
572193J	E2N033	572342J	A1N085	572499J	D1N021
572197J	F2N012	572346J	B1N019	572501J	B2N064
572200J	D2N037	572349J	C1N034	572515J	A1N056
572206J	B1N009	572350J	C1N023	572519J	D2N022
572214J	A1N034	572354J	C1N018	572542J	B1N025
572226J	H1N011	572357J	A1N053	572547J	D2N049
572234J	B2N050	572361J	B1N011	572566J	F1N014
572237J	C1N004	572367J	A1N036		

# CROSS REFERENCE LIST

## KASHIYAMA N<sup>R</sup> TO AISIN N<sup>R</sup>

KASHIYAMA N <sup>R</sup>	AISIN N <sup>R</sup>	KASHIYAMA N <sup>R</sup>	AISIN N <sup>R</sup>	KASHIYAMA N <sup>R</sup>	AISIN N <sup>R</sup>
D0021-02	G2N010	D2105-02	A2N047	D3098-02	E1N038
D0034-02	G1N018	D2106M-02	A1N085	D3109-02	E1N003
D1025-02	B1N003	D2108-02	A1N053	D3111-02	E2N043
D1031M-02	B1N004	D2112M-02	A2N084	D3131	E2N048
D1033M-02	B2N016	D2114M-02	A2N094	D5011-02	C1N004
D1035M-02	B1N009	D2118M-02	A1N048	D5022M-02	C1N033
D1047M-02	B2N045	D2123-02	A2N058	D5027M-02	C1N013
D1063M-02	B1N011	D2125M-02	A2N059	D5042M-02	C2N022
D1092M-02	B1N020	D2126M-02	A1N056	D5050M-02	C1N013
D1099M-02	B2N016	D2129-02	A1N055	D5056M-02	C2N015
D1102M-02	B2N050	D2131M-02	A2N057	D5060M-02	C1N018
D1110M-02	B1N019	D2136M-02	A1N028	D5066M-02	C2N015
D1116M-02	B1N018	D2138M-02	A1N093	D5070M-02	C1N016
D1124M-02	B2N053	D2146M-02	A2N027	D5073M-02	C1N020
D1133M-02	B1N017	D2150M-02	A1N096	D5080M-02	C1N034
D1145M-02	B2N056	D2154-02	A1N025	D6012-02	D2N028
D1148M-02	B2N022	D2160M-02	A1N029	D6018M-02	D1N033
D1167M-02	B2N057	D2163-02	A2N030	D6024M-02	D2N032
D1181M-02	B2N026	D2165M-02	A2N095	D6039M-02	D1N034
D1205M-02	B2N029	D2166-02	A1N097	D6043M-02	D1N035
D1211M-02	B1N062	D2173M-02	A2N099	D6049M-02	D2N036
D1239M-02	B2N040	D2174M-02	A1N067	D6054M-02	D2N037
D1244M	B2N064	D2179-02	A2N004	D6066-02	D1N013
D2018-02	A1N016	D2180-02	A1N065	D6067M-02	D2N040
D2020-02	A1N017	D2183M-02	A1N068	D6070-02	D1N014
D2023-02	A1N034	D2187-02	A2N066	D6071-02	D1N038
D2028-02	A2N076	D2188M-02	A2N031	D6073M-02	D2N012
D2050M-02	A1N078	D2197-02	A1N101	D6081-02	D1N042
D2052-02	A1N061	D2198M-02	A2N069	D6085-02	D1N003
D2053M-02	A2N081	D2204M-02	A2N007	D6086M-02	D2N022
D2062-02	A2N080	D2213-02	A2N010	D6089-02	D1N021
D2065-02	A1N038	D2217-02	A1N105	D6124	D2N049
D2066-02	A2N040	D2219-02	A2N104	D7017M-02	F1N011
D2067-02	A1N019	D2243M	A2N118	D7020M-02	F2N012
D2069-02	A1N036	D2250	A2N111	D7036-02	F1N013
D2077M-02	A1N083	D2281	A2N159	D7039M-02	F1N014
D2082M-02	A1N021	D3025-02	E1N008	D7042M-02	F2N015
D2086-02	A1N049	D3027-02	E2N033	D7059	F2N016
D2087-02	A1N020	D3031-02	E2N032	D9000-02	H1N011
D2088-02	A1N041	D3047M-02	E1N009	D9013-02	H1N005
D2089-02	A2N042	D3053M-02	E1N035	D9017-02	H1N006
D2090-02	A2N012	D3062M-02	E1N014	D9024-02	H1N001
D2092-02	A1N043	D3066M-02	E1N016	D9025-02	H1N016
D2094M-02	A1N023	D3084M-02	E1N026	D9026-02	H1N020
D2099M-02	A2N044	D3094M-02	E2N030		
D2104-02	A1N050	D3097-02	E2N029		

# CROSS REFERENCE LIST

## MINTEX N<sup>R</sup> TO AISIN N<sup>R</sup>

MINTEX N <sup>R</sup>	AISIN N <sup>R</sup>	MINTEX N <sup>R</sup>	AISIN N <sup>R</sup>	MINTEX N <sup>R</sup>	AISIN N <sup>R</sup>
MDB1139	A1N017	MDB1496	F1N010	MDB1726	D1N035
MDB1144	A1N049	MDB1497	F2N012	MDB1740	H1N016
MDB1189	H1N007	MDB1501	B2N022	MDB1750	H1N001
MDB1193	A1N034	MDB1504	A1N043	MDB1756	E1N038
MDB1207	B1N009	MDB1509	D1N035	MDB1758	D2N012
MDB1220	B2N008	MDB1510	C1N014	MDB1761	H1N006
MDB1241	C1N004	MDB1514	A1N036	MDB1794	F1N013
MDB1243	C1N004	MDB1530	E1N014	MDB1823	D1N042
MDB1251	A1N043	MDB1533	C1N034	MDB1832	B2N029
MDB1252	A1N034	MDB1534	C1N014	MDB1838	A1N028
MDB1279	B1N003	MDB1535	A1N049	MDB1840	A1N055
MDB1280	B1N003	MDB1539	D1N034	MDB1845	D1N003
MDB1295	B2N016	MDB1543	C1N018	MDB1866	C2N015
MDB1297	A1N091	MDB1545	A1N085	MDB1897	A1N034
MDB1313	D2N028	MDB1546	A1N085	MDB1902	B1N018
MDB1318	H1N011	MDB1564	C2N015	MDB1906	A1N005
MDB1334	A1N036	MDB1575	E1N016	MDB1909	A1N096
MDB1344	C1N033	MDB1576	B2N045	MDB1910	G1N018
MDB1346	E1N008	MDB1577	A1N020	MDB1917	F1N014
MDB1350	E2N033	MDB1578	A1N041	MDB1921	A1N101
MDB1358	E2N032	MDB1589	C1N013	MDB1929	B2N057
MDB1360	C2N022	MDB1590	B1N054	MDB1942	A1N025
MDB1372	B1N011	MDB1609	A1N019	MDB1945	H1N020
MDB1380	B1N004	MDB1610	C1N016	MDB1946	E1N003
MDB1381	B1N009	MDB1615	C1N020	MDB1947	A1N029
MDB1395	E1N013	MDB1616	C2N022	MDB1965	D2N022
MDB1398	A1N050	MDB1635	C1N023	MDB1975	B1N062
MDB1400	A1N038	MDB1646	D2N037	MDB1987	G1N006
MDB1406	A1N038	MDB1647	A1N021	MDB1996	D1N021
MDB1411	C2N022	MDB1658	A1N048	MDB1999	F2N015
MDB1414	G2N010	MDB1661	B2N050	MDB2006	A1N067
MDB1417	B1N020	MDB1679	H1N005	MDB2013	A1N068
MDB1431	C1N036	MDB1680	E2N027	MDB2029	A1N068
MDB1439	E1N009	MDB1684	A1N053	MDB2144	B1N025
MDB1441	E1N035	MDB1688	F1N011	MDB2250	E2N043
MDB1446	D1N033	MDB1690	H1N007	MDB2261	B2N064
MDB1451	B1N019	MDB1691	D2N040	MDB2266	A1N105
MDB1464	H1N004	MDB1693	D2N036	MDB2291	A1N065
MDB1465	A1N093	MDB1695	A1N023	MDB2309	E2N033
MDB1475	B1N012	MDB1705	E2N029	MDB2351	B1N020
MDB1476	E2N036	MDB1707	B2N022	MDB2577	F2N016
MDB1481	D2N032	MDB1708	A1N056	MDB2612	D2N049
MDB1482	B1N011	MDB1712	E1N016	MDB2666	E2N048
MDB1495	D1N011	MDB1722	D1N014	MDB2757	E1N026



# CROSS REFERENCE LIST

## NISSHINBO N<sup>R</sup> TO AISIN N<sup>R</sup>

NISSHINBO N <sup>R</sup>	AISIN N <sup>R</sup>	NISSHINBO N <sup>R</sup>	AISIN N <sup>R</sup>	NISSHINBO N <sup>R</sup>	AISIN N <sup>R</sup>
PF1071	A1N016	PF1424	A2N031	PF3286	D1N013
PF1077C	A1N034	PF1430	A1N065	PF3314	D2N040
PF1086	A1N017	PF1431	A2N066	PF3338	D2N012
PF1099	A1N061	PF1432	A1N067	PF3347	D1N038
PF1109	A2N076	PF1448	A1N101	PF3369	D1N042
PF1136	A2N095	PF1449	A2N069	PF3391	D2N022
PF1142C	A2N080	PF1454	A2N007	PF3414	D1N003
PF1157	A1N019	PF1456	A2N010	PF3417	D1N021
PF1161	A2N081	PF1458	A2N104	PF3502	D2N049
PF1178	A2N040	PF1470	A1N105	PF5194	E1N035
PF1209	A1N036	PF1472	A1N068	PF5198	G2N010
PF1216	A1N078	PF1494	A2N118	PF5203	E2N033
PF1218	A1N083	PF1498	A2N111	PF5211	E1N008
PF1219	A1N021	PF1542	A2N159	PF5230	E1N016
PF1227	A1N049	PF2095	B1N003	PF5232	E1N014
PF1228	A1N041	PF2105	B1N004	PF5239	E1N026
PF1237	A1N050	PF2108	B1N009	PF5333	E2N029
PF1242	A1N023	PF2137	B1N011	PF5334	E1N038
PF1243	A2N012	PF2176	B1N020	PF5365	E2N030
PF1246	A1N020	PF2199	B1N018	PF5425	E1N003
PF1252	A2N042	PF2200	B2N045	PF5476	E2N043
PF1256	A1N043	PF2201A	B1N019	PF6353	E2N032
PF1267	A1N053	PF2221	B2N053	PF6427	G1N018
PF1273	A1N085	PF2224	B2N022	PF7247	F1N011
PF1274	A2N047	PF2226	B1N017	PF7249	F2N012
PF1276	A2N044	PF2262	B2N057	PF7390	F1N013
PF1281	A1N038	PF2270	B2N056	PF7398	F1N014
PF1321	A2N094	PF2277	B2N026	PF7415	F2N015
PF1322	A1N048	PF2304	B2N050	PF8090	C1N004
PF1323	A2N057	PF2343	B1N011	PF8127	C1N033
PF1324	A1N056	PF2357	B2N029	PF8162	C1N013
PF1325	A1N055	PF2377	B2N016	PF8254	C1N018
PF1326	A2N058	PF2389	B1N062	PF8255	C2N015
PF1360	A1N028	PF2466	B2N064	PF8264	C1N016
PF1361	A2N027	PF2467	B2N040	PF8265	C1N020
PF1363	A2N084	PF3110	D2N028	PF8266	C2N022
PF1370	A1N025	PF3172	D1N033	PF8374	C1N034
PF1387	A1N029	PF3174	D2N032	PF8397	C2N015
PF1399	A1N093	PF3233	D1N034	PF9118	H1N011
PF1401	A1N097	PF3234	D1N011	PF9183	H1N005
PF1404	A1N096	PF3271	D1N035	PF9381	H1N016
PF1409	A2N030	PF3272	D2N036	PF9382	H1N001
PF1412	A2N004	PF3280	D2N037	PF9406	H1N020
PF1421	A2N099	PF3285	D1N014	PF9408	H1N006

# CROSS REFERENCE LIST

## PAGID N<sup>R</sup> TO AISIN N<sup>R</sup>

PAGID N <sup>R</sup>	AISIN N <sup>R</sup>	PAGID N <sup>R</sup>	AISIN N <sup>R</sup>	PAGID N <sup>R</sup>	AISIN N <sup>R</sup>
T0004	B1N003	T1263	C2N015	T3019	D2N037
T0008	C1N004	T1269	G1N006	T3021	F2N012
T0009	B1N011	T1273	B1N062	T3023	C1N034
T0025	E2N032	T1275	H1N020	T3024	C1N020
T0028	B2N016	T1289	B1N025	T3025	D1N034
T0034	C2N022	T1299	E2N029	T3027	B1N054
T0035	E1N013	T1320	F1N014	T3028	B2N022
T0036	B2N045	T1330	A1N065	T3031	D2N032
T0044	D1N033	T1334	B2N064	T3032	G2N010
T0053	E1N035	T1357	B1N012	T3035	C1N023
T0317	B1N009	T1370	B1N018	T3039	D1N035
T0331	A1N036	T1395	D2N049	T3042	D2N040
T0340	B2N008	T1426	B2N057	T3043	E2N027
T0350	H1N011	T1428	E2N033	T3052	E2N033
T0358	E1N008	T1477	H1N006	T3053	A1N041
T0360	D2N028	T1517	E2N048	T3077	F1N011
T0365	C1N033	T1557	E1N026	T3079	A1N028
T0370	C1N013	T1558	D2N012	T3084	E1N016
T0392	B1N020	T1595	F2N016	T3085	H1N016
T0397	F1N010	T3000	D1N011	T3100	E1N038
T0398	D1N035	T3006	E2N036	T3107	C2N022
T0399	E1N016	T3009	B1N019	T3109	D1N014
T1232	D2N036	T3013	A1N048	T3112	H1N001
T1244	F2N015	T3014	E1N014	T3114	B2N029
T1250	D1N003	T3016	C1N018	T3123	D1N042
T1254	D2N022	T3017	C2N015	T3124	E1N003
T1257	D1N021	T3018	C1N016	T3125	F1N013

# CROSS REFERENCE LIST

## REMSA N<sup>R</sup> TO AISIN N<sup>R</sup>

REMSA N <sup>R</sup>	AISIN N <sup>R</sup>	REMSA N <sup>R</sup>	AISIN N <sup>R</sup>	REMSA N <sup>R</sup>	AISIN N <sup>R</sup>
0034.00	D2N037	0272.00	E2N036	0416.00	E2N027
0117.02	B1N004	0275.02	D1N033	0418.02	C1N016
0130.00	A1N049	0277.10	A1N017	0419.02	C1N020
0132.00	A1N017	0289.02	H1N004	0421.00	A1N050
0133.00	A1N016	0291.02	D2N032	0424.04	A2N059
0141.24	A1N041	0293.12	B1N019	0427.00	A1N053
0151.12	B2N016	0306.22	A1N085	0429.04	A1N023
0152.12	A1N085	0306.32	A1N093	0440.02	D2N040
0167.10	A1N034	0313.02	E1N035	0456.00	A1N055
0174.02	B1N012	0315.04	A1N021	0457.00	A2N058
0179.10	E2N033	0315.14	A1N029	0460.02	D1N035
0179.30	E2N033	0316.04	A1N038	0460.12	D1N035
0179.40	E2N033	0323.02	C1N013	0474.04	A1N028
0182.02	C1N036	0324.02	C1N034	0475.04	A2N027
0184.00	B1N004	0325.02	C2N015	0479.02	E2N030
0184.02	B1N004	0325.12	C2N015	0491.00	E1N038
0187.00	A1N091	0325.32	C2N015	0583.00	D1N042
0190.00	H1N011	0325.42	C2N015	0590.02	A2N081
0191.12	F1N010	0329.00	G2N010	0595.02	H1N016
0193.00	C1N004	0332.02	A1N043	062.00	A1N085
0197.10	A1N036	0333.02	E1N016	0647.02	F1N014
0199.10	A2N080	0342.02	F2N012	065.00	A2N094
0200.00	A2N076	0351.02	C1N018	0652.00	A1N034
0201.02	A2N044	0354.02	D1N034	0655.02	F1N013
0212.12	E1N014	0356.12	D2N036	0679.00	A1N025
0213.00	E2N032	0357.00	D1N014	0699.00	E1N003
0214.04	A2N075	0357.10	D1N013	0706.00	A2N004
0214.22	A2N051	0366.00	B2N022	0707.04	A1N005
0215.00	D2N028	0366.12	B2N022	0715.00	A2N040
0228.02	C1N033	0366.22	B2N022	0743.04	A2N099
0233.00	C2N022	0367.00	A2N047	0845.01	D1N021
0233.02	C2N022	0370.00	A1N041	0876.01	B2N064
0233.42	C2N022	0376.00	A2N058	0964.12	D2N049
0236.00	B1N011	0402.02	A1N048	1040.00	A2N111
0237.02	C1N013	0402.22	A1N048	107.00	A2N076
0244.00	E1N008	0405.02	D2N032	1231.00	A2N130
0244.02	E1N009	0412.20	A1N049	423.02	A1N056
0250.01	C2N015	0413.00	A2N012	750.02	D2N022
0268.04	A1N034	0413.04	A2N012		
0271.02	E1N013	0415.04	E1N026		

# CROSS REFERENCE LIST

## ROADHOUSE N<sup>R</sup> TO AISIN N<sup>R</sup>

ROADHOUSE N <sup>R</sup>	AISIN N <sup>R</sup>	ROADHOUSE N <sup>R</sup>	AISIN N <sup>R</sup>	ROADHOUSE N <sup>R</sup>	AISIN N <sup>R</sup>
1023.14	MN-903	2184.02	B1N004	2354.02	D1N034
1023.32	MN-134	2187.00	A1N091	2356.12	D2N036
1023.35	MN-120	2190.00	H1N011	2357.00	D1N014
1023.36	MN-902	2191.12	F1N010	2357.10	D1N013
1023.38	MN-127	2193.00	C1N004	2366.00	B2N022
1515.12	AN-002	2197.10	A1N036	2366.12	B2N022
1517.16	AE-OP01	2199.10	A2N080	2366.22	B2N022
1517.24	AM-013	2200.00	A2N076	2367.00	A2N047
1517.27	AN-904	2201.02	A2N044	2370.00	A1N041
1519.17	AE-OP02	2212.12	E1N014	2376.00	A2N058
1519.30	AH-019R	2213.00	E2N032	2402.02	A1N048
1519.31	AH-019L	2214.04	A2N075	2402.22	A1N048
1519.40	AH-003L	2214.22	A2N051	2405.02	D2N032
1519.41	AH-003R	2215.00	D2N028	2412.20	A1N049
1519.51	AN-011	2228.02	C1N033	2413.00	A2N012
1520.07	AM-003L	2233.00	C2N022	2413.04	A2N012
1520.08	AM-003R	2233.02	C2N022	2415.04	E1N026
1520.09	AN-013	2233.42	C2N022	2416.00	E2N027
1520.10	AN-901L	2236.00	B1N011	2418.02	C1N016
1520.11	AN-901R	2237.02	C1N013	2419.02	C1N020
1520.81	AN-052L	2244.00	E1N008	2421.00	A1N050
1520.82	AN-052R	2244.02	E1N009	2423.02	A1N056
1522.05	AN-008	2250.01	C2N015	2424.04	A2N059
1522.06	AS-030	2268.04	A1N034	2427.00	A1N053
1522.51	AT-050	2271.02	E1N013	2429.04	A1N023
1522.65	AN-053	2272.00	E2N036	2440.02	D2N040
1523.11	AN-906	2275.02	D1N033	2456.00	A1N055
2034.00	D2N037	2277.10	A1N017	2457.00	A2N058
2062.00	A1N085	2289.02	H1N004	2460.02	D1N035
2065.00	A2N094	2291.02	D2N032	2460.12	D1N035
21040.00	A2N111	2293.12	B1N019	2474.04	A1N028
21051.02	D2N049	2306.22	A1N085	2475.04	A2N027
2107.00	A2N076	2306.32	A1N093	2479.02	E2N030
2117.02	B1N004	2313.02	E1N035	2491.00	E1N038
21231.00	A2N130	2315.04	A1N021	2583.00	D1N042
2130.00	A1N049	2315.14	A1N029	2590.02	A2N081
2132.00	A1N017	2316.04	A1N038	2595.02	H1N016
2133.00	A1N016	2323.02	C1N013	2647.02	F1N014
2141.24	A1N041	2324.02	C1N034	2652.00	A1N034
2151.12	B2N016	2325.02	C2N015	2655.02	F1N013
2152.12	A1N085	2325.12	C2N015	2679.00	A1N025
2167.10	A1N034	2325.32	C2N015	2699.00	E1N003
2174.02	B1N012	2325.42	C2N015	2706.00	A2N004
2179.10	E2N033	2329.00	G2N010	2707.04	A1N005
2179.30	E2N033	2332.02	A1N043	2715.00	A2N040
2179.40	E2N033	2333.02	E1N016	2743.04	A2N099
2182.02	C1N036	2342.02	F2N012	2845.01	D1N021
2184.00	B1N004	2351.02	C1N018	2876.01	B2N064

# CROSS REFERENCE LIST

## SUMITOMO N<sup>R</sup> TO AISIN N<sup>R</sup>

SUMITOMO N <sup>R</sup>	AISIN N <sup>R</sup>	SUMITOMO N <sup>R</sup>	AISIN N <sup>R</sup>	SUMITOMO N <sup>R</sup>	AISIN N <sup>R</sup>
SN100	A2N004	SN555P	B1N017	SN775P	D2N032
SN104	E1N003	SN558P	B1N018	SN776P	D1N033
SN106P	A2N007	SN559P	B1N019	SN784P	E1N035
SN107	D1N003	SN560P	B1N020	SN789P	B2N050
SN113E	A2N010	SN564P	B2N022	SN795P	F1N011
SN120	A2N012	SN570P	B2N026	SN796P	F2N012
SN126P	A2N118	SN573P	B2N029	SN797P	B2N053
SN140	A2N159	SN594P	B2N040	SN799P	D1N034
SN225	B1N003	SN598P	C2N061	SN801P	D1N035
SN225P	B1N004	SN606	A1N034	SN804P	D2N036
SN229	A1N016	SN610P	A1N036	SN806P	D2N037
SN236	E1N008	SN611	H1N011	SN811P	B2N056
SN236P	E1N009	SN617P	A1N038	SN812P	B2N057
SN237	A1N017	SN619	A2N040	SN814E	D1N038
SN249	A1N019	SN630	G2N010	SN815P	A1N083
SN251	A1N020	SN631	A1N041	SN817P	A2N084
SN252P	E1N014	SN632	A2N042	SN818P	D2N040
SN253P	A1N021	SN635	A1N043	SN820P	A1N085
SN256P	E1N016	SN637P	A2N044	SN833P	A1N093
SN259	A2N012	SN642P	E1N026	SN837P	A2N094
SN260	D1N011	SN644	A2N047	SN840	D1N042
SN265P	A1N023	SN645P	A1N048	SN844P	A2N095
SN269P	D2N012	SN646	A1N049	SN846	E1N038
SN277	D1N013	SN647	A1N050	SN849P	A1N096
SN278	D1N014	SN651P	H1N016	SN850	A1N097
SN286E	A1N025	SN653P	A1N053	SN852P	C1N034
SN289P	A2N027	SN659E	A1N055	SN854P	A2N099
SN290P	A1N028	SN659P	A1N056	SN855	F1N013
SN291P	H1N001	SN660P	A2N057	SN856	F1N014
SN292P	A1N029	SN661E	A2N058	SN859P	B1N062
SN293	A2N030	SN661P	A2N059	SN860	H1N020
SN294P	A2N031	SN663	A1N061	SN866	F2N015
SN296	D1N021	SN668	E2N029	SN871	G1N018
SN298P	D2N022	SN671	A1N065	SN877	A1N101
SN403	C1N004	SN672	A2N066	SN883	E2N043
SN416P	C1N013	SN679P	A2N069	SN885	A2N104
SN419P	C2N015	SN685P	A1N067	SN890	A1N105
SN421P	C1N016	SN686P	A1N068	SN891P	B2N064
SN423P	C1N018	SN742	E2N032	SN908	A2N111
SN425P	C1N020	SN745	D2N028	SN912	F2N016
SN426P	C2N015	SN746P	B2N045	SN922P	E2N048
SN427P	C2N022	SN753	A2N076	SN931	E1N066
SN532P	B1N009	SN758P	A1N078	SN944P	E1N068
SN536P	B1N011	SN764	A2N080	SN930	E2N065
SN551P	B2N016	SN765P	C1N033	SN945	E2N067
SN553	H1N005	SN771P	A2N081	SN954P	H1N041
SN554	H1N006	SN773	E2N033		

# CROSS REFERENCE LIST

## TEXTAR N<sup>R</sup> TO AISIN N<sup>R</sup>

TEXTAR N <sup>R</sup>	AISIN N <sup>R</sup>	TEXTAR N <sup>R</sup>	AISIN N <sup>R</sup>	TEXTAR N <sup>R</sup>	AISIN N <sup>R</sup>
2000201	E1N008	2155801	E2N036	2329501	E1N016
2000801	E2N032	2155901	G2N010	2330301	H1N006
2003101	E2N033	2156101	B1N019	2331401	H1N001
2009902	C1N033	2157101	E1N038	2336701	B2N057
2095702	B1N012	2160101	A1N048	2337301	D2N036
2095802	B1N009	2164701	D1N035	2338704	E2N029
2095901	C1N004	2165001	D1N014	2340001	H1N016
2095902	C1N004	2165101	C1N018	2342001	B1N062
2109901	B1N003	2165404	E1N014	2348701	D1N021
2109902	B1N003	2169401	C1N016	2348801	D1N003
2112102	B2N016	2169701	C1N020	2349002	E1N003
2112201	B2N008	2170001	C1N014	2349201	D2N012
2112503	D2N028	2170301	F2N012	2350701	G1N006
2114202	H1N011	2170602	D2N032	2355802	F1N013
2115801	A1N036	2171301	B2N022	2357202	F2N015
2131201	C2N022	2171602	B1N054	2359301	D2N022
2134101	B2N045	2171901	C2N015	2361101	B1N018
2134702	B1N011	2173801	C2N022	2365201	C2N015
2135501	E1N013	2176603	E2N027	2366201	H1N020
2136301	D1N034	2179101	A1N041	2378001	F1N014
2137301	D1N033	2184002	D2N037	2384504	E1N026
2137801	E1N035	2187202	D2N040	2386401	A1N065
2144601	C1N013	2187901	C1N023	2387101	B2N064
2148201	F1N011	2195701	A1N028	2401401	D2N049
2149501	F1N010	2300501	B1N025	2404501	E2N033
2149701	C1N034	2302301	B2N029	2421501	E2N048
2152601	B1N020	2308001	D1N035	2433101	F2N016
2153901	E1N016	2329002	D1N042		

# CROSS REFERENCE LIST

## TOKICO N<sup>R</sup> TO AISIN N<sup>R</sup>

TOKICO N <sup>R</sup>	AISIN N <sup>R</sup>	TOKICO N <sup>R</sup>	AISIN N <sup>R</sup>	TOKICO N <sup>R</sup>	AISIN N <sup>R</sup>
T1124	A2N076	TN255M	C2N015	TN504	H1N006
T1251M	A1N083	TN257	A2N012	TN509	D1N038
T1290	A1N061	TN262M	F1N011	TN511M	E1N026
TN074	A1N016	TN263M	F2N012	TN514	D1N042
TN086M	B1N009	TN266M	C1N018	TN523M	A1N029
TN089	C1N004	TN267M	D2N037	TN525M	B1N062
TN101M	A1N034	TN271	A2N080	TN527	A1N097
TN1124	A2N076	TN272M	B2N050	TN528	A2N030
TN115	B1N003	TN274	D1N014	TN529M	B1N019
TN115M	B1N004	TN277	A1N041	TN531M	E1N016
TN117M	A1N078	TN278	A2N042	TN537M	B2N016
TN121	A1N017	TN280M	D2N036	TN538	F1N014
TN127	D2N028	TN281	G2N010	TN539	F1N013
TN128	E1N008	TN291	A1N050	TN540M	A1N096
TN129	H1N011	TN406M	B2N056	TN542	D1N021
TN146M	B2N016	TN407	A2N047	TN543	H1N020
TN157	E2N032	TN410M	C2N015	TN544M	E1N026
TN163M	B1N011	TN413M	A1N048	TN552	A1N101
TN167M	C1N033	TN417M	B2N057	TN553	E2N043
TN170	E2N033	TN418	A1N053	TN559	F2N015
TN176M	A2N081	TN419M	C1N016	TN560M	A2N095
TN189	A1N038	TN420M	C1N020	TN562M	A2N099
TN190M	E1N009	TN422M	A1N085	TN564M	A2N031
TN193	A2N040	TN430M	A2N094	TN565	D1N003
TN197M	D1N033	TN432M	B2N026	TN571	A2N004
TN199M	D2N032	TN435M	A2N057	TN572	E1N003
TN210M	E1N035	TN441M	D2N040	TN573	A1N065
TN212	A1N019	TN443	D1N013	TN575	G1N018
TN213M	B1N020	TN444M	C2N022	TN580M	D2N022
TN215	A1N036	TN445M	A2N084	TN585M	A1N067
TN218M	B1N018	TN447M	C1N034	TN589	A2N066
TN222	H1N005	TN453	A2N058	TN593M	A2N044
TN223	A1N020	TN459M	A1N093	TN600M	A1N068
TN224M	C1N013	TN463	A1N055	TN606M	A2N069
TN231M	B2N053	TN465M	A1N028	TN614	A2N104
TN236M	B2N045	TN467	E2N029	TN616	A1N105
TN237M	E1N014	TN468	E1N038	TN618M	B2N040
TN238M	D1N035	TN469M	A1N056	TN632	A2N010
TN242M	B1N017	TN474	A1N025	TN639	D2N049
TN243M	B2N022	TN475M	E2N030	TN647M	B2N064
TN244	A1N043	TN478M	B2N029	TN653M	A2N007
TN245M	D1N034	TN494M	A2N027	TN672	E2N048
TN248M	A1N023	TN500	H1N001	TN679	F2N016
TN252M	A1N021	TN501	H1N016	TN694	A2N111
TN253	A1N049	TN503M	D2N012		



# CROSS REFERENCE LIST

## TRW N<sup>R</sup> TO AISIN N<sup>R</sup>

TRW N <sup>R</sup>	AISIN N <sup>R</sup>	TRW N <sup>R</sup>	AISIN N <sup>R</sup>	TRW N <sup>R</sup>	AISIN N <sup>R</sup>
BWA107	AD-004	BWC178	WCT-002	BWD234	AN-010
BWA114	AF-003	BWC179	WCT-001	BWD235	AF-006
BWA123	AF-008	BWC180	AM-009	BWD236	AN-041
BWA133	AD-029R	BWC181	AZ-007L	BWD239	WCT-018
BWA134	AD-029L	BWC184	AZ-009	BWD240	WCT-021
BWA137	AO-002	BWC186	AZ-009	BWD241	AS-016L
BWA138	AO-001	BWC187	AN-904	BWD242	AS-016R
BWA139	WCT-103	BWC189	AZ-035	BWD245	AH-003R
BWA142	WCT-184	BWC203	AD-010L	BWD248	47550-20141
BWA143	WCT-121	BWC204	AD-010R	BWD263	AH-012
BWA144	AH-015R	BWC205	AM-013	BWD264	AH-008
BWA145	AH-015L	BWC207	AZ-006L	BWD265	AH-003L
BWA154	WCT-074	BWC208	AZ-006R	BWD266	WCT-014
BWA155	WCT-069	BWC214	AZ-023L	BWD267	WCT-015
BWA156	AD-030	BWC220	47570-16040	BWD270	AT-046L
BWA157	AY-017L	BWC221	WCT-022	BWD271	AT-046R
BWA160	AZ-034	BWC223	AS-022R	BWD285	AS-018R
BWA161	AY-016L	BWC224	AS-022L	BWD286	AS-018L
BWB120	AF-004	BWC225	AZ-023R	BWD287	AE-RO02L
BWB128	AN-027	BWC229	WCT-039	BWD288	AE-RO02R
BWB129	47550-16011	BWC230	AF-009	BWD290	WCT-122
BWB130	AN-002	BWC231	AS-027R	BWD292	AY-004L
BWB132	AS-014	BWC232	AS-027L	BWD293	AY-004R
BWB133	AS-029R	BWC234	AD-027	BWD296	AZ-024
BWB134	AS-029L	BWC236	AD-031L	BWD297	AF-010
BWB135	AN-005	BWC244	AH-017	BWD308	WCT-070
BWB136	AN-050	BWC245	AY-012L	BWD309	WCT-075
BWB138	AS-008	BWC249	WCT-072	BWD310	AT-049
BWB139	AN-011	BWC250	WCT-076	BWD311	AM-019
BWB147	WCT-048	BWC251	AO-001	BWD312	AZ-036
BWB168	AY-003R	BWC253	AH-018	BWD313	AN-051
BWB169	AY-003L	BWD119	AE-OP02	BWD318	AZ-037
BWB172	AT-048L	BWD139	AF-002	BWD321	AO-003
BWB173	AT-048R	BWD140	AS-023	BWD328	AY-020L
BWC106	43300-634-670	BWD141	AM-005	BWD329	AY-020R
BWC115	AE-OP01	BWD168	AM-017	BWD332	WCT-071
BWC124	AZ-012	BWD175	AM-006R	BWD333	WCT-073
BWC125	AZ-013	BWD188	AH-019L	BWD335	AZ-038
BWC129	AF-005	BWD189	AH-019R	BWF160	AN-901L
BWC132	AZ-007R	BWD195	AE-FO01	BWF161	AN-901R
BWC134	AS-015	BWD197	WCT-010	BWF162	AN-052L
BWC136	AF-001	BWD200	47550-35160	BWF163	AN-052R
BWC137	AN-016	BWD201	AM-006L	BWF181	AM-002R
BWC138	AN-009	BWD205	AZ-014	BWF198	47550-12060
BWC142	AD-006R	BWD206	AZ-019L	BWF201	AM-002L
BWC143	AD-006L	BWD207	AZ-019R	BWF205	AN-013
BWC144	AH-016R	BWD210	WCT-017	BWF209	WCT-013
BWC145	AD-012L	BWD211	AM-004	BWF215	AZ-016R
BWC146	AD-012R	BWD217	AH-001L	BWF216	AZ-016L
BWC165	AN-014L	BWD218	AH-001R	BWF220	AZ-011L
BWC166	AN-014R	BWD220	AH-006	BWF221	AZ-011R
BWC167	AH-007	BWD221	AZ-015L	BWF222	WCT-024
BWC168	AH-009	BWD222	AZ-015R	BWF226	AM-003L
BWC171	AH-005L	BWD225	AN-044	BWF227	AM-003R
BWC172	AH-005R	BWD226	AZ-003	BWF230	WCT-019
BWC173	AZ-005	BWD227	WCT-009	BWF232	AH-004
BWC174	AN-017	BWD228	47550-20130	BWF236	AM-007
BWC175	AN-012	BWD229	AH-002L	BWF238	AY-001
BWC176	AN-026	BWD230	AH-002R	BWF239	AY-001

# CROSS REFERENCE LIST

## TRW N<sup>R</sup> TO AISIN N<sup>R</sup>

TRW N <sup>R</sup>	AISIN N <sup>R</sup>	TRW N <sup>R</sup>	AISIN N <sup>R</sup>	TRW N <sup>R</sup>	AISIN N <sup>R</sup>
BWF241	AN-003	BWK156	AN-906	GDB1183	C1N016
BWF242	AH-010	BWK160	AM-010L	GDB1184	A1N056
BWF247	AY-001	BWK161	AM-010R	GDB1185	A2N059
BWF249	AY-001	BWK180	AS-005L	GDB1195	A1N085
BWF255	WCT-036	BWK181	AS-005R	GDB1197	D1N035
BWF256	WCT-038	BWK215	47550-28031	GDB1205	E2N036
BWF266	47550-32030	BWK225	AN-052	GDB1240	A2N031
BWF272	AT-045L	BWL121	AN-007	GDB1241	A1N055
BWF273	AT-045R	BWL178	AS-003R	GDB1257	A2N058
BWF292	AT-047R	BWL179	AS-003L	GDB1286	D1N042
BWF293	AY-006R	BWL180	AS-002R	GDB233	A1N049
BWF294	AY-006L	BWL181	AS-002L	GDB293	A1N016
BWF296	AN-903	BWL183	AS-017FU	GDB3044	D2N036
BWF297	AN-902L	BWL184	AS-017RFD	GDB3045	D2N040
BWF298	AN-902R	BWL185	AS-017LFD	GDB3058	A2N044
BWF325	AM-012	BWL186	AG-001	GDB3086	A1N093
BWF326	AM-020	BWL190	AS-010RD	GDB3091	H1N016
BWH261	WCT-196	BWL191	AS-010LD	GDB3104	D2N012
BWH263	WCT-008	BWL192	AS-010RU	GDB3105	A2N027
BWH264	WCT-203	BWL193	AS-010LU	GDB3108	H1N005
BWH265	WCT-209	BWL195	AN-053	GDB3109	A1N049
BWH266	WCT-005	BWL203	WCT-011	GDB3110	A2N012
BWH270	AN-008	BWL291	AT-051	GDB3115	B2N029
BWH277	AN-001	BWN153	WCT-035	GDB3124	B1N025
BWH278	AS-020R	BWN157	47550-60130	GDB3129	E2N030
BWH279	AS-020L	BWN158	AN-054	GDB3130	A1N083
BWH287	AG-002LR	BWN187	WCT-166	GDB3132	H1N001
BWH288	AS-009L	BWN188	WCT-158	GDB3152	A1N101
BWH289	AS-009R	BWN334	AT-024LFB	GDB3153	E1N016
BWH290	AS-006L	BWN335	AT-024RFA	GDB3154	C2N015
BWH291	AS-001L	BWN336	47530-60080	GDB3157	A1N096
BWH292	AS-001R	BWN337	AT-024RFB	GDB3160	C2N022
BWH295	WCT-004	GDB1002	B2N045	GDB3167	B1N062
BWH296	AN-020	GDB1003	B1N019	GDB3175	C2N015
BWH298	AS-030	GDB1004	B1N012	GDB318	B1N003
BWH300	AT-050	GDB1017	B1N011	GDB3184	A1N034
BWH301	AN-907	GDB1020	B1N004	GDB3193	E1N003
BWH302	AN-053	GDB1023	D2N032	GDB3197	A1N005
BWH307	AD-032L	GDB1024	E1N014	GDB3198	A2N004
BWH308	AD-032R	GDB1026	A1N020	GDB3204	A1N034
BWH309	AM-001L	GDB1027	E2N033	GDB3205	F1N014
BWH310	WCT-027	GDB1029	E1N016	GDB3209	E1N026
BWH312	AM-001R	GDB1043	A1N085	GDB3210	H1N011
BWH319	AS-006R	GDB1061	C1N023	GDB3214	D1N014
BWH343	AN-054	GDB1063	C2N015	GDB3217	F1N013
BWH344	WCT-107	GDB1126	D1N034	GDB3218	A1N067
BWH372	AM-018	GDB1127	D2N032	GDB3220	G1N018
BWH380	47550-35190	GDB1128	D1N035	GDB3221	H1N020
BWH389	AS-025	GDB1138	A2N047	GDB3225	A2N040
BWH390	AS-026	GDB1140	E2N027	GDB3226	A1N025
BWH405	AS-031R	GDB1142	A1N041	GDB323	A1N034
BWH406	AS-031L	GDB1143	A1N048	GDB3230	E1N038
BWK140	WCT-003	GDB1145	A1N053	GDB3233	A2N099
BWK142	AH-011LFA	GDB1154	A1N023	GDB3234	H1N006
BWK143	AH-011LFB	GDB1164	C1N020	GDB3236	G1N006
BWK144	AH-011RFA	GDB1168	A1N028	GDB3239	D2N022
BWK152	AN-004	GDB1172	B2N022	GDB3242	A1N068
BWK154	AS-007R	GDB1174	H1N007	GDB3243	A2N007
BWK155	AS-007L	GDB1176	D1N003	GDB3246	D1N003

# CROSS REFERENCE LIST

## TRW N<sup>R</sup> TO AISIN N<sup>R</sup>

TRW N <sup>R</sup>	AISIN N <sup>R</sup>	TRW N <sup>R</sup>	AISIN N <sup>R</sup>	TRW N <sup>R</sup>	AISIN N <sup>R</sup>
GDB325	C1N013	PMA161	47201-26410	PMF335	MS-014
GDB3270	D1N021	PMA164	BMT-281	PMF342	47207-16020
GDB3294	B2N064	PMA165	BMT-052	PMF343	MH-003
GDB351	A1N036	PMA166	MT-206	PMF345	47201-14211
GDB352	A1N017	PMA167	BMT-048	PMF348	MZ-088
GDB358	C1N004	PMA168	BMT-224	PMF350	47207-12020
GDB367	B1N003	PMA169	BMT-149	PMF355	BMT-076
GDB375	E2N032	PMA171	BMT-102	PMF359	MS-007
GDB384	A2N044	PMA172	MT-156	PMF362	BMS-004
GDB388	A1N091	PMA173	BMT-234	PMF363	BMS-007
GDB499	C2N022	PMA174	MT-149	PMF369	MM-067
GDB729	D1N033	PMA175	BMT-236	PMF370	MS-018
GDB730	A2N075	PMA176	BMT-258	PMF385	MH-043
GDB732	B1N009	PMA177	MH-041	PMF400	MS-005
GDB733	C1N013	PMA179	MH-032	PMF404	MS-021
GDB737	E1N009	PMA182	MH-027	PMF407	MM-068
GDB764	C1N036	PMA183	MH-037	PMF429	MN-132
GDB765	B1N020	PMA184	MH-033	PMF435	MN-104
GDB766	B1N011	PMA185	MH-042	PMF436	MN-098
GDB770	A1N050	PMA197	MH-030	PMF437	47201-27040
GDB773	E1N013	PMA208	MN-131	PMF440	MN-090
GDB774	C2N015	PMD208	MS-024	PMF452	MM-055
GDB797	A1N021	PMD266	MN-126	PMF464	MD-008
GDB798	A1N038	PMD321	47207-10020	PMF491	BMT-009
GDB868	A1N038	PMD324	MN-061	PMF497	MY-011
GDB869	A1N085	PMD326	MN-016	PMF498	MY-016
GDB872	A2N080	PMD328	MS-012	PMF500	MN-089
GDB878	A1N043	PMD334	MS-006	PMF507	MN-118
GDB884	C2N010	PMD335	MN-005	PMF508	MN-118
GDB885	H1N004	PMD339	MS-015	PMF515	MO-007
GDB887	G2N010	PMD341	MS-003	PMF516	MO-011
GDB894	C1N034	PMD342	MZ-044	PMF535	MN-133
GDB925	C1N033	PMD344	MS-010	PMF536	MS-042
GDB945	D2N028	PMD354	BMT-119	PMF537	MT-203
GDB946	A2N076	PMD364	BMT-172	PMF538	MT-204
GDB974	C2N022	PMD368	51100-82120	PMF565	BMT-024
GDB981	E1N035	PMD403	47201-16180	PMH190	MM-024
GDB983	E1N008	PMD409	MD-033	PMH191	MM-011
GDB988	B1N009	PMF106	MS-031	PMH281	MN-063
GDB989	F1N010	PMF107	MS-030	PMH298	MZ-005
GDB990	F2N012	PMF127	MS-011	PMH303	BMT-061
GDB995	C1N018	PMF211	MH-007	PMH308	MZ-004
PMA107	MN-128	PMF226	MY-003	PMH309	MM-004
PMA114	MN-088	PMF245	MH-025	PMH319	MZ-002
PMA116	MD-006	PMF270	MZ-012	PMH323	47207-32010
PMA117	MD-007	PMF271	MH-005	PMH324	MH-002
PMA119	MD-035	PMF272	47207-12020	PMH326	MG-005
PMA123	MD-004	PMF280	MZ-003	PMH327	MH-009
PMA124	MD-031	PMF290	MM-008	PMH330	MZ-033
PMA126	MD-009	PMF291	MN-015	PMH331	MG-001
PMA142	MO-022	PMF295	MH-001	PMH332	MG-004
PMA146	MO-004	PMF300	MF-008	PMH342	MZ-013
PMA147	MO-005	PMF307	MH-006	PMH343	MZ-014
PMA150	MT-104	PMF309	47201-14410	PMH351	MH-023
PMA151	47201-10180	PMF312	47201-12400	PMH362	MZ-042
PMA155	MT-147	PMF317	MF-009	PMH364	MZ-006
PMA156	MT-106	PMF318	MF-003	PMH365	MZ-017
PMA157	MT-106	PMF331	47201-14201	PMH369	MH-004
PMA160	47201-20881	PMF334	MF-002	PMH377	MZ-022

# CROSS REFERENCE LIST

## TRW N<sup>R</sup> TO AISIN N<sup>R</sup>

TRW N <sup>R</sup>	AISIN N <sup>R</sup>	TRW N <sup>R</sup>	AISIN N <sup>R</sup>	TRW N <sup>R</sup>	AISIN N <sup>R</sup>
PMH378	MZ-007	PMK283	MH-008	PML227	47201-32170
PMH395	BMT-113	PMK284	MH-018	PML228	MM-023
PMH396	MH-012	PMK285	MH-013	PML229	MM-040
PMH399	MH-004	PMK287	MZ-048	PML231	BMT-110
PMH404	MH-011	PMK290	BMT-056	PML232	BMT-099
PMH408	MZ-035	PMK292	MT-002	PML235	BMT-063
PMH409	47201-20360	PMK293	MZ-019	PML238	MT-113
PMH414	MZ-018	PMK294	MZ-055	PML240	BMT-114
PMH415	MY-001	PMK296	47201-33050	PML243	MH-029
PMH426	51100-70A00	PMK297	47201-33060	PML244	MH-021
PMH428	MT-001	PMK300	47201-20390	PML246	MT-047
PMH429	47201-28070	PMK303	MH-022	PML273	MG-018
PMH432	BMT-022	PMK304	MH-010	PML279	BMT-007
PMH434	BMT-086	PMK305	MH-020	PML280	MM-029
PMH456	BMS-010	PMK306	MH-016	PML284	47201-32070
PMH462	MD-003	PMK307	MH-019	PML307	MN-078
PMH469	MM-041	PMK313	MN-120	PML308	47201-25140
PMH470	MM-051	PMK345	MN-077	PML310	BMT-212
PMH475	MG-002	PMK346	BMT-069	PML332	MN-106
PMH494	MZ-087	PMK347	MH-045	PML348	MN-122
PMH496	MT-126	PMK354	MN-902	PML352	BMT-303
PMH497	BMT-107	PMK355	MM-045	PML353	BMT-068
PMH513	BMT-111	PMK357	47201-20550	PML354	BMT-088
PMH545	BMT-095	PMK359	MM-052	PML375	MN-103
PMH547	MM-042	PMK385	BMT-244	PML376	MN-099
PMH591	MT-005	PMK390	BMT-034	PML377	MF-011
PMH610	MM-069	PMK391	47201-3D040	PML380	BMT-004
PMH612	MN-109	PMK393	MN-094	PML402	MN-111
PMH613	MN-091	PMK404	BMT-048	PML425	ME-OP02
PMH614	MN-901	PMK410	47201-60521	PML454	MH-028
PMH627	MN-110	PMK434	MN-136	PML456	MM-072
PMH630	MN-034	PMK488	47201-20871	PML457	BMS-009
PMH633	MO-009	PMK502	MY-006	PML458	BMT-072
PMH634	MO-013	PMK503	MY-007	PML459	BMT-079
PMH635	MO-010	PMK509	MN-100	PML460	BMT-089
PMH636	MO-014	PMK513	MM-059	PML461	BMT-116
PMH725	MM-070	PMK514	MM-071	PML462	MM-073
PMK102	BMT-010	PMK515	MM-060	PML463	BMT-239
PMK104	MN-903	PMK538	ME-OP01	PMN128	MN-003
PMK107	MN-127	PMK542	MN-129	PMN130	MF-012
PMK109	MN-134	PMK543	MN-112	PMN169	BMT-005
PMK168	MM-063	PMK583	MN-137	PMN171	MT-067
PMK192	MH-044	PMK588	MY-023	PMN173	MT-069
PMK211	MN-072	PMK594	MN-119	PMN177	MT-068
PMK212	MN-019	PMK599	MN-138	PMN179	MT-066
PMK222	MM-009	PMK610	ME-CI01	PMN224	MF-014
PMK232	MN-107	PMK631	MM-056	PSA216	LS-001
PMK233	MN-060	PMK640	MF-900	PSA420	LN-001
PMK234	MM-017	PMK642	MZ-056	PSA421	LE-RO01
PMK235	MN-022	PMK644	MN-139	PSA709	LN-002
PMK237	MH-015	PML133	MM-057	PSA717	LN-003
PMK239	MM-020	PML134	MM-027	PSA718	LH-001
PMK245	MM-001	PML188	BMT-060	PSA741	LN-004
PMK248	MN-135	PML195	BMT-025	PSA943	LT-003
PMK249	MM-034	PML202	MN-012	PSA945	LT-004
PMK260	MG-013	PML222	MF-004	PSA946	LT-005
PMK265	MH-017	PML223	MF-005	PSA959	LH-002
PMK270	MM-031	PML224	MH-046	PSA962	LH-003
PMK281	MN-092	PML225	MT-007	PSA963	LH-004

# CROSS REFERENCE LIST

## TRW N<sup>R</sup> TO AISIN N<sup>R</sup>

TRW N <sup>R</sup>	AISIN N <sup>R</sup>	TRW N <sup>R</sup>	AISIN N <sup>R</sup>	TRW N <sup>R</sup>	AISIN N <sup>R</sup>
PSA964	LH-005	PSA965	LH-006	PSA966	LH-007

## Abbreviations

	English	Deutsch	Français	Portugueses	Nederlands	Russian	Italiano	Español	Polish
<b>16V</b>	16 Valves	16 Ventile	16 Soupapes	16 Válvulas	16 Kleppen	16- клапанный	16 Valvole	16 Válvulas	16 Zaworów
<b>2WD</b>	2 Wheels Drive	Zweirädersystem	2 Roues motrices	2 Rodas motrizes	2 Wiel aangedreven	Передний/задний привод	2 Ruote motrici	Traccion delantera o trasera	Naped na 2 kola
<b>4WD</b>	4 Wheels Drive	Allradantrieb	4 Roues motrices	4 Rodas motrizes	4 Wiel aangedreven	Полный привод	4 Ruote motrici	4 Por 4	Naped na 4 kola
<b>8V</b>	8 Valves	8 Ventile	8 Soupapes	8 Válvulas	8 Kleppen	8-Клапанный	8 Valvole	8 Válvulas	8 Zaworow
<b>A</b>	Front or upper	Vorne Oder Oben	Avant ou supérieur	Frente ou superior	Voor of boven	Передний или верхний	Anteriore o superiore	Delantero o superior	Przedni lub górny
<b>ABS</b>	Anti-locking Brake System	Antiblockiersystem	Système anti blocage	Sistema travão anti-bloqueio	Anti-blokeer-systeem	Абс	Freni con abs	Frenos abs	Abs
<b>ABS Fr. L</b>	ABS Sensor Front Left	Vorne links ABS sensor	Capteur d'ABS avant gauche	Sensor ABS frente esquerdo	ABS Sensor voor links	Датчик АБС передний левый	Sensore ABS anteriore sinistro	ABS sensor delantero izquierda	Czujnik ABS przedni lewy
<b>ABS Rr. L</b>	ABS Sensor Rear Left	Hinten links ABS sensor	Capteur d'ABS arrière gauche	Sensor ABS atrás esquerdo	ABS Sensor links achter	Датчик АБС задний левый	Sensore ABS posteriore sinistro	ABS sensor trasero izquierda	Czujnik ABS tylny lewy
<b>ABS Rr. R</b>	ABS Sensor Rear Right	Hinten rechts ABS sensor	Capteur d'ABS arrière droit	Sensor ABS atrás direito	ABS Sensor rechts achter	Датчик АБС задний правый	Sensore ABS posteriore destro	ABS sensor trasero derecha	Czujnik ABS tylny prawy
<b>ABS Skid</b>	ABS Skid Sensor	ABS Schleuder Sensor	Capteur ABS de dérapage	Sensor ABS de derrapagem	ABS skid sensor	Абс датчик блокировки	Sensore ABS stabilità	Sensor ABS estabilidad	Czujnik ABS antypoślizgowy
<b>B</b>	Rear or lower	Hinten Oder Niedriger	Arrière ou inférieur	Atrás ou inferior	Achter of lager	задний или нижний	Posteriore o inferiore	Trasero o inferior	Tylny lub dolny
<b>BB</b>	Brake Booster	Bremskraftverstärker	Servofrein	Servo Freio	Rembekrachtiger	Тормозной усилитель	Servofreno	Sistema de asistencia a la frenada	Wzmacniacz siły hamowania
<b>BC Fr. L</b>	Brake Caliper Front Left	Vorne Links Bremssattel	Etrier de frein avant gauche	Pinça de travão de disco frente esquerda	Voor links remzadel	суппорт тормозной передний левая сторона	Pinza freno anteriore sinistro	Pinza de freno delantero izquierda	Zacisk hamulcowy przedni lewy
<b>BC Fr. R</b>	Brake Caliper Front Right	Vorne Rechts Bremssattel	Etrier de frein avant droit	Pinça de travão de disco frente direita	Voor recht remzadel	суппорт тормозной передний правая сторона	Pinza freno anteriore destro	Pinza de freno delantero derecha	Zacisk hamulcowy przedni prawy
<b>BC Rr. L</b>	Brake Caliper Rear Left	Hinten Links Bremssattel	Etrier de frein arrière gauche	Pinça de travão de disco atrás esquerda	Achter links remzadel	суппорт тормозной задний левая сторона	Pinza freno posteriore sinistro	Pinza de freno trasero izquierda	Zacisk hamulcowy tylny lewy
<b>BC Rr. R</b>	Brake Caliper Rear Right	Hinten Rechts Bremssattel	Etrier de frein arrière droit	Pinça de travão de disco atrás direita	Achter recht remzadel	суппорт тормозной задний правая сторона	Pinza freno posteriore destro	Pinza de freno trasero derecha	Zacisk hamulcowy tylny prawy
<b>BR</b>	Birotor	Birotor	Birotor	Bi-rotor	Dubbele rotor	двухсекционный РПД	Bi-rotore	Birotor	Slinik wankla
<b>CPE</b>	Coupé	Coupé	Coupé	Coupé	Coupé	Купе	Coupé	Coupé	Coupe
<b>CTT</b>	Carburettor	Vergaser	Carburateur	Carburador	Carburator	Карбюратор	Carburatore	Carburador	Gaznik
<b>CYC</b>	Catalytic Converter	Katalysator	Catalyseur	Conversor catalítico	Katalysator	Катализатор	Convertitore catalitico	Convertidor catalítico	Katalizator
<b>DI</b>	Direct Injection	Direkt Einspritzung	Injection directe	Injección directa	Direct ingespoten (in de cilinder)	Прямой впрыск	Iniezione diretta	Inyección directa	Wtrysk bezpośredni
<b>DRT</b>	Dual Rear Tyres	Doppelbereifung	Roues arrières jumelées	Roda dupla traz	Dubbele achterwielen (bij vrachtwagens)	Задние двойные колеса	Ruote posteriori gemellate	Ruedas traseras acopladas	Z podwójnymi kołami z tyłu
<b>E/G</b>	Engine	Motor	Moteur	Motor	Motor	Двигатель	Motore	Motor	Slinik
<b>EFI</b>	Electronic Fuel Injection	Elektronische Einspritzung	Injection électronique d'essence	Injeção eletrónica combustível	Elektronische brandstof-injectie	Электронный впрыск топлива	Iniezione elettronica	Inyección electrónica	Elektroniczny wtrysk paliwa
<b>FI</b>	Fuel Injection	Einspritzung	Injection d'essence	Injeção Combustivel	Brandstof-injectie	Система впрыска топлива	Iniezione carburante	Motor a inyección	Wtrysk paliwa
<b>FWD</b>	Front Wheels Drive	Frontantrieb	Traction avant	Tracção rodas frente	Voorwielaandrijving	Передний привод	Trazione anteriore	Traccion delantera	Naped na przednie kola
<b>HBK</b>	Hatchback	Hatchback	Hayon arrière	Hatchback	Hatchback - 3deurs	Хэтчбэк	Portellone posteriore	Coupe	Hatchback
<b>LA</b>	Left side front or upper	Vorne Links Oder Oben	Avant ou supérieur gauche	Frente ou superior esquerdo	Links voor of boven	левосторонний передний или верхний	Anteriore o superiore sinistro	Delantero o superior izquierda	Lewy przedni lub górny
<b>LB</b>	Left side rear or lower	Hinten Links oder niedriger	Arrière ou inférieur gauche	Atrás ou inferior izquierdo	Links achter of onder	левосторонний задний или нижний	Posteriore o inferiore sinistro	Trasero o inferior izquierda	Lewy tylny lub dolny
<b>MPI</b>	Multi Point Injection	Mehreinspritzung	Injection multi-point	Injeção multiponto	Veelvoudige injectie	Многоточечный впрыск	Iniezione multipoint	Inyección multipunto	Wielopunktowy wtrysk paliwa
<b>OHV</b>	Over Head Valves	oben hängende Ventile	Soupapes en tête	Valvulas cabeça	Bovenliggende kleppen	Верхнее расположение клапанов	Valvole in testa	Válvulas en culata	Walek rozrządu w kadłubie
<b>P-U</b>	Pick-Up	Pritschenwagen	Pick-up	Caixa aberta	Pick-up	Пикап	Pick up	Pick-up	Pick-up
<b>RA</b>	Right side front or upper	Vorne Rechts oder oben	Avant ou supérieur droit	Frente ou superior direito	Rechts voor of boven	правосторонний передний или верхний	Anteriore o superiore destro	Delantero o superior derecha	Prawy przedni lub górny
<b>RB</b>	Right side rear or lower	Hinten Rechts oder niedriger	Arrière ou inférieur droit	Atrás ou inferior direito	Rechts of onder	правосторонний задний или нижний	Posteriore o inferiore destro	Trasero o inferior derecha	Prawy tylny lub dolny
<b>RHD</b>	Right Hand Drive	Rechts-Lenkung	Conduite à droite	Volante à direita	Rechts Besturing	Правое рулевое управление	Guida a destra	Conducción derecha	z kierownicą po prawej stronie
<b>RWD</b>	Rear Wheels Drive	Heckantrieb	Propulsion	Tracção rodas traz	Achterwielaandrijving	Задний привод	Trazione posteriore	Tracción trasera	Naped na tylne kola
<b>SDN</b>	Sedan	Limousine	Berline	Sedan	Sedan	Седан	Berlina	Berlina 4 puertas	Sedan
<b>SQ</b>	Sequential	Reihenfolge	Séquentiel	Sequencial	Sequentieel	Последовательный	Sequenziale	Secuencial	Sekwencyjna skrzynia biegów
<b>SRT</b>	Single Rear Tyres	Einzelbereifung	Roues arrières simples	Roda simples traz	Enkelvoudige achterwielen	Одинарные шины	Ruote posteriori non gemellate	Rueda trasera simple	Z pojedynczymi kołami z tyłu
<b>T</b>	Turbo	Turbo	Turbo	Turbo	Turbo	Турбо	Turbo	Turbo	Turboładowanie
<b>TC</b>	Twin Carburettor	Doppelvergaser	Double carburateur	Carburador duplo	Dubbele carburator	Двухкамерный карбюратор	Doppio carburatore	Doble carburador	Dwa gaźniki
<b>TDI</b>	Turbo Direct Injection	Turbo mit Direkteinspritzung	Turbo à injection directe	Turbo injeção directa	Tdi: turbomotor met direct ingespoten brandstofsysteem	Прямой впрыск турбо	Turbo iniezione diretta	Turbo inyección directa	Turbo diesel z wtryskiem bezpośrednim
<b>TII</b>	Turbo Indirect Injection	Turbo mit indirekte Einspritzung	Turbo à injection indirecte	Turbo injeção indirecta	Turbomotor met indirect ingespoten brandstofsysteem	Предкамерный впрыск, турбо	Turbo iniezione indiretta	Turbo inyección indirecta	Turbo diesel
<b>TT</b>	Twin Turbo	Doppelturbo	Double turbo	Duplo turbo	Twee turbo's	Двойное турбо	Doppio turbo	Doble turbo	Dwie turbosprężarki
<b>TWI</b>	Turbo With Intercooler	Turbo mit Intercooler	Turbo avec intercooler	Turbo com intercooler	Turbo met interkoeler	Турбо с интеркулером	Turbo con intercooler	Turbo con enfriador intermedio	Turbosprężarka z chłodnicą powietrza doładowującego
<b>VTEC</b>	Variable Valve Timing System	VTEC	Déphaseur d'arbre à cames	Control eletrônico abertura valvulas	Variabele klepmentiming	Система с изменяемыми фазами газораспределения	Fasatura variabile vtec	Con variador de válvulas	Zmienne fazy rozrządu
<b>VVT-I</b>	Variable Valve Timing System	VVT-I	Déphaseur d'arbre à cames	Comando variabel valvulas -inteligente	Variabele klepmentiming	Система изменения фаз ГРМ	Distribuzione a fasatura variabile vvt-i	Con variador de válvulas	Zmienne fazy rozrządu
<b>WGN</b>	Wagon	Kombi	Break	Carrinha	Stationwagen	Вагон	Wagon	Wagon	Kombi

## Fuel Codes

	English	Deutsch	Français	Portugueses	Nederlands	Russian	Italiano	Español	Polish
<b>D</b>	Diesel	Diesel	Diesel	Diesl	Diesel	дизель	Diesel	Diesel	Diesel
<b>G</b>	Gasoline	Benzin	Essence	Gasolina	Benzine	бензин	Benzina	Gasolina	Benzyna
<b>H</b>	Hybrid	Hybrid	Hybride	Hibrido	Hybrid	гибрид	Ibrido	Hibrido	Hybryda



## OUTLINE

<b>Company name</b>	AISIN SEIKI CO. LTD.	
<b>Established</b>	August 31, 1965	
<b>Capital</b>	338,49 Million €	
<b>Total sales</b>	18,45 Billion € (consolidated - Year's ended March 31st - 2010)	
<b>Employees</b>	73.213	
<b>Land area</b>	10.217.000 m <sup>2</sup>	
<b>Floor space</b>	803.000 m <sup>2</sup>	
<b>AISIN Group</b>	154 associated global subsidiaries in 20 countries	
<b>AISIN Group Plants</b>	Japan	12
	North America	19
	Central & South America	4
	Europe	5
	Asia & Oceania	15
	China	16



## Brand Protection

### “No Counterfeit Parts”

Aisin has been actively involved in preventing the manufacturing and sale of counterfeit products. In addition to our own efforts, AISIN is also participating with the “NO Counterfeit Parts” movement in conjunction with the Japan Auto Parts Industries Association (JAPIA).

Our goal is to eliminate counterfeit parts through individual and organized group efforts. If you have any information on the sale or production of counterfeit items, please contact your local representatives immediately or you may send us information directly using the Counterfeit Report Form.



### “Don’t Produce! Don’t Sell! Don’t Buy!”

Japan Auto Parts Industries Association (JAPIA) is providing a series of posters as part of the “No Counterfeit Parts” movement. To provide international awareness of illegal activities, posters are available in several key languages: English, French, Spanish, Chinese, and Arabic. Please contact your local sales representatives to receive posters and additional information. You may also apply directly using the Request Form.

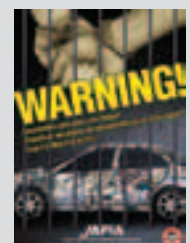



# **AISIN**

*Geared up for the future*



---

**AISIN EUROPE S.A.**  
[www.be.aisin-europe.com](http://www.be.aisin-europe.com)

Your distributor: