

AISIN

Geared up for the future



Aftermarket Products CATALOG



AISIN

One Team, Best Future

AISIN

ADVICS



Clutch Disc



Clutch Cover



Fan Clutch



Free Wheel Hub



Water Pump

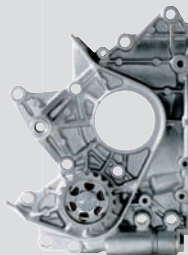

Oil Pump



Fan Blade



Hydraulic Belt Tensioner



Brake Master Cylinder



Brake Wheel Cylinder



Clutch Release Cylinder

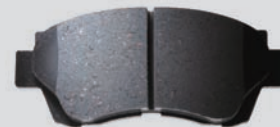

Brake Pads

Meet the AISIN Family



www.aisinaftermarket.jp

AISIN

Aftermarket Products



Brand Policy	2
Aftermarket Products Line-up	4
Products Catalog	7
	8 Clutch
	9 Water Pump
	10 Hydraulics
	11 Oil Pump
	12 ATF
	14 Fan Blade
	15 Fan Clutch
	16 Free Wheel Hub
	17 Hydraulic Belt Tensioner
	18 Timing Chain Cover
	19 Fan Pulley Bracket
	20 Flywheel Damper
Sales Office	21
Aftermarket Website	22
IMPORTANT NOTICE	23
Cross Reference List	25
	26 Fan Blade
	33 Fan Clutch
	37 Free Wheel Hub
	38 Hydraulic Belt Tensioner
	39 Timing Chain Cover
	41 Fan Pulley Bracket
	42 Flywheel Damper

Brand Promotion

40 Years as ASCO, future as AISIN

As one of the prominent leaders in Original Equipment automotive parts manufacturing, AISIN is over 53,000 employees strong in 140 associated global subsidiaries, and is the 6th ranked in the world by FOURIN's "Monthly Report on the World Automotive Industry". Developed using AISIN OE Manufacturing Technology, Aftermarket Merchandising announced the discontinuance of the ASCO brand, and as of 2005, the products will be marketed under the original AISIN name. New logos, packaging, and marketing signify a celebration of 40 years and commemorate a new outlook into the future.

Proactive Supplier of Value

If AISIN Aftermarket were a person, its character would be summed up in the phrase of "Proactive Supplier of Value". With a constantly autonomous and active stance, this personality is based on the essence of two important aspects: "a proactive supplier that appeals to the customer and market" and "that provides not only "things" to customers, but value that goes along with the products and service".



Brand Protection

"No Counterfeit Parts"

AISIN has been actively involved in preventing the manufacturing and sale of counterfeit products. In addition to our own efforts, AISIN is also participating with the "NO Counterfeit Parts" movement in conjunction with the Japan Auto Parts Industries Association (JAPIA).

Our goal is to eliminate counterfeit parts through individual and organized group efforts. If you have any information on the sale or production of counterfeit items, please contact your local representatives immediately or you may send us information directly using the Counterfeit Report Form.



Design of the AISIN Logo

The initial letter "A" in AISIN is the first letter of the alphabet, and it often expresses leadership and superiority. AISIN's advanced originality is expressed by the open shape of the "A," which symbolizes open mindedness.



"Geared up for the future"

We pursue advanced technology and improved quality, envisioning the future for people, automobiles, and the world. Through the creation of one-of-a-kind products, we are pioneers in new value, delivering innovations that are ahead of their times, one after another.

"Quality First"

Since our very beginning, Aisin Seiki has been built on a long-standing dedication to "quality first." It's a principle that defines the organization, from product development and assurance through customer satisfaction, the environment and our sense of social responsibility and contribution.



"Don't Produce! Don't Sell! Don't Buy!"

Japan Auto Parts Industries Association (JAPIA) is providing a series of posters as part of the "No Counterfeit Parts" movement. To provide international awareness of illegal activities, posters are available in several key languages: English, French, Spanish, Chinese, and Arabic. Please contact your local sales representatives to receive posters and additional information. You may also apply directly using the Request Form.



Drivetrain related

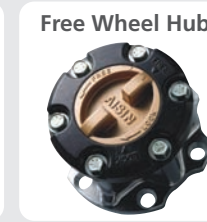

Engine related

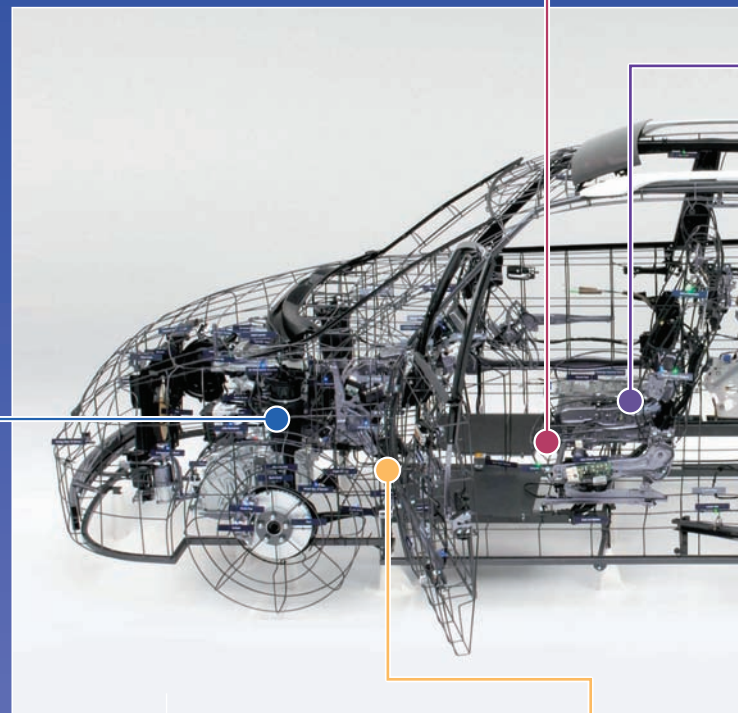

Brake related



Line-up

Flywheel Damper



AT related

Torque Converter



AT Solenoid



Accessories related

Spoiler



Roof Rail



Others AT Fluid

ATF



CVT



Brake Booster



www.aisinaftermarket.jp



100% OE Quality You Can Trust.

Spring 2010: AISIN's precision honed brake hydraulics and SEI's OE quality brake pads will become ADVICS.

ADVICS is the premier brake systems supplier to car manufacturers around the world.



Products Catalog

Clutch



AISIN's original equipment technology and know-how is used to ensuring product quality.

Cover Features

- Aisin's "Hot Seating" process stabilizes performance of the diaphragm spring.
- Diaphragm Spring Turnover (DST) type cover improves release of pressure plate.
- Higher load capacity, achieved by the latest designs enables an increase in vehicle application.

Disc Features:

- Premium quality, heat resistant and less abrasive facings ensures
- extended service life of clutch components.
- Aisin's disc spring design enhances engagement and release performance.
Floating rubber cushions or twin-hub types ensure low twisting rigidity to reduce noise, vibration and harshness.

Water Pump



AISIN, the No. 1 original equipment manufacturer of water pumps in the world, manufactures for the aftermarket to protect engines from severe heat.

Features

- Engine specific water pressure is achieved without excessive load to engine.
- Aisin's aluminum die-casting technology allows for size and weight reduction.
- Improved strength in body design and carbon ceramic mechanical seals assures leak prevention.



High precision machining process for Water Pumps

Hydraulics



AISIN's original equipment technology and know-how is applied to design and engineer hydraulics. Each part is manufactured vehicle specific, ensuring product quality and reliability.

Features

- Precision honing of hydraulic cylinders are monitored under OE quality control standards.
- Anodizing and "Kanizen" plating of cylinder bodies strengthens surface, ensuring smooth operation of the piston, and resists corrosion.
- Heat resistant and extended life Ethylene Propylene Rubber (EPDM) seals prevent leakage.
- Quick response design reacts to driver's clutch and brake pedal input.



All weather performance testing for vehicle Hydraulics

Oil Pump

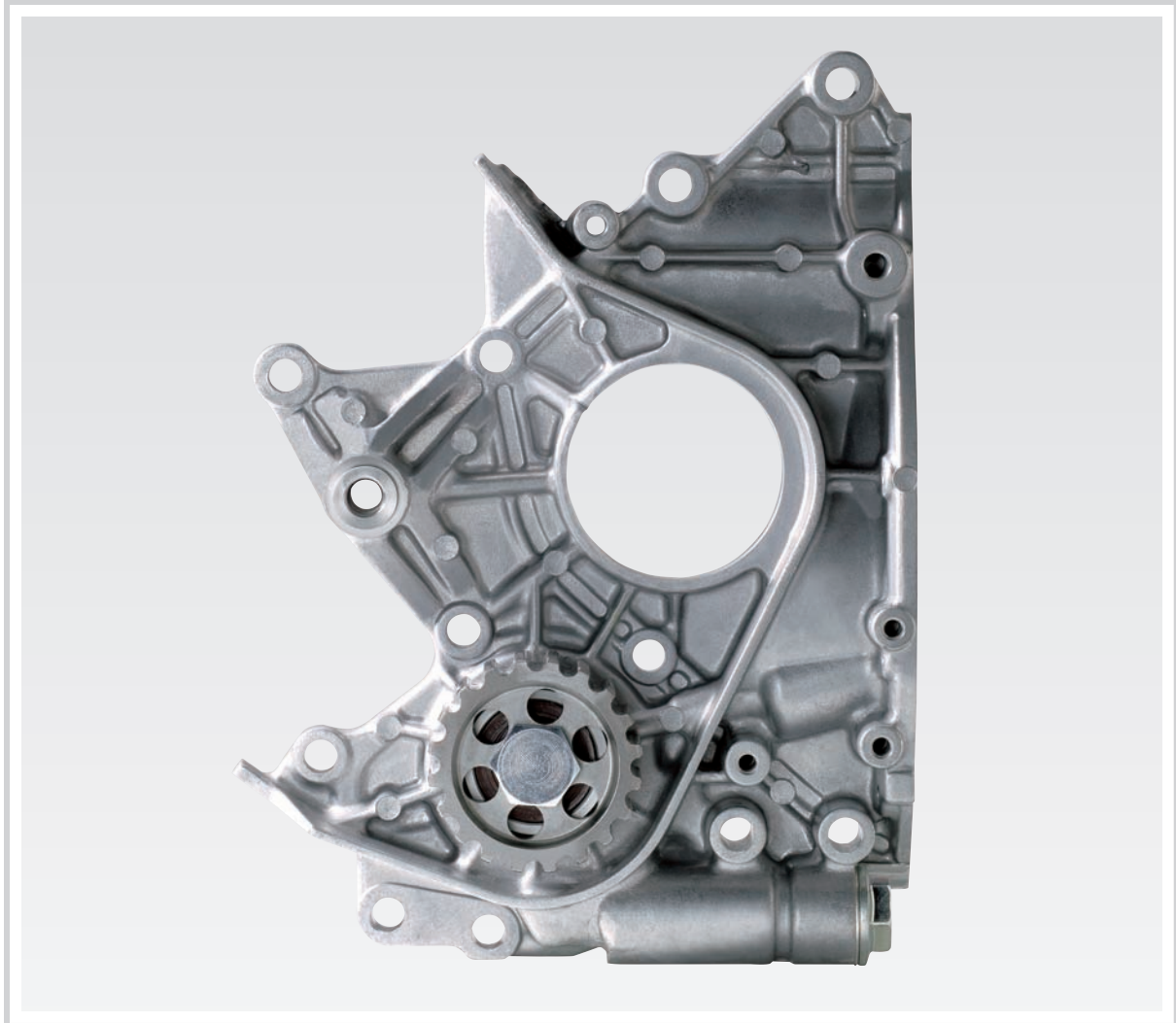

Engineered to exacting OE specifications, AISIN Oil Pumps deliver ideal oil pressure to the engine without creating excess load. Lubricating critical components to extend the life of the engine, AISIN Oil Pumps are always OE Matched.

Features

- Delivers ideal oil pressure to the engine without creating excess load.
- AISIN aluminum die-casting technology allows for size and weight reduction.
- Lubricates critical components to maximize the life of the engine.



Oil pump test on engine dynamometer

ATF







World renowned for transmission development and manufacturing, AISIN Drivetrain Engineering has introduced the AISIN Automatic Transmission Fluid (ATF). By applying decades of knowledge, experience, and development in cooperation with automotive manufacturers, AISIN has developed a state of the art ATF that will maximize performance and longevity of automotive transmissions. AISIN is the only transmission manufacturer to engineer its own ATF. Along with traditional transmission platforms, AISIN has also developed a CVT (Constant Velocity Transmission) transmission fluid.

Features

- Excellent low-temperature flow and viscosity characteristics ensure smooth engaging even in severe winter weather conditions.
- Optimally engineered fluid friction coefficient ensures swifter gear selection and reduces shift shock.
- Optimally engineered fluid friction coefficient reduces drivetrain power loss through the transmission which enables better start and acceleration.

(○:Best match)

	 AFB (At Fluid Basic)	 AFS (At Fluid Superior)	 AFW (At Fluid Wide range)	 CFB (CVT Fluid Basic)
General AT	○		○	
Slip control AT		○	○	
Metallic belt type CVT*				○

(*) Not for use with Honda Multi-Matic[Honda Multi-Matic is the registered trademark of Honda Motor Co., Ltd.]

AISIN ATF Coverage spans almost all vehicle applications!

AISIN ATF Application List

Car Maker	Genuine ATF	Application		
		AFW	AFB	AFS
Toyota	Auto Fluid Type T	○	×	×
	Auto Fluid Type T-II	○	○	○
	Auto Fluid Type T-III	○	×	○
	Auto Fluid Type T-IV	○	×	○
	CVT Fluid TC	×	×	×
	Auto Fluid Dexron II E	○	○	×
	Auto Fluid Dexron III	○	○	×
	Auto Fluid WS	×	×	×
Nissan	Matic Fluid D (Not for CVT Cars)	○	○	×
	Matic Fluid J	○	×	○
	Matic Fluid D (For CVT Cars)	×	×	×
	CVT Fluid NS-1	×	×	×
	CVT Fluid NS-2	×	×	×
	CVT Fluid KTF-1	×	×	×
Honda	Matic Fluid C, D/ATF M-III	○	○	×
	Honda Ultra ATF (Not for CVT Cars)	○	○	○
	Honda Ultra ATF/Honda Ultra ATF-Z1 (For CVT Cars)	×	×	×
Mitsubishi	Honda Ultra ATF-Z1 (Not for CVT Cars)	○	○	○
	Diaqueen ATF SP II/SP II M	○	○	○
	Diaqueen ATF SP III (Not for CVT Cars)	○	×	×
Mazda	Diaqueen ATF SP III (For CVT Cars)	×	×	×
	ATF-M III	○	○	×
	ATF S-1	○	○	×
	ATF N-1	○	×	×
	ATF M-V	○	×	○
Subaru	ATF F-1	○	×	×
	Subaru ATF	○	○	×
	ECVT Fluid (Not for CVT Cars)	○	○	×
	ECVT Fluid (For CVT Cars)	×	×	×
	I-CVT Fluid (For CVT Cars)	×	×	×
Isuzu	Opel Original ATF 09117946	○	×	×
	Besco Dexron II E	○	○	×
	Besco ATF III	○	×	○
Suzuki	Besco Navi-5 (For CVT Cars)	×	×	×
	ATF Dexron II E	○	○	×
	ATF 5D06	○	○	×
	S-CVT (For CVT Cars)	×	×	×
	Suzuki CVT Oil (For CVT Cars)	×	×	×
	ATF 2384K	○	○	×
	ATF 3314	○	×	○
	ATF 3317	○	×	○
Daihatsu	Gear Oil (For CVT Cars)	×	×	×
	Amix ATF Multi	○	○	○
	Amix ATF D III-SP	○	×	○
GM	Gear Oil (For CVT Cars)	×	×	×
	Dexron III	○	○	×
Ford	Dexron II-E	○	○	×
	Mercon	○	×	×
	M2C33-F	×	×	×
Chrysler	Mercon V	○	×	×
	Dexron II-E	○	○	×
	Type 7176/ATF+3	×	×	×

Car Maker	Genuine ATF	Application		
		AFW	AFB	AFS
Audi	Dexron II-E	○	○	×
	G 052 162 A2	×	×	×
	CTV Oil	×	×	×
Benz	Dexron II-E	○	○	×
	Original Oil	○	×	×
BMW	Dexron II-E	○	○	×
	ATF-D3	×	×	×
	LT-71141	×	×	×
	Original Oil	×	×	×
VW	Dexron II-E	○	×	○
	G 052 162 A2	×	×	×
Opel	Dexron II-E	○	×	○
	Original Oil	○	×	×
Porche	Dexron II-E	○	○	×
Renault	Dexron II-E	○	○	×
Peugeot	Dexron II-E	○	○	×
Citroen	Dexron II-E	○	○	×
Volvo	Dexron II-E/Mercon	○	○	×
	Dexron II-E	○	○	×
	Dexron III-G	○	×	×
SAAB	M2C33-G	×	×	×
	Dexron II-E	○	○	×
Rover	Dexron II-E	○	○	×
	Unipart Superflow CVT Fluid	×	×	×
Jaguar	Dexron II-E	○	○	×
	M2C33-F	×	×	×
	LT-71141	×	×	×
Fiat	Dexron II-E	○	○	×
Alfa Romeo	Dexron II-E	○	○	×
	Tutela CS Speed	×	×	×
Lancia	Dexron II-E	○	○	×

○=You can use
 ×=You cannot use

Fan Blade



Engineered to exacting OE specifications, our fan blade makes cars lighter in weight and higher in performance through diversity of products for drive systems, engines, and vehicle bodies.

Features

- Reduce air pressure between fan and radiator by fan rotation.
 - Cooling of radiator with air ventilation from pressure fluctuation.
-

Fan Clutch

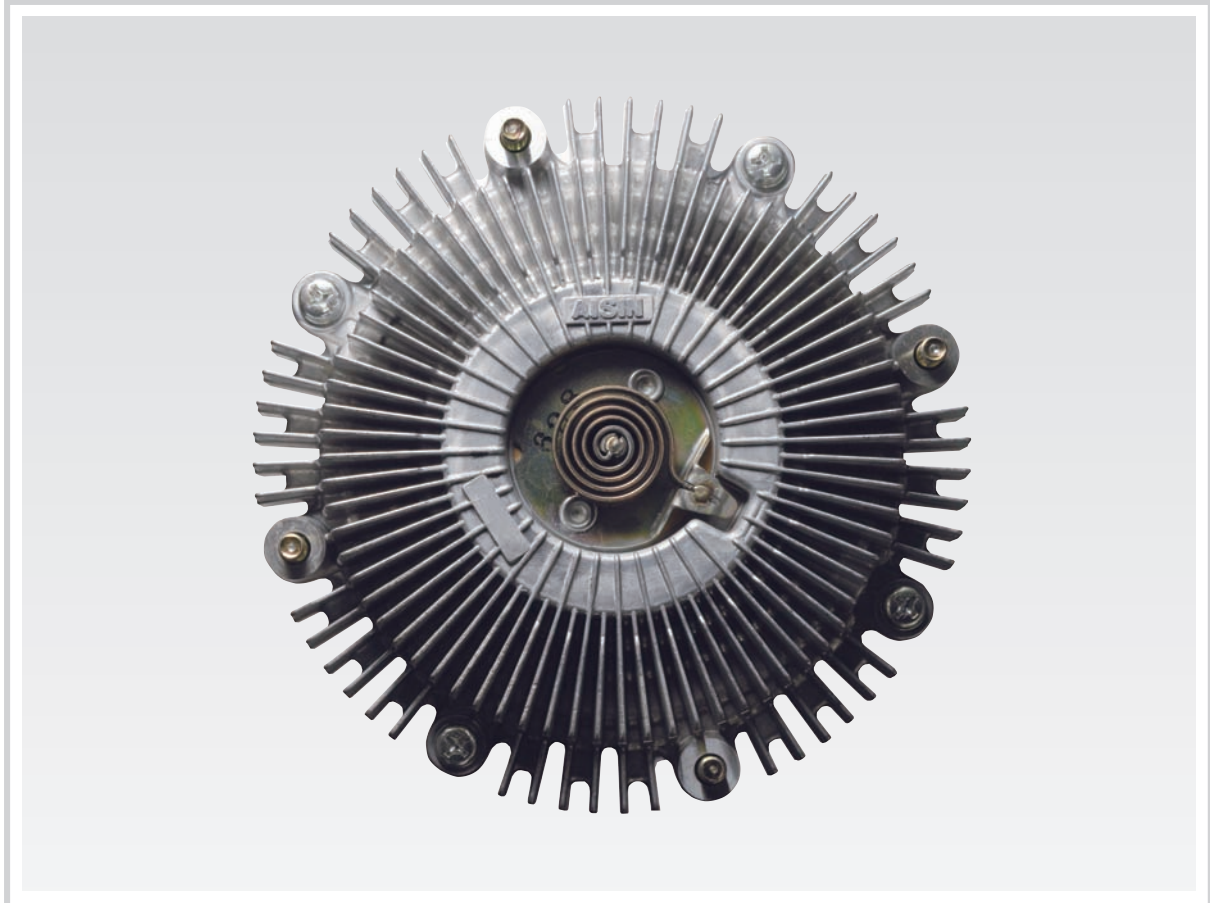

Engineered to exacting OE specifications, AISIN Fan Clutch quickly adjusts to temperature changes to provide efficient, controlled cooling. Providing optimal cooling performance without sacrificing engine efficiency, AISIN Fan Clutches are always OE Matched.

Features

- Manufactured with the highest quality materials to withstand heat and vibration while adjusting coolant temperature for optimal engine efficiency.
- Delivers precise fan speeds in proportion to engine RPM, providing optimal cooling to exacting OE specifications.
- As a vital cooling component, the installer and user will have the peace of mind that the parts are manufactured by one of the leading Tier 1 suppliers in the world.



Free Wheel Hub



Engineered to exacting OE specifications, AISIN Free Wheel Hubs efficiently transfers and disconnects drivetrain power to part time 4 Wheel Drive applications. Compact in design and durable against the toughest terrain, AISIN Freewheel Hubs are manufactured to the highest standards and are always OE Matched.

Features

- Compact and durable design withstands the same rugged terrain tests performed by the vehicle manufactures.
- Robust locking mechanism provides reliable connection of the drivetrain power to the wheels in 4 Wheel Drive mode.
- Large manual dial allows the user to effortlessly change from 2 Wheel Drive to 4 Wheel Drive mode.



Hydraulic Belt Tensioner



Engineered to exacting OE specifications, AISIN Hydraulic Belt Tensioners deliver ideal tension to the timing belt. Maintaining reliability by automatically adjusting belt tension, AISIN Hydraulic Timing Belt Tensioners are always OE Matched.

Features

- Utilizes hydraulic pressure to deliver optimal belt tension, automatically adjusting throughout the RPM range.
- AISIN OE Engineering developed pressurizing mechanism efficiently dampens timing belt vibrations.
- Manufactured with the highest quality materials to maximize durability.



Timing Chain Cover

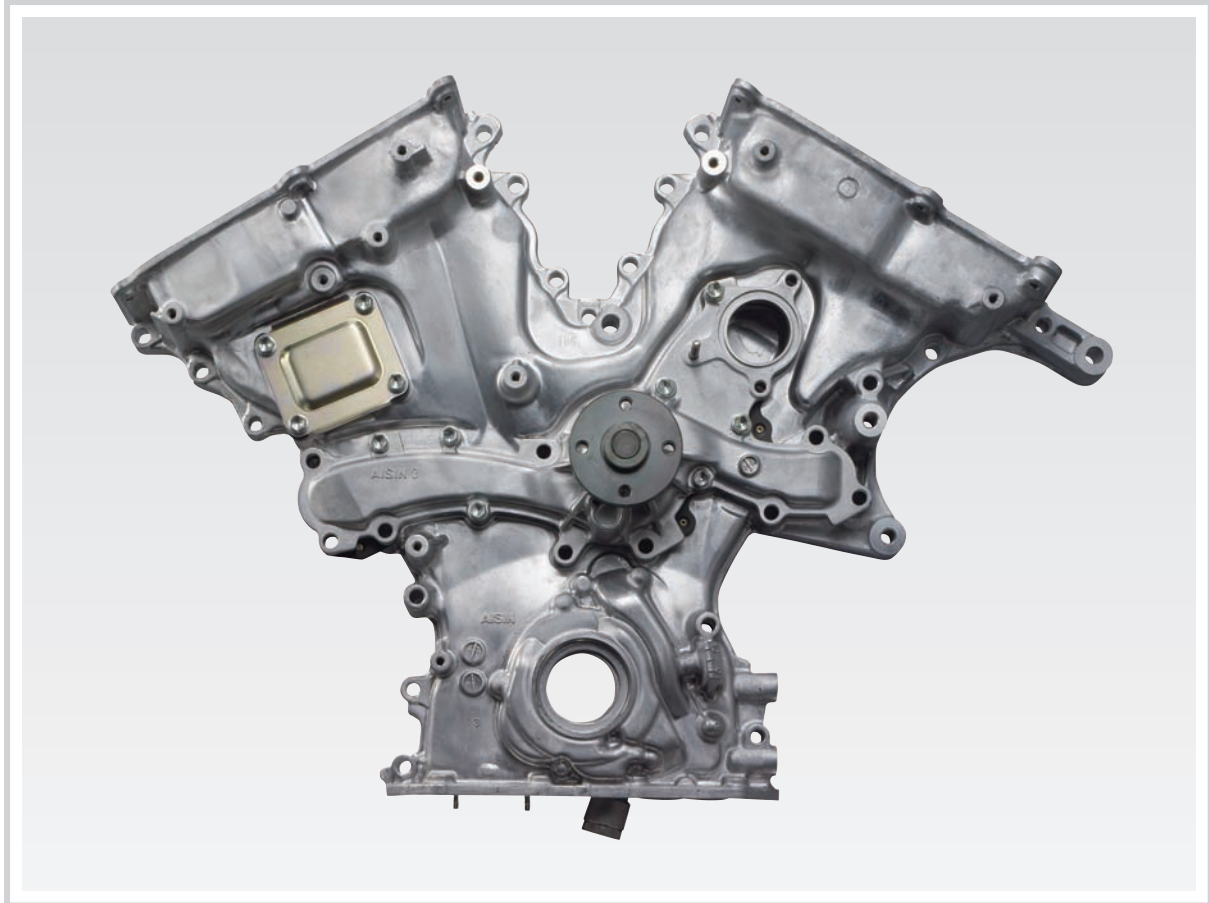

Engineered to exacting OE specifications, AISIN Timing Chain Cover, equipped with an AISIN brand Water Pump, Oil Pump and Fan Clutch, offers precise fitment, optimal cooling and lubrication. Providing protection for vital moving parts, AISIN Timing Chain Cover are always OE Matched.

Features

- Precision fitment to protect the timing chain and gears from debris.
- Module-Oriented assembly allow for easy, one step replacement of the timing chain cover, water pump, oil pump and fan clutch (when applicable).
- Optimal cooling and lubrication to exacting OE specifications.

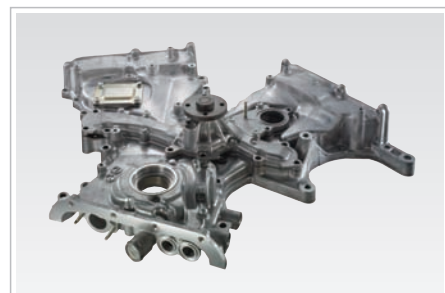

Fan Pulley Bracket



Engineered to exacting OE specifications, AISIN Fan Pulley Brackets are built with the highest quality materials and robust design. Maintaining structure and supporting the clutch fan, AISIN Fan Pulley Brackets are always OE Matched.

Features

- Optimal geometrical design maintains structural integrity, ensuring fan clutch stability.
- Equipped with the highest quality bearings to support extreme clutch fan rotations.
- AISIN aluminum die-casting technology allows for size and weight reduction.



Flywheel Damper



Engineered to exacting OE specifications, AISIN Flywheel Dampers are designed to reduce torsional vibration created by diesel or high performance engine. Sometimes they are called Dual Mass Flywheel, AISIN Flywheel Dampers are always OE matched.

Features

- AISIN OE Engineering developed, the flywheel is divided into two portions, one for the engine (primary flywheel), and the other for the transmission (secondary flywheel).
- Between them, lightweight coilsprings are laid out in-line, with both ends of each coil spring supported by sheets.

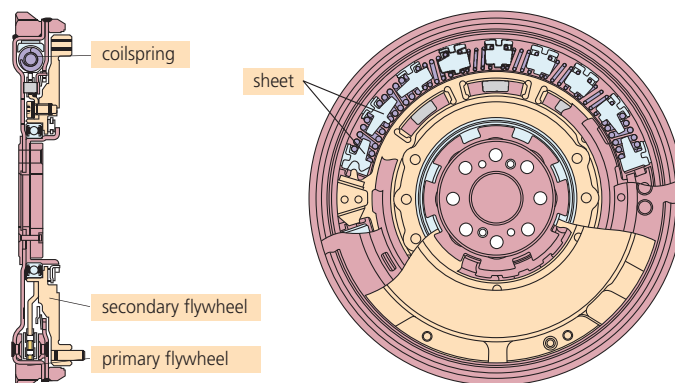

Sales Office



AISIN SEIKI CO., LTD

aftermarket dept.

2-1, Asahi-machi, Kariya, Aichi, 448-8650 JAPAN

Telephone +81-566-24-8523 Facsimile +81-566-24-8996

www.aisinaftermarket.jp

AISIN WORLD CORP. OF AMERICA

24330 Garnier Street, Torrance, California 90505, U.S.A.

Telephone +1-310-326-8681 Facsimile +1-310-533-8271

www.aisinworld.com

AISIN EUROPE S.A.

Avenue de L'Industrie 21, Parc Industriel,

1420 Braine-L'Alleud, BELGIUM

Telephone +32-2-387-0136 Facsimile +32-2-387-0633

www.be.aisin-europe.com

AISIN ASIA PTE. LTD

10 Anson Road, #31-11/12, International Plaza,

Singapore 079903, SINGAPORE

Telephone +65-6222-0592 Facsimile +65-6225-0911

www.aisin.com.sg

AISIN ASIA MIDDLE EAST BRANCH

6WA 109, Dubai Airport Free Zone,

P.O Box 54416, Dubai, U.A.E.

Telephone +97-14-299-3925

Facsimile +97-14-299-3926

AISIN ASIA PACIFIC Co., Ltd.

947 2nd Floor, Thodsapol Land 3 Building, Room A Moo 12,
Bangna-Trad Rd., Kwang Bangna, Khet Bangna Bangkok 10260

THAILAND

Telephone +66-2398-6212

Facsimile +66-2398-6309

爱信精机(天津)商贸有限公司 广州分公司

中华人民共和国广东省广州市环市东路368号花园大厦1219室

Telephone +86-20-8387-8835

Facsimile +86-20-8384-9456

www.aisinaftermarket.jp

5 New Features

- 1 Quick Search Part Number Interchange**
- 2 New Parts Updates**
- 3 Tool Library for Sales Promotion**
- 4 New Topics**
- 5 Product Details**



1 Quick Search

Shorten application look up time!

Look up Genuine No. to AISIN No. directly and shorten product inquiry time by accessing our online part number interchange.

2 New Parts Updates

Up to date information for new product releases!

Information center for new products and application changes. Stay informed with the latest data updated directly from AISIN.

3 Tool Library

Direct access to sales promotion tools!

Catalogs, bulletins, diagnostic manuals, and other helpful marketing items that may help in promoting AISIN products.

4 New Topics

News from around the world!

Keep up to date with developments from AISIN affiliates across the globe. The ideal place for international information exchange for the ever expanding global market.

5 Product Detail

Expanded AISIN Aftermarket Product Line-Up!

AISIN, known world-wide as a leader in clutch technology, has other OE Matched quality parts available. Check out our other product lines for your aftermarket needs.



IMPORTANT NOTICE

The purpose of this catalog is to furnish our customers with as complete a listing of parts requirements as possible.

All listings, applications or interchanges contained in this catalog are based on the latest information available at the time of printing. Every effort has been made to ensure that the information contained in this catalog is correct, but we do not assume any responsibility for errors which may occur.

All references to manufactures names or part numbers are only used as a guide when ordering parts.

Cross Reference List

● Fan Blade	26
● Fan Clutch	33
● Free Wheel Hub	37
● Hydraulic Belt Tensioner.....	38
● Timing Chain Cover	39
● Fan Pulley Bracket	41
● Flywheel Damper	42

Cross Reference List / Fan Blade

Genuine No.	Aisin No.	Make	Model	Year	Engine Type	Body Type
16361-17010	FNT-010	TOYOTA	LAND CRUISER	90. 01-90. 11	1PZ	PZJ7#
			COASTER	90. 01-93. 01	1H#	HDB30
16361-17030	FNT-015	TOYOTA	LAND CRUISER	99. 08-01. 08	1HZ	HZJ7#
			COASTER	04. 08-	1HZ	HZB50
16361-17040	FNT-024	TOYOTA	COASTER	99. 07-04. 08	1HZ	HZB50
			LAND CRUISER	99. 08-06. 02	1HZ	HZJ79, 78
			LAND CRUISER 100	00. 08-02. 08	1HDFTE	HDJ100
16361-31060	FNT-007	TOYOTA	4RUNNER	02. 11-04. 08	1GRFE	GRN21#
			LAND CRUISER 120	03. 01-	1GRFE	GRJ12#
			TUNDRA	04. 08-	1GRFE	GSK30
			TACOMA	04. 09-08. 05	1GRFE	GRN225, 245, 250, 265, 270
			HILUX	05. 02-08. 10	1GRFE	GGN25
			FORTUNER	05. 07-08. 08	1GRFE	GGN50
			FJ CRUISER	06. 01-	1GRFE	GSJ1#
			LAND CRUISER(CHINA)	07. 12-	1GRFE	GRJ200
			LAND CRUISER PRADO	09. 08-	1GRFE	GRJ150
			16361-38010	FNT-003	TOYOTA	CELICA
COASTER	77. 08-82. 04	20R, 22R				RB11, 13
PICKUP	78. 08-83. 07	20R, 22R				RT13#
CORONA	79. 08-83. 01	1X				XT130
CROWN	79. 09-83. 07	L				LS110
CRESSIDA	80. 09-85. 04	L				LX60
CARINA	82. 04-83. 09	1C				CA60
LITEACE	82. 10-85. 08	1C				CM20
COROLLA	82. 10-87. 07	1C				CE70
MODEL-F	82. 11-87. 08	2C				CR21
VAN	83. 08-87. 08	3YEC, 4YEC				YR2#, 3#
TRUCK 4-RUNNER	83. 08-89. 03	22R#				RN5#, 6#, 7#
HIACE VAN, COMUTER	84. 01-86. 08	3Y				YH61
DYNA100	85. 05-93. 08	2Y				YH81
LITEACE VAN, WAGON	85. 10-88. 08	1C				CM35
CORONA FR	86. 12-99. 07	2Y				YT140
HILUX 2W	88. 08-97. 08	2Y				YN85
HILUX/ 4RUNNER(4W)	88. 08-99. 09	22R#				RN10#, 110, 13#
CRESSIDA WAGON	88. 10-93. 02	22R				RX7#

Genuine No.	Aisin No.	Make	Model	Year	Engine Type	Body Type			
16361-41090	FNT-013	TOYOTA	LAND CRUISER	90. 04-93. 05	22R	RJ7#			
			HIACE/HIACE S. B. V	95. 08-99. 07	2RZE	RCH12, 18, 22, 28			
			TOWNACE/LITEACE	96. 11-98. 12	5K, 7K	KR4#			
			T. U. V	96. 12-03. 02	7KE, 7K#	KF60, 7#, 80, 82			
			CROWN COMFORT	99. 08-	3YPE	YXS10			
			CROWN	79. 09-83. 07	4M, 5M#	MS11#			
			CRESSIDA	80. 08-85. 04	5ME	MA6#			
			CELICA	81. 12-85. 12	5M#	MA61			
			SUPRA	86. 01-88. 08	7MG#	MA70			
			COASTER	86. 10-90. 01	12HT, 2H	HB3#			
			CRESSIDA WAGON	88. 12-92. 05	7MGE	MX75			
16361-44032	FNT-027	TOYOTA	MEGA CRUISER	96. 10-	15BFT	BXD20			
			CROWN	79. 09-83. 07	5R	RS110			
			HILUX	83. 08-86. 08	1Y, 3Y, 4Y	YN50, 52, 55, 57, 6#			
			DYNA 100	85. 08-87. 08	1Y	YH80			
			LITEACE	85. 09-88. 08	5K	KM3#			
			HIACE VAN, COMUTER	86. 08-87. 08	3Y	YH51, 61			
			STOUT	86. 09-00. 02	4Y	YK110			
			HILUX/ 4RUNNER(4W)	88. 08-97. 08	4Y	YN106, 135			
			HILUX 2W	88. 08-99. 09	2Y, 3Y, 4Y	YN8#, 9#			
			16361-46040	FNT-008	TOYOTA	SUPRA	93. 05-96. 05	2JZGE	JZA80
						CROWN	93. 05-96. 05	2JZGE	JZA80
16361-50020	FNT-028	TOYOTA	CROWN/CROWN MAJESTA	95. 08-	1UZFE	UZS15#			
16361-50040	FNT-012	TOYOTA	LAND CRUISER	98. 01-02. 08	2UZFE	UZJ100			
16361-50080	FNT-016	TOYOTA	SEQUOIA	00. 09-04. 08	2UZFE	UCK35, 45			
			TUNDRA	02. 08-04. 08	2UZFE	UCK3#, 4#			
			4RUNNER	02. 08-04. 11	2UZFE	UZN21#			
16361-50110	FNT-014	TOYOTA	TUNDRA	04. 08-	2UZFE	UCK3#, 4#			
			SEQUOIA	04. 08-	2UZFE	UCK35, 45			
			4RUNNER	04. 11-05. 08	2UZFE	UZN21#			
			LAND CRUISER	07. 09-	1VDFTV	VDJ200			
16361-54020	FNT-019	TOYOTA	LAND CRUISER	07. 12-	2UZFE	UZJ200			
			HILUX	84. 08-85. 08	2L	LN5#, 6#			
			TRICK 4-RUNNER	85. 08-87. 08	2L#	LN56, 66			
			DYNA100	85. 08-87. 08	2L	LH80			

Genuine No.	Aisin No.	Make	Model	Year	Engine Type	Body Type
16361-54040	FNT-001	TOYOTA	HIACE VAN, COMUTER	85. 08-87. 08	2L	LH5#
			LAND CRUISER	85. 10-90. 01	2LT	LJ7#
			CROWN	87. 09-89. 08	2L	LS130
			HILUX 2W	88. 08-91. 08	2L	LN85
			HIACE/HIACE S. B. V	99. 07-01. 08	2L	LXH12
			DYNA100	88. 08-95. 05	2L	LH80
			HILUX/ 4RUNNER(4W)	88. 08-01. 06	3L	LN10#, 111, 13#
			HILUX 2W	88. 08-01. 06	2L, 3L	LN80, 81, 85, 86, 9#
			LAND CRUISER	89. 04-	3B	BJ73, VM
			T. U. V	96. 12-98. 01	2L	LF60, 70, 80
16361-54070	FNT-006	TOYOTA	HILUX	97. 08-05. 06	2L, 3L	LN5#, 67
			LAND CRUISER	89. 01-	3B	BJ73
			DYNA100	95. 05-	2L	LY100
			HILUX	97. 08-01. 08	2L#	LN145, 150, 165, 170
			T. U. V	98. 01-01. 02	2L	LF60, 7#, 80, 82
			HIACE VAN, COMUTER	98. 08-99. 07	3L	LH115
16361-54111	FNT-021	TOYOTA	QUALIS	99. 12-04. 12	2L	LF50
			HILUX	97. 08-01. 08	3L, 5L	LN147, 152, 157, 16#, 172, 192
			T. U. V	00. 04-03. 06	5L	LF61, 81, 85
16361-54131	FNT-020	TOYOTA	HILUX	00. 08-01. 08	2LT	LN190
			HILUX 2W	01. 06-04. 12	5L	LN200
			HILUX/ 4RUNNER(4W)	01. 06-04. 12	5L	LN205
			FORTUNER	06. 05-08. 10	5LE	LAN50
16361-60101	FNT-017	TOYOTA	HEAVY DUTY TRUCK	76. 04-82. 07	F	FA100, 115
			LAND CRUISER	80. 08-86. 04	2F	FJ4#, 55
16361-61020	FNT-022	TOYOTA	LAND CRISER	80. 08-84. 10	2F	FJ40, 45
16361-61050	FNT-018	TOYOTA	LAND CRISER	90. 01-92. 08	3FE	FJ80
16361-62010	FNT-005	TOYOTA	T100	94. 08-	5VZFE	VCK11, 21
			TACOMA	95. 01-00. 09	5VZFE	VZN160, 170
			4RUNNER	95. 11-	5VZFE	VZN18#
			LAND CRUISER 90	99. 06-02. 09	5VZFE	VZJ9#
			TUNDRA	01. 08-	5VZFE	VCK30, 40
			HILUX	02. 08-05. 02	5VZFE	VZN18#
16361-65010	FNT-011	TOYOTA	TRUCK 4-RUNNER	87. 11-89. 03	3VZE	VZN6#
			HILUX/ 4RUNNER(4W)	90. 08-93. 08	3VZE	VZN130

Genuine No.	Aisin No.	Make	Model	Year	Engine Type	Body Type			
16361-65020	FNT-029	TOYOTA	T100	92. 08-93. 08	3VZE	VCK10, 20			
			T100	93. 08-94. 08	3VZE	VCK10, 20			
			TRUCK 4-RUNNER	93. 08-95. 11	3VZE	VZN120, 90			
16361-66020	FNT-004	TOYOTA	HILUX/ 4RUNNER(4W)	93. 08-95. 11	3VZE	VZN130			
			LAND CRUISER	92. 08-98. 01	1FZFE	FZJ80			
16361-67020	FNT-009	TOYOTA	LAND CRUISER	93. 05-96. 04	1KZT	KZJ7#			
16361-67030	FNT-023	TOYOTA	4RUNNER	95. 11-	1KZ#	KZN185			
			DYNA150	01. 08-	1KDFTV, 2KDFTV	KDY22#, 23#, 25#, 26#			
			HILUX	01. 08-05. 08	2KDFTV	KDN145, 150, 165, 170, 190			
			LAND CRUISER PRADO	02. 09-	1K#	KDJ120, KZJ120			
			HIACE/HIACE S. B. V	06. 08-	2KDFTV	KLH1#, 2#			
			HIACE VAN, COMUTER	98. 08-99. 07	5L	LH166, 17#, 184			
			HIACE/HIACE S. B. V	99. 07-01. 08	2LT	LXH1#, 2#			
16361-67040	FNT-026	TOYOTA	DYNA 150	01. 07-	5L	LY22#, 23#			
			LAND CRUISER 90	00. 08-02. 09	1KZTE	KZJ95			
			HILUX/ 4RUNNER(4W)	01. 08-04. 12	1KZTE	KZN205			
16361-70040	FNT-030	TOYOTA	HILUX	01. 09-05. 04	1KZTE	KZN165, 190			
			COASTER	06. 08-09. 08	NO4C	XZB50			
			COASTER(CHINA)	07. 01-	NO4C	XZB53			
			CRESSIDA	88. 08-93. 02	1GFE	GXS1			
			CROWN	88. 12-91. 10	1GFE	GS131			
16361-75020	FNT-002	TOYOTA	TACOMA	95. 01-00. 09	3RZFE	RZN161, 171			
			T100	95. 04-	3RZFE	RCK10			
			T100	95. 04-96. 08	3RZF	RCK10			
			4RUNNER	95. 11-00. 08	3RZFE	RZN18#			
			HILUX	97. 08-01. 08	2RZFE	RZN168, 173			
			HIACE/HIACE S. B. V	98. 04-99. 10	3RZFE	RCH13, 19, 23, 29. . DX, STD			
			LAND CRUISER 90	99. 06-02. 09	3RZFE	RZJ90, 95			
			T. U. V	99. 11-03. 06	1RZE, 2RZE	RZF71, 80, 81, 84, 85			
			HILUX 2W	01. 06-04. 12	3RZFE	RZN200			
			QUALIS	02. 01-04. 12	1RZE	RZE50			
			LAND CRISER PRADO	04. 08-	2TRFE	TRJ12#			
			CROWN COMFORT	08. 08-	1TRFPE	TSS10			
			16361-76060	FNT-025	TOYOTA	PREVIA	90. 10-91. 12	2TZFE	TRC1#, 2#
						MD041078	FND-002	DAIHATSU	

Genuine No.	Aisin No.	Make	Model	Year	Engine Type	Body Type
16361-87502	FND-001	DAIHATSU				
S1630-62300	FNR-004	HINO				
S1630-62300	FNR-028	HINO				
S1630-62351	FNR-010	HINO				
S1630-62610	FNR-027	HINO				
16306-1041A	FNR-006	HINO				
16306-1062A	FNR-009	HINO				
16306-1130	FNR-007	HINO				
16306-1183A	FNR-012	HINO				
16306-1341	FNR-020	HINO				
16306-1933B	FNR-017	HINO				
16306-1942	FNR-018	HINO				
16306-1981A	FNR-019	HINO				
16306-2050	FNR-015	HINO				
16306-2060	FNR-021	HINO				
16306-2080A	FNR-022	HINO				
16306-2140	FNR-024	HINO				
16306-2160B	FNR-003	HINO				
16306-2220B	FNR-005	HINO				
16306-2280	FNR-001	HINO				
16306-2390	FNR-011	HINO				
16306-2410B	FNR-023	HINO				
16306-2420A	FNR-025	HINO				
16306-2430A	FNR-029	HINO				
16306-2451	FNR-013	HINO				
16306-2490	FNR-026	HINO				
16306-2500	FNR-016	HINO				
16306-2522	FNR-014	HINO				
16306-2600	FNR-002	HINO				
16306-2671A	FNR-008	HINO				
16361-E0020	FNR-031	HINO				
16361-E0050	FNR-030	HINO				
1-13660-140-0	FNG-006	ISUZU				
1-13660-148-0	FNG-004	ISUZU				
1-13660-156-0	FNG-007	ISUZU				

Genuine No.	Aisin No.	Make	Model	Year	Engine Type	Body Type
5-13660-046-1	FNG-008	ISUZU				
5-13660-236-0	FNG-010	ISUZU				
5-13660-300-0	FNG-001	ISUZU				
5-13660-308-0	FNG-005	ISUZU				
5-13662-012-0	FNG-003	ISUZU				
8-94117-866-0	FNG-002	ISUZU				
8-94393-117-0	FNG-009	ISUZU				
16306-2480	FNG-011	ISUZU				
MC568194	FNM-001	MITSUBISHI				
MD011149	FNM-011	MITSUBISHI				
MD023696	FNM-004	MITSUBISHI				
ME005002	FNM-010	MITSUBISHI				
ME005162	FNM-007	MITSUBISHI				
ME015750	FNM-005	MITSUBISHI				
ME035139	FNM-003	MITSUBISHI				
ME035219	FNM-008	MITSUBISHI				
ME035309	FNM-009	MITSUBISHI				
ME039861	FNM-018	MITSUBISHI				
ME039960	FNM-019	MITSUBISHI				
ME039970	FNM-022	MITSUBISHI				
ME055056	FNM-016	MITSUBISHI				
ME055140	FNM-023	MITSUBISHI				
ME055319	FNM-020	MITSUBISHI				
ME060129	FNM-021	MITSUBISHI				
ME065378	FNM-014	MITSUBISHI				
ME075027	FNM-006	MITSUBISHI				
ME075091	FNM-002	MITSUBISHI				
ME075190	FNM-024	MITSUBISHI				
ME075202	FNM-012	MITSUBISHI				
SSA43-1B001	FNM-028	MITSUBISHI				
SSA43-1B004	FNM-029	MITSUBISHI				
XM438474	FNM-027	MITSUBISHI				
16306-1861	FNM-025	MITSUBISHI				
30948-32400	FNM-013	MITSUBISHI				
31248-34100	FNM-017	MITSUBISHI				

Genuine No.	Aisin No.	Make	Model	Year	Engine Type	Body Type
31248-39100	FNM-015	mitsubishi				
91201-10200	FNM-026	mitsubishi				
17110-60A00	FNS-006	suzuki				
17110-60A10	FNS-007	suzuki				
17110-77300	FNS-005	suzuki				
17111-73000	FNS-003	suzuki				
17111-73010	FNS-008	suzuki				
17111-83000	FNS-004	suzuki				
1317465	FNV-001	volvo				
16311-31220-71	FNW-003	INDUSTRIAL VEHICLE				
16361-22020-71	FNW-008	INDUSTRIAL VEHICLE				
16361-22040-71	FNW-005	INDUSTRIAL VEHICLE				
16361-23060-71	FNW-006	INDUSTRIAL VEHICLE				
16361-23860-71	FNW-002	INDUSTRIAL VEHICLE				
16361-31620-71	FNW-004	INDUSTRIAL VEHICLE				
16361-32080-71	FNW-007	INDUSTRIAL VEHICLE				
16361-33900-71	FNW-009	INDUSTRIAL VEHICLE				
16361-40120-71	FNW-010	INDUSTRIAL VEHICLE				
16361-42800-71	FNW-011	INDUSTRIAL VEHICLE				
16361-78501-71	FNW-001	INDUSTRIAL VEHICLE				
121950-44741	FNY-001	yamaha				

Cross Reference List / Fan Clutch

Genuine No.	AISIN No.	Make	Model	Engine Type	Body Type
08921-04950	FCT-064	TOYOTA			
16210-13010	FCT-045	TOYOTA	LITE-ACE, TOWN-ACE		
16210-13020	FCT-052	TOYOTA			
16210-13030	FCT-031	TOYOTA	LITE-ACE, TOWN-ACE		
16210-17010	FCT-034	TOYOTA	LAND CRUISER		
16210-17021	FCT-016	TOYOTA			
16210-17030	FCT-040	TOYOTA	COASTER		
16210-17050	FCT-039	TOYOTA	LAND CRUISER	1HD	HZJ71, 74, 76, HDJ101K
16210-17070	FCT-030	TOYOTA		1HD	
16210-17080	FCT-074	TOYOTA	COASTER		
16210-18010	FCT-056	TOYOTA			
16210-28020	FCT-048	TOYOTA			
16210-30010	FCT-070	TOYOTA	HI-LUX SURF, LAND CRUISER PRADO, DYNA, TOYOACE		
16210-31010	FCT-019	TOYOTA	HI-ACE, HI-LUX		
16210-31020	FCT-072	TOYOTA	HI-LUX, LAND CRUISER PRADO		
16210-35011	FCT-068	TOYOTA	COASTER		
16210-35020	FCT-043	TOYOTA			
16210-38050	FCT-001	TOYOTA	LITE-ACE, TOWN-ACE		
16210-38060	FCT-003	TOYOTA	LITE-ACE		
16210-42030	FCT-060	TOYOTA	SOARE, SUPRA		
16210-42060	FCT-007	TOYOTA	MARK II		
16210-42070	FCT-050	TOYOTA	SOARE, SUPRA		
16210-43032	FCT-032	TOYOTA	CROWN		MS130
16210-45100	FCT-044	TOYOTA			
16210-45110	FCT-041	TOYOTA	SOARE, SUPRA		
16210-46030	FCT-023	TOYOTA	SOARE, SUPRA		
16210-46042	FCT-006	TOYOTA	MARK II, CROWN, ARIST		
16210-50021	FCT-014	TOYOTA	CROWN, CROWN MAJESTA		
16210-50040	FCT-066	TOYOTA			
16210-50051	FCT-021	TOYOTA	LAND CRUISER 100 Series		
16210-50061	FCT-076	TOYOTA			
16210-50072	FCT-005	TOYOTA			
16210-50080	FCT-024	TOYOTA			

Fan Blade

Fan Clutch

Genuine No.	AISIN No.	Make	Model	Engine Type	Body Type
16210-50090	FCT-018	TOYOTA	SEQUIRE	2UZ- FE	
16210-50101	FCT-075	TOYOTA			
16210-52022	FCT-063	TOYOTA	CENTURY		
16210-54040	FCT-059	TOYOTA			
16210-54070	FCT-025	TOYOTA	HI-ACE, HI-LUX		
16210-54090	FCT-062	TOYOTA	HI-ACE		
16210-54130	FCT-051	TOYOTA	CROWN, HI-ACE TRUCK		
16210-54141	FCT-028	TOYOTA	HI-LUX		
16210-54150	FCT-011	TOYOTA	HI-LUX, DYNA, TOYOACE		
16210-54180	FCT-012	TOYOTA	HI-ACE		
16210-54200	FCT-029	TOYOTA	HI-ACE, HI-LUX, DYNA, TOYOACE		
16210-54210	FCT-020	TOYOTA	HI-LUX		
16210-54220	FCT-008	TOYOTA	HI-ACE, DYNA/ TOYOACE	5L	100Series, 100, 200Series
16210-54230	FCT-069	TOYOTA			
16210-56020	FCD-004	TOYOTA			
16210-58012	FCT-057	TOYOTA	COASTER, LAND CRUISER		
16210-58030	FCT-033	TOYOTA	DYNA, TOYOACE		
16210-58041	FCT-055	TOYOTA	COASTER		
16210-61121	FCT-017	TOYOTA			
16210-61150	FCT-015	TOYOTA	LAND CRUISER 70 Series		
16210-61160	FCT-049	TOYOTA	LAND CRUISER		
16210-62011	FCT-013	TOYOTA	HI-LUX, LAND CRUISER PRADO		
16210-62030	FCT-067	TOYOTA	HI-LUX SURF, LAND CRUISER PRADO		
16210-64010	FCT-053	TOYOTA	LITE-ACE, TOWN-ACE		
16210-64020	FCT-047	TOYOTA	LITE-ACE, TOWN-ACE		
16210-64030	FCT-077	TOYOTA	ESTIMA EMINA/ LUCIDA		
16210-65020	FCT-009	TOYOTA	HI-LUX		
16210-65030	FCT-038	TOYOTA	HI-LUX		
16210-66020	FCT-004	TOYOTA	LAND CRUISER		
16210-66040	FCT-065	TOYOTA			
16210-67010	FCT-036	TOYOTA	HI-ACE, HI-LUX, LAND CRUISER		
16210-67030	FCT-010	TOYOTA	HI-LUX, LAND CRUISER PRADO		
16210-67040	FCT-071	TOYOTA			
16210-68011	FCT-058	TOYOTA			

Genuine No.	AISIN No.	Make	Model	Engine Type	Body Type
16210-70022	FCT-046	TOYOTA	CROWN, SOARE, SUPRA		
16210-70040	FCT-035	TOYOTA	CROWN, MARK II		
16210-72010	FCT-054	TOYOTA	MARK II, CROWN		
16210-73010	FCT-037	TOYOTA	LITE-ACE, DYNA, TOYOACE		
16210-75010	FCT-027	TOYOTA	HI-ACE, HI-LUX		
16210-75020	FCT-042	TOYOTA	HI-ACE		
16210-75050	FCT-026	TOYOTA	HI-ACE REGIUS		
16210-75060	FCT-002	TOYOTA	HI-LUX, LAND CRUISER, DYNA, TOYOACE		
16210-75110	FCT-073	TOYOTA			
16210-75120	FCT-078	TOYOTA			
16210-76010	FCT-022	TOYOTA	ESTIMA/ PREVIA		
16210-56020-000	FCD-004	DAIHATSU	DELTA		
16210-87101-000	FCD-001	DAIHATSU	ROCKY		
16210-87103-000	FCD-003	DAIHATSU	TERIOS, ROCKY		
16210-87106	FCD-002	DAIHATSU	TERIOS		
16250-E0040	FCR-005	HINO	RANGER, BUS RAINBOW	J08C	
16250-E0060	FCR-001	HINO			YJ07
16250-E0070	FCR-009	HINO			YF95
16250-E0090	FCR-013	HINO			YF96
16250-E0150	FCR-010	HINO	TRUCK	EK100	
16250-E0160	FCR-006	HINO	RANGER, BUS RAINBOW	H06C-T	
16250-E0210	FCR-012	HINO			RU3FSAH, RU2P
16250-1021B	FCR-004	HINO	BUS RAINBOW	EF100	
16250-1160C	FCR-003	HINO	RANGER, BUS RAINBOW	EH700	
16250-1231A	FCR-007	HINO			YE87
16250-1311A	FCR-011	HINO			Y630
16250-1381A	FCR-014	HINO			YF85
16250-1442A	FCR-002	HINO			WOCT1
16250-1520A	FCR-008	HINO			YF70
1-21650-193-1	FCG-011	ISUZU		LV7	
1-21650-212-1	FCG-010	ISUZU		6WF1	
8-94171-813-0	FCG-002	ISUZU	MU	4ZD1	
8-94311-252-0	FCG-018	ISUZU	MU	4ZE1	
8-94391-701-0	FCG-006	ISUZU	FORWARD	6HE1	

Genuine No.	AISIN No.	Make	Model	Engine Type	Body Type
8-94391-702-0	FCG-008	ISUZU	FORWARD	6HE1	
8-94394-009-2	FCG-009	ISUZU		6K1	
8-94395-254-1	FCG-015	ISUZU	FORWARD	6HH1	
8-94412-030-0	FCG-001	ISUZU	MU	4ZD1	
8-97039-034-0	FCG-013	ISUZU	TROOPER/ BIG FORN	4JG2	
8-97045-151-0	FCG-005	ISUZU		PG32	
8-97069-783-0	FCG-012	ISUZU	MU, WIZARD	4JG2	
8-97130-362-1	FCG-003	ISUZU	TROOPER/ BIG FORN	6VD1	
8-97135-167-0	FCG-004	ISUZU	TROOPER/ BIG FORN	6VD1	
8-97144-874-1	FCG-016	ISUZU	TROOPER/ BIG FORN, MU, WIZARD	4JX1	
8-97145-322-0	FCG-014	ISUZU	ELF 150	4JA1	
8-97148-797-0	FCG-007	ISUZU	ELF 350	4HE1	
8-97222-421-0	FCG-017	ISUZU	TROOPER/ BIG FORN	4JX1	
MD034204	FCM-003	MAZDA	DELICA		
MD104576	FCM-002	MITSUBISHI	FORTE	4G5	
MD108270	FCM-001	MITSUBISHI	DELICA	4G6	
MD361311	FCM-004	MITSUBISHI	DELICA	4G6	
ME065700	FCM-012	MITSUBISHI FUSO	TRUCK	8DC	
ME065701	FCM-010	MITSUBISHI FUSO	TRUCK	8DC	
ME065702	FCM-005	MITSUBISHI FUSO	TRUCK	8DC	
ME075005	FCM-008	MITSUBISHI FUSO	TRUCK	6D1	
ME075013	FCM-007	MITSUBISHI FUSO	TRUCK	6D1	
ME150690	FCM-011	MITSUBISHI FUSO	TRUCK	6D40	
ME400563	FCM-006	MITSUBISHI FUSO	TRUCK	6D1	
ME400564	FCM-013	MITSUBISHI FUSO	TRUCK	6D1	
17120-57B01	FCS-001	SUZUKI	ESCUDO		
17120-60A01	FCS-002	SUZUKI	ESCUDO		
17120-80C00	FCS-004	SUZUKI	JIMNY/ SAMURAI, CULTUS, SA413		
17120-81A00	FCS-003	SUZUKI	JIMNY 1300		
1266574	FCV-005	VOLVO			
1274310	FCV-004	VOLVO			
1274311	FCV-003	VOLVO			
1306259	FCV-001	VOLVO			
1328835	FCV-006	VOLVO			D24
1357433	FCV-002	VOLVO			

Cross Reference List / Free Wheel Hub

Genuine No.	AISIN No.	Make	Model	Body Type	Year
43530-35012	FHT-005	TOYOTA	HI-LUX	RN Series	
43530-35020	FHT-006	TOYOTA	HI-LUX	RN Series	
43530-35021	FHT-007	TOYOTA	HI-LUX	RN Series	
43530-35023	FHT-008	TOYOTA	HI-LUX	LN100, 106, YN100, 105	'88. 09- '97. 08
43530-60013	FHT-011	TOYOTA	LAND CRUISER	FJ	
43530-60014	FHT-012	TOYOTA	LAND CRUISER	BJ60, FJ60	'80. 08- '81. 10
43530-60016	FHT-013	TOYOTA	LAND CRUISER	LJ71, BJ7# FJ62, HJ6#	'84. 11- '90. 01 '87. 08- '90. 01
43530-60030	FHT-015	TOYOTA	LAND CRUISER	BJ41, BJ44	'81. 02- '81. 10
43530-60031	FHT-016	TOYOTA	LAND CRUISER	BJ4#	'81. 10- '84. 10
43530-60042	FHT-002	TOYOTA	LAND CRUISER	HZJ75, HZJ70, 73, 77, KZJ7 Series, HZJ81	'95. 07- '99. 08
43530-60130	FHT-001	TOYOTA	LAND CRUISER	HZJ7 Series	'99. 08- '04. 08
8-94368-363-0	FHG-002	ISUZU	ELF150		
8-97062-018-0	FHG-001	ISUZU	TROOPER, BIG HORN MU	UBS25DW, UBS25GW, UBS69DW, UBS69GW UCS69DWM, UCS55DW, UCS55DWN, UCS17DH	
8-97113-446-1	FHG-005	ISUZU	TROOPER, BIG HORN MU	UBS25DW, UBS25GW, UBS69DW, UBS69GW UCS69DWM	
8-97118-415-0	FHG-003	ISUZU	ELF	NKS60, 70 Series, NKS81 Series	
MB160940	FHM-002	MITSUBISHI	DELICA MONTERO, SHOGUN, PAJERO	L03, L06 Series V10, 20, 30, 40 Series	
MB886389	FHM-003	MITSUBISHI	DELICA MONTERO, SHOGUN, PAJERO	L03, L06 Series V10, 20, 30, 40 Series	
MC865325	FHM-001	MITSUBISHI	CANTER	FD, FG300, 400 Series, FB, FD, FE, FG500, 600 Series	
43810-60A00	FHS-005	SUZUKI	ESCUDO, VITARA, JIMNY SAMURAI		
43810-80011	FHS-002	SUZUKI	JIMNY		

Fan Clutch

Free Wheel Hub

Cross Reference List / Hydraulic Belt Tensioner

Genuine No.	AISIN No.	Make	Model	Engine Type
13540-62020	BTT-001	TOYOTA	Camry	3VZ-FE, V6
13540-62021	BTT-002	TOYOTA		3VZ-FE, V6
13540-65010	BTT-003	TOYOTA	Truck	3VZ-E, V6
13540-70010	BTT-004	TOYOTA		1G-GP
14520-P8E-A011-M4	BTH-002	HONDA		ACURA V6
14520-RCA-A011-M4	BTH-001	HONDA	Accord, Odyssey	3.0/3.5L
MD180051	BTM-002	MITSUBISHI		4G9
MD308086	BTM-003	MITSUBISHI		4G6
MD309999	BTM-004	MITSUBISHI		4G9
MR984375	BTM-001	MITSUBISHI		4G6 2.4L
13068AA051	BTF-002	SUBARU		23A
1271808	BTV-001	VOLVO		VOLVO FF
3517998	BTV-002	VOLVO		VOLVO FF
3531187	BTV-003	VOLVO		VOLVO 740GLT
9135033	BTV-004	VOLVO		VOLVO FF
9146693	BTV-005	VOLVO		VOLVO N2P
9207900	BTV-006	VOLVO		VOLVO N3

Cross Reference List / Timing Chain Cover

Genuine No.	Aisin No.	Make	Application				Component Parts			
			Model	Year	Engine Type	Body Type	Case	Water Pump	Oil Pump	Fan Clutch
11301-17011	TCT-001	TOYOTA	LAND CRUISER	94.08-99.08	1HZ	HZJ75	●	—	●	—
11301-17021	TCT-002	TOYOTA	COASTER	94.08-97.05	1HDT, 1HZ	HDB5#, HZB4#, 5#	●	—	●	—
11301-17030	TCT-003	TOYOTA	COASTER	95.05-97.05	1HDFT	HDB5#	●	—	●	—
			COASTER	97.05-99.07	1H#	HDB5#, HZB4#, 5#	●	—	●	—
			COASTER	99.07-04.08	1HZ	HZB4#, 5#	●	—	●	—
11301-54032	TCT-004	TOYOTA			2L, 3L	●	—	●	—	
11301-56022	TCT-005	TOYOTA	LAND CRUISER	78.11-80.07	B, 2B	BJ4#	●	—	●	—
			COASTER	78.11-80.07	2B	BB1#	●	—	●	—
			DYNA	78.11-80.08	B, 2B	BU2#. 3#	●	—	●	—
11301-56031	TCT-006	TOYOTA			B, 3B	●	—	●	—	
11301-56050	TCT-008	TOYOTA	COASTER	84.08-88.08	3B	BB2#, 3#	●	—	●	—
			DYNA/TOYOACE QUICK	86.01-88.08	B	BU60	●	—	●	—
11301-56060	TCT-009	TOYOTA	LAND CRUISER	85.10-90.01	13BT	BJ71, 74	●	—	●	—
			DYNA/TOYOACE	88.08-89.10	13BT	BU85, 9#	●	—	●	—
11301-56070	TCT-010	TOYOTA			B, 3B	●	—	●	—	
11301-58021	TCT-011	TOYOTA	COASTER	99.05-99.07	3B	BB4#	●	—	●	—
			DYNA/TOYOACE	99.05-02.06	4B	BU301, 1NO	●	—	●	—
			DYNA/TOYOACE	99.05-04.06	4B	BU30#, 346, 03S, 06S, T1, T2,	●	—	●	—
11301-58030	TCT-022	TOYOTA			15B-FT	●	—	●	—	
11301-68011	TCT-012	TOYOTA	COASTER	84.11-85.10	2H	HB3#	●	—	●	—
11301-68020	TCT-013	TOYOTA	COASTER	85.10-90.01	2H, 12HT	HB3#	●	—	●	—
			LAND CRUISER	87.08-90.01	2H, 12HT	HJ6#	●	—	●	—
11301-71010	TCT-067	TOYOTA	CROWN COMFORT	95.12-01.08	3YPE	YXS1#	●	—	—	—
			CROWN COMFORT	01.08-	3YPE	YXS1#	●	—	—	—
11301-75011	TCT-068	TOYOTA	HIACE/REGIUSACE	94.01-95.08	1RZE, 2RZE	RZH10#, 112, 124	●	—	—	—
11301-75021	TCT-069	TOYOTA	DYNA/TOYOACE	00.05-03.06	3RZFPE	RZU300, 20T	●	—	—	—
			DYNA/TOYOACE	00.05-	3RZFPE	RZU301, 300, 30T	●	—	—	—
			DYNA 150/TOYOACE G15	01.07-03.08	3RZFPE	LY230, 280	●	—	—	—
			LAND CRUISER PRADO	02.09-04.08	3RZFE	RZJ12#	●	—	—	—
			HILUX SURF	02.11-04.08	3RZFE	RZN21#	●	—	—	—
			DYNA 150/TOYOACE G15	03.08-	3RZFPE	RZY231, 281	●	—	—	—
			DYNA/TOYOACE	04.06-	3RZFE	RZU300, DM5	●	—	—	—
11301-75050	TCT-070	TOYOTA	DYNA 150/TOYOACE G15	01.07-03.08	1RZE	RZY220, 230	●	—	—	—
11301-76011	TCT-071	TOYOTA	ESTIMA/PREVIEW	94.01-98.01	2TZFE	TCR1#, 2#	●	—	—	—

Hydraulic Belt Tensioner

Timing Chain Cover

Genuine No.	Aisin No.	Make	Application				Component Parts			
			Model	Year	Engine Type	Body Type	Case	Water Pump	Oil Pump	Fan Clutch
11301-76011	TCT-071	TOYOTA	ESTIMA EMINA/LUCIDA	94.01-99.12	2TZFE	TCR1#, 2#	●	—	—	—
11302-35010	TCT-072	TOYOTA	COASTER	84.08-93.01	22R	RB2#	●	—	—	—
11310-66020	TCT-073	TOYOTA	LAND CRUISER	92.08-98.01	1FZFE	FZJ80	●	—	●	—
11320-67010	TCT-015	TOYOTA	LAND CRUISER	93.05-93.08	1KZTE	KZJ7#	●	—	●	—
			HIACE/ REGIUSACE	93.08-99.07	1KZTE	KZH10#, 11#, 12#, 13#	●	—	●	—
			LAND CRUISER	93.09-96.04	1KZTE	KZJ7#	●	—	●	—
			GRANVIA/ GRAND HIACE	95.08-	1KZTE	KCH1#	●	—	●	—
			HILUX SURF	95.11-00.08	1KZTE	KZN185	●	—	●	—
			LAND CRUISER PRADO	96.04-00.08	1KZTE	KZJ9#	●	—	●	—
			REGIUS/ TOURING HIACE	97.04-02.05	1KZTE	KCH4#	●	—	●	—
			HIACE/ REGIUSACE	99.07-04.08	1KZTE	KZH10#, 11#, 120, 13#	●	—	●	—
			11301-31625-71	TCW-001	INDUSTRIAL					●
11310-78151-71	TCW-002	INDUSTRIAL					●	●	—	—

Cross Reference List / Fan Pulley Bracket

Genuine No.	Aisin No.	Make	Model	Engine Type	Reference				
					Component Parts				
					Fan Pulley Bracket	Fan Clutch	Pulley	Gasket	Nut
16307-50011	FBT-001	TOYOTA	CROWN/CROWN MAJESTA	1UZ-FE	●	—	—	—	—
16307-50012	FBT-002	TOYOTA	CROWN/CROWN MAJESTA	1UZ-FE	●	—	—	—	—
16307-50020	FBT-003	TOYOTA	CROWN/CROWN MAJESTA	1UZ-FE	●	—	—	—	—
16307-62011	FBT-004	TOYOTA	T100, TACOMA, 4RUNNER	5VZ-FE	●	●	●	—	●
16307-62021	FBT-005	TOYOTA	HILUX SURF, 4RUNNER, LAND CRUISER PRADO	5VZ-FE	●	●	●	●	●
16307-62030	FBT-004	TOYOTA	T100	5VZ-FE	●	●	●	●	●
16307-62040	FBT-004	TOYOTA	T100	5VZ-FE	●	●	●	●	●
16307-64011	FBT-008	TOYOTA	CORONA	1C	●	—	—	—	—
16307-64012	FBT-009	TOYOTA	CORONA, LITE/TOWNACE TRUCK	2C	●	—	—	—	—
16307-64040	FBT-010	TOYOTA	LITE/TOWNACE NOAH VAN	3C-TE	●	—	—	—	—
16307-65020	FBT-006	TOYOTA	HI-LUX, PICKUP	3VZ-E	●	●	●	●	●
16307-65030	FBT-007	TOYOTA	HI-LUX, T100	3VZ-E	●	●	●	●	●
16307-65040, -65050	FBT-007	TOYOTA	HI-LUX, T100	3VZ-E	●	●	●	●	●
16380-50014	FBT-002	TOYOTA		1UZ-FE, 2UZ-FE	●	●	●	—	●
16380-50034, -50014	FBT-002	TOYOTA		1UZ-FE, 2UZ-FE	●	●	●	—	●
16380-50052, -50070	FBT-002	TOYOTA		1UZ-FE, 2UZ-FE	●	●	●	—	●
16380-50081	FBT-002	TOYOTA		1UZ-FE, 2UZ-FE	●	●	●	—	●
8-97108-785-1	FBG-001	ISUZU	RODEO, TROOPER		●	—	—	—	—
8-97231-718-0	FBG-002	ISUZU			●	—	—	—	—
MD143208	FBM-001	MINI	MONTERO		●	—	—	—	—

ATTENTION:

- Genuine No.'s listed are part numbers for reference only.
- Representative Genuine No.'s may include components that are NOT included with the associated AISIN No.'s.
- AISIN No.'s listed designate part numbers for the Fan Pulley Bracket only.

Timing Chain Cover

Fan Pulley Bracket

Cross Reference List / Flywheel Damper

Genuine No.	AISIN No.	Make	Model	Engine Type	Year
13450-18011	FDT-003	TOYOTA	Land Cruiser	PZJ70	
13450-27013	FDT-002	TOYOTA	RAV4 D4D	1CD	- '05/ 9
13450-27022	FDT-002	TOYOTA	Avensis D4D	1CD	- '02/ 12
13450-70011	FDT-001	TOYOTA	IS200	1G	- '03/ 7

Published on March 31, 2010

Edited and Published by
AISIN SEIKI Co.,Ltd.
Aftermarket Dept.
Sales & Marketing Sector,
Automotive Systems
2-1, Asahi-machi, Kariya, Aichi, JAPAN

Printed in Japan

AISIN
Geared up for the future



**You've been using our products for years...
you just didn't know it ... AISIN**



www.aisinaftermarket.jp

AISIN

Geared up for the future

AISIN SEIKI Co.,Ltd.

AICHI, JAPAN

<http://www.aisinaftermarket.jp>

